

POLITECNICO DI TORINO

Master of Science in Mechatronic Engineering

Master of Science Thesis

**ADAS virtual validation:
ACC and AEB case study with IPG CarMaker**



Supervisor:

Prof. Massimo Violante

Candidate:

Alberto Arcidiacono

Academic Year 2017/2018

Contents

- Abbreviations..... V

- 1 Introduction 1**

- 2 State of the art 3**
 - 2.1 General description..... 3
 - 2.1.1 Adaptive Cruise Control..... 4
 - 2.1.2 Autonomous Emergency Braking 5
 - 2.2 Classification 5
 - 2.3 Legislation 6
 - 2.4 Development process: verification and validation 7
 - 2.4.1 In-the-loop simulations 9
 - 2.5 Testing methodology 11
 - 2.5.1 Scenario elements..... 12
 - 2.5.2 ACC/AEB scenarios and critical situations 14

- 3 Case Study: ACC and AEB..... 17**
 - 3.1 IPG CarMaker..... 17
 - 3.2 ACC/AEB controller logic 24

- 4 Implementation: simulated scenarios..... 33**
 - 4.1 Test quantities..... 33
 - 4.2 ACC tested scenarios..... 34
 - 4.2.1 ACC-T01: ISO 22178 - Vehicles in column: target vehicle cut-out..... 34
 - 4.2.2 ACC-T02: NHTSA - Approaching a preceding vehicle 34
 - 4.2.3 ACC-T03: NHTSA - Changing to a new headway..... 35
 - 4.2.4 ACC-T04: NHTSA - Manually accelerating and near encounter 35
 - 4.2.5 ACC-T05: CTU-F – Lane change vehicle interaction 36
 - 4.2.6 ACC-T06: Zhou paper – Vehicles in column: target vehicle cut-in 36
 - 4.2.7 ACC-T07: Custom – Lane change and cruise speed test 37
 - 4.3 AEB tested scenarios 38
 - 4.3.1 AEB-T01: EuroNCAP CCRs – Approaching a stationary vehicle 38
 - 4.3.2 AEB-T02: EuroNCAP CCRm – Approaching a slower moving vehicle 38
 - 4.3.3 AEB-T03: EuroNCAP CCRb – Following a decelerating vehicle 38
 - 4.3.4 AEB-T04: EU 347/2012 – Approaching a slower moving vehicle 39

4.3.5	AEB-T05: ISO 22179 – Following a decelerating vehicle	39
4.3.6	AEB-T06: CTU-C – Static target encounter after vehicle cut-out.....	40
4.3.7	AEB-T07: Wang paper – Vehicles in column: target vehicle cut-in	40
4.4	Results	41
4.4.1	ACC.....	41
4.4.1.1	ACC-T01: ISO 22178 - Vehicles in column: target vehicle cut-out	42
4.4.1.2	ACC-T02: NHTSA - Approaching a preceding vehicle	47
4.4.1.3	ACC-T03: NHTSA - Changing to a new headway	52
4.4.1.4	ACC-T04: NHTSA - Manually accelerating and near encounter	57
4.4.1.5	ACC-T05: CTU-F – Lane change vehicle interaction.....	62
4.4.1.6	ACC-T06: Zhou paper – Vehicles in column: target vehicle cut-in.....	67
4.4.1.7	ACC-T07: Custom – Lane change and cruise speed test	72
4.4.2	AEB.....	77
4.4.2.1	AEB-T01: EuroNCAP CCRs – Approaching a stationary vehicle	77
4.4.2.2	AEB-T02: EuroNCAP CCRm – Approaching a slower moving vehicle.....	83
4.4.2.3	AEB-T03: EuroNCAP CCRb – Following a decelerating vehicle.....	88
4.4.2.4	AEB-T04: EU 347/2012 – Approaching a slower moving vehicle.....	93
4.4.2.5	AEB-T05: ISO 22179 – Following a decelerating vehicle.....	98
4.4.2.6	AEB-T06: CTU-C – Static target encounter after vehicle cut-out	102
4.4.2.7	AEB-T07: Wang paper – Vehicles in column: target vehicle cut-in.....	107
5	Conclusions	113
	Bibliography	115
	Appendix	121

Abbreviations

ABS	Anti-Lock Braking System
ACC	Adaptive Cruise Control
ACI	Italian Automobile Club
ADAS	Advanced Driver Assistance Systems
AEB	Autonomous Emergency Braking
ASS	Active Safety Systems
CACC	Cooperative Adaptive Cruise Control
CC	Cruise Control
CTU	Czech Technical University
DAS	Driver Assistance Systems
DVA	Direct Variable Access
ECU	Electronic Control Unit
ESC	Electronic Stability Control
ESP	Electronic Stability Program
FCW	Forward Collision Warning
GUI	Graphical User Interface
HIL	Hardware-in-the-loop
HMI	Human Machine Interface
ISO	International Organization for Standardization
LCP	Lane Change Prevention
LCT	Lane Change Task
LDW	Lane Departure Warning
LKS	Lane Keeping System
MIL	Model-in-the-loop
NHTSA	National Highway Traffic Safety Administration
PCC	Predictive Cruise Control
PIL	Processor-in-the-loop
RMSE	Root Mean Square Error
SAE	Society of Automotive Engineers
SIL	Software-in-the-loop
TCS	Traction Control System
V2V	Vehicle-to-Vehicle communication
VeHIL	Vehicle hardware-in-the-loop
VRU	Vulnerable Road User
VUT	Vehicle Under Test

Chapter 1

Introduction

Car accidents causes can mostly be connected to driver distraction or misjudgement [1]. For this reason, the development and implementation of vehicle safety systems have grown, especially in the last decades. The first active safety systems, known as DAS (Driver Assistance Systems), were introduced with the Anti-lock Braking System (ABS) and the Electronic Stability Control (ESC) in the 1970s, and have contributed to reduce the number of road fatalities [2]. Thanks to the technologies advances, the automotive industry increases to adopt sensors and microcontroller in order to perceive environment inputs and to autonomous intervenes on the driving activity. Advanced Driver Assistance Systems (ADAS) are the evolution of the DAS and nowadays are emerging as fundamental to improve road safety.

ADAS are a first step towards autonomous vehicles and as these systems are becoming more complex and safety critical, it is important to analyse the test methods used to validate them. The aim of this thesis is to examine on how to test ADAS, and in particular Adaptive Cruise Control (ACC) and Autonomous Emergency Braking (AEB), by considering aspects such as suitable test environments and traffic scenarios, verification and validation techniques. More specifically, the thesis is arranged in:

- **Chapter 2: State of the art**, starts with an overview of the ADAS functionalities, classification and the current regulations. More specifically, the research focuses on the early stages of ADAS development, which rely on simulations, analysing the differences with the real road tests. The verification and validation procedures together with the testing methodology and the building elements of a scenario are illustrated, with a particular focus on ACC and AEB systems.
- **Chapter 3: ACC and AEB case study**, presents the analysis of the ACC and AEB systems development, with an introduction to the used tools, e.g. IPG CarMaker and Simulink. Moreover, the implemented controller logic is described and explained.
- **Chapter 4: Simulated scenarios implementation**, reviews the driving scenarios used to test the ACC and AEB logic. The tests have been divided into ACC based and AEB based scenarios, and a detailed description of each scenario is given. Moreover, the tests have been parametrized in order to analyse each variation without setting a new scenario for each modification. Finally, the results are evaluated with detailed graphs of each test variation.
- **Chapter 5: Conclusions**, summaries the thesis presenting the limitations of the methodology performed and provides also suggestions for future works.

Chapter 2

State of the art

The goal of this chapter is to provide a review of the state of the art of ADAS and their enabling technologies, including the challenges these involve for controller design and system validation. In Section 2.1 is presented the concept of ADAS, with a description of these systems and their functions, focusing especially on how work the ones under analysis e.g. Adaptive Cruise Control (ACC) and Autonomous Emergency Braking (AEB). Sections 2.2 and 2.3 review the ADAS classification and the current regulations. The development process, together with the verification and validation procedures are discussed in Section 2.4, whereas the testing methodology as well as the building elements of a scenario are illustrated in Section 2.5, including a focus on ACC and AEB critical cases.

2.1 General description

As states the name, ADAS (Advanced Driver Assistance Systems) were born to help and support the driver during his activity by detecting and avoiding hazardous traffic situations. This can be achieved using sensor data and vehicle states in order to control the longitudinal and lateral movement.

The first Driving Assistance Systems (DAS) used were the Anti-lock Braking System (ABS), the Electronic Stability Control (ESC) and the Traction Control System (TCS). These systems are based on proprioceptive sensors, i.e. sensors measuring the internal values of the vehicle, such as velocity, acceleration or wheel rotational velocity in order to help the driver to follow the requested trajectory in the best manner [3].

Advanced Driver Assistance Systems, also known as Active Safety Systems (ASS), are considered as the advancement from DAS [4]. Their main characteristic is the use of exteroceptive sensors, i.e. sensors that acquire information from the outside environment, providing data about the road elements and the traffic vehicles. Examples of ADAS are Adaptive Cruise Control (ACC), Autonomous Emergency Braking (AEB), Electronic Stability Control (ESC), Lane Keeping Assist (LKA), which were first installed in luxury cars, but nowadays they are present in many city cars.

According to [5], 94% of all car crashes are caused by human errors. These include recognition errors, such as driver's inattention or distraction, for a 41%, and decision errors, such as illegal maneuver or misjudgement of the driving conditions, for about 33%. Several studies [6], [7], [8] have shown the benefits of Active Safety Systems, which can improve safety by decreasing the number of traffic accidents. This is achieved because of the reduction in mental and physical resources of the driver, helping him to decrease overall driving effort, stress and human error. ACC and AEB systems are classified as "longitudinal control" ADAS, due to a brake and/or throttle request. Instead, the LKA is a system for the "lateral control" thanks to a steering torque request in case of logic intervention.

2.1.1 Adaptive Cruise Control

The Adaptive Cruise Control (ACC) is the evolution of the Cruise Control (CC), which was first introduced by Mitsubishi in 1995 [9]. After the driver has set the cruise speed through a button, the CC system, acting on the throttle, automatically brings the vehicle to the desired speed. Obviously, this system has a limit: in presence of traffic the driver has to constantly regulate the cruise speed. Mercedes exceeded this restriction in 1999 with the Distronic system, i.e. the first ACC [10]. By using a combination of own vehicle states and exteroceptive sensors, ACC determines the ahead vehicle's velocity and, acting on throttle/brake, it regulates own vehicle's speed to keep a safe distance. The driver can also choose the desired range between the ACC-equipped car and the target vehicle selecting a pre-set time gap. Another used quantity, more important usually for traffic flow purposes, is the time headway. While the time gap is more meaningful for the driver as it is defined as the time interval between the front bumper of the host car and the rear bumper of the target vehicle, the time headway is the sum of the time gap and the occupancy time, defined as the time interval necessary to pass an established point [11]. More specifically, Adaptive Cruise Control benefits are to:

- Improve traffic flow and driving comfort.
- Reduce fuel consumption and trip time.
- Use lower acceleration and deceleration rates than standard non-equipped vehicles, reducing safety critical situations.

Nonetheless, often, the intents of maintaining a safe distance and improving traffic flow by decreasing the distance between vehicles are adverse conditions. Indeed, if the braking is too smooth, a collision might be imminent [12]. On the other hand, a characteristic of the ACC system is to leave too much space from the leading car: this happens because, unlike the driver, the system cannot see over the leading vehicle, and so cannot predict what the preceding car driver will do.

Standard ACC is turned off automatically when the vehicle velocity drops below a certain value (about 30 km/h) and cannot detect stationary objects or pedestrians. ACC systems are therefore broadened with a stop-and-go option, sometimes called 'low-speed ACC', which allows to recognize low-speed traffic actors, such as pedestrians and bicycles, but also city environments and gridlocks.

Another extension of the ACC is the CACC (Cooperative Adaptive Cruise Control), which implements vehicle-to-vehicle communication (V2V). Thanks to this technology, the system can extend its environmental information including data coming from other vehicles. The advantage of CACC, compared to ACC, is that it has an increased control bandwidth and reliability. Thank to this, it allows to maintain a smaller time headway, to reduce system peaks or jerks, and to improve traffic flow and safety [2].

The most recent technology is the Predictive Cruise Control (PCC), which uses the GPS to track the vehicle and to perform the best driving conditions over the next kilometres with the aim of fuel saving and emission reduction. This can be achieved driving as long as possible in the highest gear and, consequently, in the optimal rpm range. As the vehicle approaches the end of a climb, the system maintains a higher gear: in this way less fuel is injected and the vehicle mass itself will move the vehicle over the top. Thanks to PCC, fuel consumption and CO₂ emissions can be reduced by almost 4%, specifically over hilly roads [13], [14].

In conclusion, the ACC is a 'comfort' functionality as it can reduce the workload of the driver during his driving task.

2.1.2 Autonomous Emergency Braking

The goal of Autonomous Emergency Braking (AEB) is to avoid or mitigate collisions due to a driver's lack of attention or misjudgement. This can be achieved identifying potential collisions with objects and vehicles ahead through the mounted sensors.

There are a few sub-types of AEB [15]:

- **City systems**, which focus on low speed crash prevention.
- **Inter-Urban systems**, which work at higher speeds.
- **Pedestrian detection systems**, which rely on pedestrians.
- **Cyclist detection systems**, which focus on cyclists.

Although the working of AEB can vary depending on the vehicle manufacturer, it can be summed in four steps, which describe the general procedure [1]:

1. **Identify critical situations:** AEB determines hazardous situations by using data provided by environmental sensors, such as cameras, radars or LIDAR, combined with information about vehicle states.
2. **Prepare the braking system and warn the driver:** after a critical situation is recognized, the AEB pre-fills the brake circuit with fluid, making contact the linings with the discs. In this way, the system is ready to apply full braking about 30ms earlier, either if requested by the driver or automatically, significantly shortening braking distances. Moreover, the FCW (Forward Collision Warning) system warns the driver that a collision might occur by a combination of both visual and auditory signals.
3. **Soft braking:** if the driver does not respond to warnings and the object ahead is still present, the AEB will apply a light braking in order to make him more aware of the possible danger, with a deceleration request up to -4m/s^2 .
4. **Hard autonomous braking:** if the driver fails to react to the warnings provided, and an unavoidable accident is established due to the position and speed of the ahead vehicle, an emergency brake is activated up to -10m/s^2 . Taking the control of the driving actuators of the vehicle, AEB applies an emergency braking at maximum force in order to avoid, or at least mitigate, the imminent collision, reducing the impact speed and aiming to minimize passenger's wounds.

2.2 Classification

The international Society of Automotive Engineers (SAE) defines six levels of driving automation, from the entirely human level 0 to the totally autonomous level 5. A description of SAE levels is presented in Figure 2.1:

SAE level	Name	Execution of Steering and Acceleration/Deceleration	Monitoring of Driving Environment	Fallback Performance of Dynamic Driving Task	System Capability (Driving Modes)
0	No Automation	Human driver	Human driver	Human driver	n/a
1	Driver Assistance	Human driver and system	Human driver	Human driver	Some driving modes
2	Partial Automation	System	Human driver	Human driver	Some driving modes
3	Conditional Automation	System	System	Human driver	Some driving modes
4	High Automation	System	System	System	Some driving modes
5	Full Automation	System	System	System	All driving modes

Figure 2.1: SAE levels classification [16]

ACC and AEB are classified as level 1. This means that they can actually conduct some parts of the driving task, whereas the driver continues to supervise the external environment and he is responsible in case of system failure or malfunction. Moreover, the human driver is responsible for intervening and taking control of the vehicle in situations when the working area of the automated system is exceeded, since the system cannot perceive its performance envelope and limits [17]. For these reasons, the driver, in the ACC system, can choose different time gap intervals according to the real-time observed driving environment and, in general in every ADAS, he can override the system intervention in every moment by one of the following methods: braking, acceleration, activation of the turn signal or turning of the steering wheel to a collision-free path.

2.3 Legislation

For what concerns the automotive markets, ADAS are not under homologation in Europe. Indeed, EU regulations 661/2009/EC, 347/2012/EC and 351/2012/EC state only Electronic Vehicle Stability Control (EVSC) mandatory for all new road vehicles and Lane Departure Warning Systems (LDWS) and Advanced Emergency Braking System (AEBS) mandatory for all heavy-duty vehicles and busses [18].

However, there is the European New Car Assessment Program (Euro-NCAP), which is a voluntary vehicle safety rating system backed by the European Commission.

Euro NCAP is a performance assessment programme where the safety of vehicles are assessed by a five stars rating system [19]. Currently, Euro NCAP have released protocols for the following four areas: adult occupant protection, child occupant protection, pedestrian occupant protection and safety assist.

In the last protocol, the following types of ADAS functions are presented:

- Speed Assist Systems
- AEB Inter-Urban Systems
- Electronic Stability Control
- Lane Support Systems
- Seatbelt Reminders

On the other hand, the International Organization for Standardization (ISO) is a certification organization, which work is to prepare International Standards, and it is normally accomplished by ISO technical committees.

Regarding ADAS, ISO documents contain “the basic control strategy, minimum functionality requirements, basic driver interface elements, minimum requirements for diagnostics and reaction to failure, and performance test procedures” [20].

The reference ISO for ACC systems is the ISO-15622, while the one for the AEB systems, included in the Forward Vehicle Collision Warning systems, is the ISO-15623.

As it is possible to understand, ISO standards are type-approval only if there is a European regulation, but nevertheless car makers usually develop ADAS functionalities according to ISO specifications. A summary with the roadmap of Euro NCAP protocols and EU regulations can be seen in Figure 2.2.

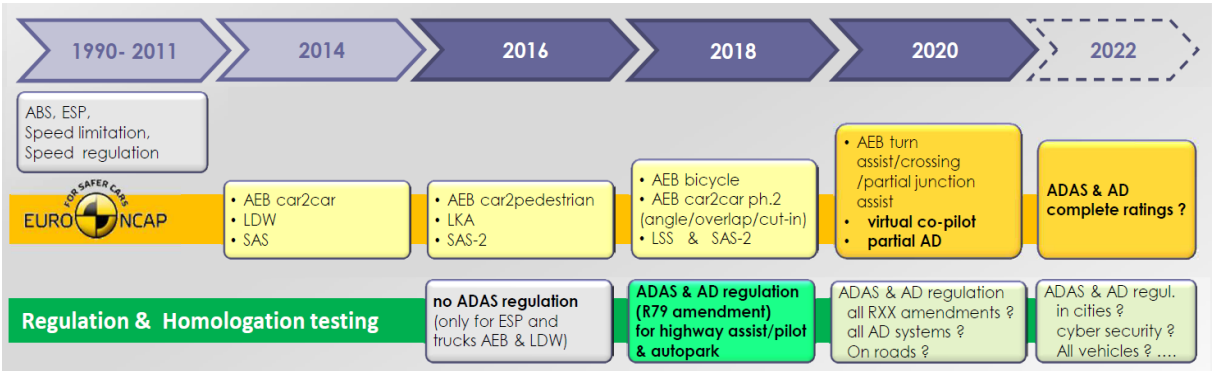

Figure 2.2: Euro NCAP protocols and EU regulations roadmap [21]

2.4 Development process: verification and validation

In the automotive business, the management of the different phases in the production of safety-critical mechatronic systems is often connected using the ‘V’ cycle diagram. As depicted in Figure 2.3, this diagram uses a top-down procedure for design and a bottom-up procedure for validation, even if in reality the production process does not rigorously pursue all the steps in this order, but usually passes over several iteration loops.

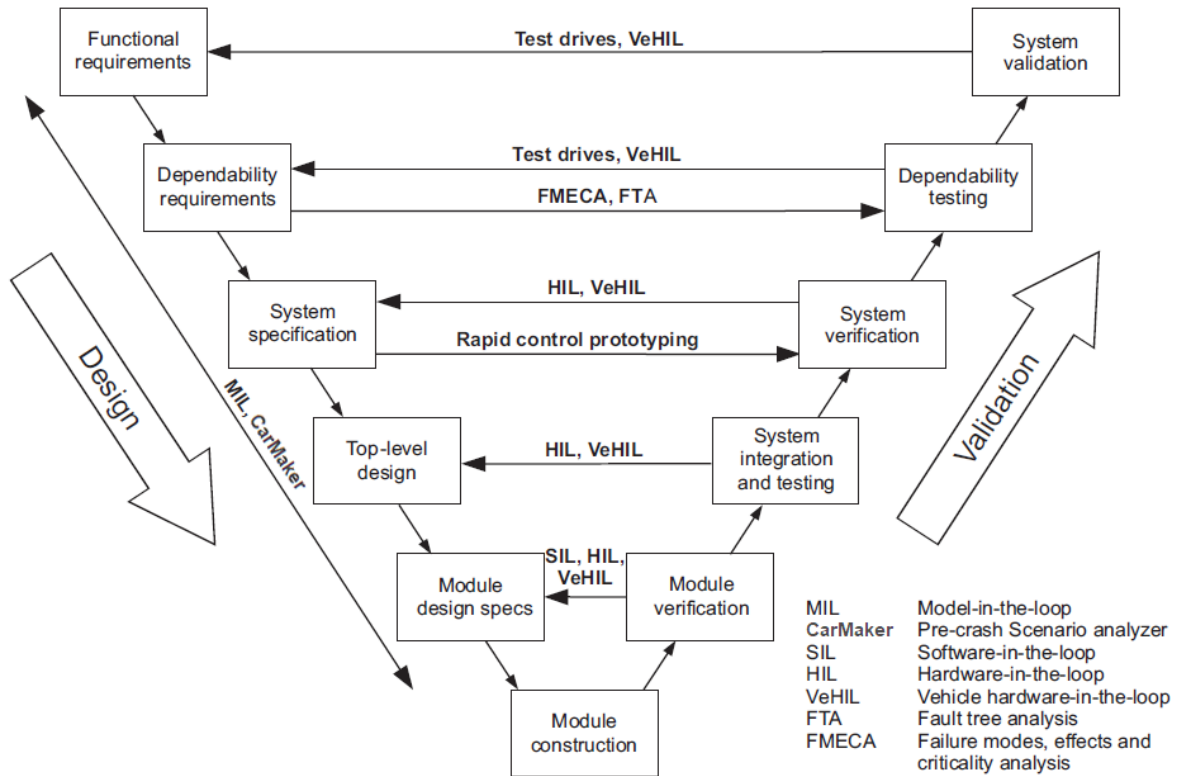

Figure 2.3: V diagram [2]

During each testing phase it is important to check if the output satisfy its specification. This procedure is called ‘verification’, and could be conducted, for example, to test the range, accuracy and precision of the environment sensors, but also to guarantee integration with other model subsystems [2].

Since verification only establishes the correct conformity between phase output and model specification, if an error is present in such specification, this could lead to a defective product. Moreover, if after the design process a fault is identified, it is more difficult to look for the main cause, risking also to reach to an incorrect conclusion. For this reason it is important to implement ‘validation’ of the system under test against its requirements, in particular for type approval and certification intentions.

However, the validation of a fault-tolerant model against its reliability requirements it is not so easy. Indeed, testing all the potential failure elements and reproducing every test conditions under which the control system acts is a very time-consuming process.

As a result, only a partial estimation of the system reliability can be afforded without a physical prototype, and, therefore, after the proper corrections given by the results of verification and validation phases, the development process is repeated for another cycle, reiterating the tests. It has been evaluated that verification and validation of an ADAS system could cost up to 50% of the total development budget [22] and so, for this reason, car makers’ aim is to reduce the number of times a test is performed to accelerate the process.

During the early stages of ADAS development, the product is first modelled and tested using simulators. Virtual testing have absolute repeatability, using the same conditions every time and without damaging the hardware. Moreover the full availability of hardware model enables complete fault injection, additional debugging and monitoring capabilities during tests. Even if simulations add additional costs (tools, developers, computational resources), virtual testing is much less expensive than real-life road tests, since a single physical test is worth around a

thousand virtual tests [23]. Another aspect is the increasing safety-critical functionality of ADAS e.g. these systems can perform actions that endanger drivers and other road users but can also cause significant material damages and so should not be tested on roads before extensive simulations have verified that the functions are reliable [1].

However, simulations can dawn before a physical prototype or even before the design is fully finished, and therefore models depend on data collected from developmental testing of the current process or from similar previous systems. Because of this, a simulation often cannot determine "unexpected" failure modes, ones that are typical of physical testing [24]. Moreover usually virtual simulators have incompatible interfaces between different tools, it's difficult to integrate models of different vendors [25] and, as says Karim Mikkiche, Alliance Global VP for vehicle customer performance, digital simulation and tests of Renault group, "digital techniques are not yet capable of precisely modelling all vehicle parameters, such as the way lighting conditions might affect a detection camera or the dispersion response of a braking system". Another limit of the simulators is that it is difficult to foresee the behaviour of the new used materials (that are appearing in the automotive field replacing the conventional ones) under stress conditions but also the more the design is complex, the more difficult is for the simulator to get proper results, since its accuracy is based on computational capability [26]. So even if most of the times virtual tests have a significant part in the system development process whereas physical tests are only used for checking assumptions and calculations done virtually, it is likewise clear that a simulation cannot fully replace a physical test [23].

2.4.1 In-the-loop simulations

To design and validate ADAS control system, different 'in the-loop' simulation techniques are present in the automotive field, in order to have fast, flexible, and repeatable tests.

The first set up and the initial testing of the ADAS is fulfilled by model-in-the-loop (MIL) simulations, where the plant (car) and the controller (system logic) are reproduced on a PC. Simulation software, like CarSim, CarMaker, PreScan, etc., are used to test the model in various scenarios. Usually all these programs contain:

- **Environment elements:** roads, buildings or other street objects.
- **Traffic actors:** cars, trucks, motorcycles, etc., but also pedestrians and other road users.
- **All the devices and the dynamics of the vehicle under test:** every car element is modelled, from the sensors to the car tyres.
- **A module containing the actual ADAS logic,** including sensor processing and behaviour actions. This component can also be implemented using Matlab/Simulink, exporting it in a run-time environment. Thanks to this extension, the desired ADAS controller can be developed, while the plant is represented by the parameters given by the simulation program.

To achieve this thesis objectives, it was decided to use IPG CarMaker software, and its detailed characteristics are illustrated in Chapter 3.

After MIL simulations have given significant results, the controller software code can be obtained and compiled using automatic code generation. In this phase, called software-in-the-loop (SIL), the real code is developed and tested depending on the processor or FPGA that will

be used for the final hardware implementation. At this point, plant and controller are still simulated in the PC with software models.

Once the controller has been validated with SIL simulations, the developed code is loaded in the actual processor/FPGA. In this way, during the processor-in-the-loop (PIL) phase, the ADAS controller is tested with real-time hardware, whereas the plant is still simulated in the PC. As for any step, if during a phase errors or faults are faced, it is necessary to go back to the previous stage, otherwise you can proceed with the successive procedure.

Hardware-in-the-loop (HIL) simulation can be considered one of the most important step in ADAS control tests, since during this phase the whole system runs in real-time hardware. The components can be real (as for the controller that can be the actual ECU) or emulated (as for the plant, replacing the vehicle with a peripheral that has the same input and output characteristics). In this way, the hardware validation can take place before a prototype vehicle is ready, since any additional vehicle element can be simulated. Before implementing the ADAS on an actual car, HIL simulation allows to combine the flexibility and the repeatability of a simulation with a safe and reliable hardware. Moreover, the test can be conducted without any influences from other separated systems, while the model logic accuracy can be evaluated by controlled introduction of disturbances, called fault injection.

As already explained in Section 2.4, physical tests are often expensive, time consuming and difficult to repeat with the same conditions. A solution to combine the advantages of virtual simulations with the ones of real test drives, can be described by the Vehicle hardware-in-the-loop (VeHIL). As it is shown in Figure 2.4, VeHIL can be performed in an indoor laboratory, where some real vehicles are present. The vehicle under test is set up on a chassis dynamometer, while ahead is placed another car, which can be represented by a specific robot-moving base. All the vehicle sensors are present, collecting relative motion data between the two cars, and combining them with the absolute motion of the actors in a real-time traffic scenario, which is projected on a display in front of the vehicle under test. Also, different Human-Machine Interfaces (HMI) can be used to show the output of the system.



Figure 2.4: VeHIL testing laboratory [2]

2.5 Testing methodology

The proposed methodology is useful to identify the different elements that need to be examined when arranging test cases [1]. The steps are:

1. **Define the objectives:** define which system or which part of it needs to be tested, together with defining the working field and the goal of the system under analysis.
2. **Consider the parameters of interest:** define which parameters can influence the testing. Elements to consider are: type of road, traffic environments and actors, weather, location, which sensors are used but also interaction between other systems.
3. **Run test cases:** arrange the test cases that should be considered. It is important to analyse and select few scenarios which involve the much of the ADAS's functionalities, in order to have an easy, fast and repeatable test development. However, test cases having less common traffic situations and scenarios that might cause false positive errors should also be examined.
4. **Evaluate the results:** verify if the tests results are acceptable by comparing them with the system specifications and, if necessary, correct and redesign the scenarios. The test scenario is “passed” if the system behaves as expected or in an opportune way to solve the situation. A way could be the use of the Root Mean Square Error (RMSE) and the coefficient of determination. The RMSE is defined as “the sampled standard deviation between varied dataset and a nominal dataset” [17], while the coefficient of determination is “a metric of the quality of a data fit with respect to a nominal dataset” [17]. The more the values are close to 1, the less is the deviation between the output test data and the nominal dataset.

During the development of test cases, usually several vehicle functionalities are examined. In the first part of vehicle testing, the focus is on testing the sensors: radar tests verify the accuracy by reading the output data, while camera tests are about object recognition and road markings detection algorithms. Other tests are performed to verify that the ADAS turns off in presence of defective sensor inputs, caused by faults, interfering objects or low visibility conditions. In the second part, the ADAS and its internal components are tested. This includes provoking ADAS activation and false positive errors in order to verify if the ADAS logic performs correctly in different scenarios and if the driver can deactivate the system in case of malfunction (or for any other reason).

Another key objective is to solve HMI (Human Machine Interface) conflict situations. This includes strife between different systems interacting with the user as well as issues between this interaction and the driving situation. Moreover, executing only ADAS individual tests when implementing new functions might be not enough, because even if the system works as required, the interaction between already implemented and new ADAS functions might cause unpredicted failures.

For example, it is considered a vehicle with both AEB and LCP (Lane Change Prevention) active (Figure 2.5). In the traffic scenario proposed, three vehicles are driving in the same direction with the same velocity, when suddenly vehicle 3 brakes hard. The surprised driver in vehicle 1 might behave in two different ways to avoid the collision: he could brake hard too or could change lane if he isn't aware of vehicle 2 presence.



Figure 2.5: AEB and LCP interaction scenario [1]

If the driver in vehicle 1 tries to change lane, the AEB is disabled by user's steering, but the LCP activates due to vehicle 2, so vehicle 1 is still in lane 1 and a possible collision between vehicle 1 and 3 might occur.

2.5.1 Scenario elements

ACC and AEB controller usually consider a best-case scenario (dry road, high visibility, sun light, etc.), but in the reality there are many elements that could change this optimal situation. For example, the road could be bumpy and dirty or wet and slippery, the tyres could be old and consumed, the car could be extra carried with goods or dragging a trailer [15].

If the system has been developed not considering these elements, then, in case of braking, the stopping distance will definitely increase, undermining the efficacy of the ADAS.

As a result, the tyre-road friction coefficient is an important parameter which affects the real-time maximum deceleration and, consequently, the vehicle driving safety. This parameter can be estimated using two methods: direct detection through sensors and evaluation by vehicle dynamic model. Direct detection approach is performed using optical or acoustic sensors, but this method is not so much used due to the cost of these sensors. Moreover, its dependability and accuracy are low, because the detection precision changes depending on the climate and the surroundings. On the other hand, vehicle dynamic model estimation has higher robustness, but the accuracy still needs to be improved.

Recent studies [27] are focusing on combining the latter method with data coming from multiple sensors, in order to increase estimation accuracy. Some researches [28] have focused on estimating the mean coefficient value of vehicle four wheels using slip-slope, Kalman filter and lateral dynamics methods, but recent studies have shown that the friction coefficient is better estimated on individual wheels [29].

Another problem is concerning sensors danger recognition. ADAS use radars (or rarely LIDAR) and cameras to perceive environment inputs, but cameras performance can be weakened by sunlight, fog or at night, while radars have problems if the objects are too smalls. Moreover these systems are designed to activate only if a certain hazard situation is detected, avoiding marginal circumstances and preventing false alarms [15]. AGILE and AIDE consortium members have divided the scenarios building elements in three categories:

1. **Road type and status, environment conditions:** including the type of road (city road, highway, motorway, rural) and its status (smooth, bumpy, slopped, icy) but also visibility and weather conditions (sunlight, fog, rain).
2. **Traffic type and actors:** including traffic situations and actors (traffic in the same direction, oncoming traffic, crossing or intersection traffic) but also the presence of vulnerable road user (VRU) summarized with pedestrians.

3. Trajectories due to driving behaviour: including actions related to the driving task (car following, use of mirrors) and other activities analyzed to measure driving performance and workload (Lane Change Task (LCT), overtaking manoeuvres, distraction tasks, object and event detection outside the car).

The average ratings, given by all the consortium members about the scenarios elements just presented, are reported in Figure 2.6. The possible scores are on a scale from 1 to 3, where 1 is “very relevant”, 2 is “quite relevant” and 3 “not relevant”. Different colours are used.

General means in the ratings																		
Possible Scenarios	Road type and status, environment conditions						Traffic type and actors						Trajectories due to driving behaviour					
	Type of road: city roads	Type of road: highways	Type of road: motorways	Type of road: rural	Road conditions	Visibility conditions	Weather conditions	Traffic in the same direction	Oncoming traffic	Crossing traffic	Pedestrians	Platoon driving	Car following	Lane Change Task (LCT)	Overtaking manoeuvres	Distraction task	Object and event detection outside the car	Use of mirrors
ADAS:																		
Lateral Control	2	1	1	1	1	2	2	3	2	3	3	2	1	1	1	2	1	2
Lane Keeping and warning	2	1	1	1	1,5	2	2,5	2	2	2	2	2,5	1,5	2	2	1,5	2,5	2
Blind spot monitoring	2	2	2	2	3	1,5	2	1,5	2	1,5	2	3	1,5	1	1,5	2	2	1
Lane change and merge collision avoidance	2	1	2	1	2	2	2	2	2	1	2,5	2,5	2,5	1,5	2,5	1,5	1,5	2
Longitudinal Control	2,5	2	2	2	3	2	2	1	2	2	2	3	1,5	2	3	2	1,5	2
Adaptive Cruise Control	2	1	1	1	2	1	1	1	1	1	3	2	1	3	3	2	3	3
Road Low Friction Warning Systems	1	2	1	1	2	2,5	2	3	2	2,5	1	2	1	2	1	2	2	1
Reversing/Parking Aid	1	3	3	3	3	1	3	3	3	3	2	3	3	3	3	3	1	1
Vision Enhancement	3	2	2	1	2	1	1	2	2	2	1	3	2	3	3	2	1	3
Driver Monitoring	3	1	1	1	3	2	3	2	2	3	3	2	2	3	3	3	2	3
Pre-Crash Systems (AEB)	2	1	1	1	2	1	1	1	1	1	1	2	1	3	3	2	1	3
Vulnerable Road Users Protection Systems	1	2	3	1	3	1	1	2	2	2	1	3	3	3	3	1	1	1

Figure 2.6: AIDE rating on ADAS [30]

ACC and AEB ratings are highlighted in yellow. As it is possible to see, the most important elements are high-speed roads, traffic conditions, visibility and weather conditions.

Using both the ACC, which, being a comfort system, is mostly used on highways rather than city roads, and the AEB in high speed roads, increases the dangerousness of a potential hazard situation, as the possible impact force is bigger, as well as larger the distance to stop the vehicle. Moreover, these systems act in scenarios with other vehicles, so the possibility of a hazard situation increases with more traffic actors. In addition, visibility and weather conditions could also produce issues both for the sensors fooled by incorrect inputs and for the capability to stop the vehicle in a safe time. Furthermore, AEB, which is often used in city environment with pedestrian presence, has also a relevant score in such field.

Not relevant are the conditions of lane changing because, as already stated before, ACC and AEB are “longitudinal control” systems and so do not act on the steering wheel.

2.5.2 ACC/AEB scenarios and critical situations

The possible scenario configurations for ACC and AEB systems are: free-flow, car-following, cut-in, cut-out, lane-change, approach, separate. These test cases have been reviewed by [2] and are based on different crash databases such as NHTSA, CAMP and SAVME. A summary is presented in Figure 2.7, where are listed the scenario type, the description, the velocity profiles of the target vehicle $i-1$ (grey line) and host vehicle i (black line), including the distance between the vehicles.







Scenario top view	Description	Scenario plots of velocity and distance	
	Vehicle i has no preceding vehicle.		
	Vehicle i is following vehicle $i-1$ with a constant velocity.		
	Vehicle $i-1$ moves in front of vehicle i from an adjacent lane.		
	Vehicle $i-1$ moves out of the lane of vehicle i to an adjacent lane.		
	Vehicle i changes to an adjacent lane.		
	Vehicle i drives towards vehicle $i-1$ in the same lane.		
	Vehicle $i-1$ drives away from vehicle i in the same lane.		

Figure 2.7: ACC and AEB scenarios classification [2]

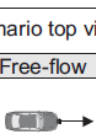
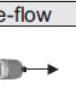
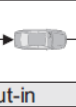
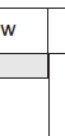
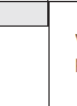
The critical configurations are especially the cut-in scenario (when a vehicle from an adjacent lane moves in front of the host vehicle) and the approach scenario (when host vehicle drives towards another vehicle in the same lane), but besides, a hazardous situation could occur when the system loses the target in a curve.

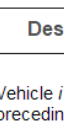
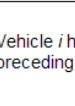
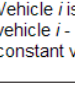
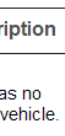
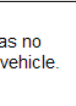
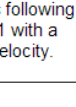
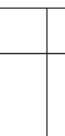
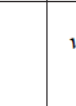
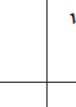
The seriousness of the above scenarios it is also influenced by the traffic situations, summarized as free flow, bottleneck, congested traffic, upstream and downstream front [29]. A free flow traffic condition is when the vehicles density is small enough, so that interactions between vehicles are negligible, and therefore their speed is not restricted by other road users. When in a free flow condition the vehicles density increases, the average vehicles speed decrease, resulting in congested traffic. The congested model is divided from free flow by the upstream and downstream fronts: in the upstream front, vehicles decelerate, moving from a free flow condition to a congested pattern, while on the contrary in the downstream front, vehicles accelerate, moving from a congested pattern to a free flow condition. Traffic congestion occurs often due to bottleneck conditions, such as road works, a reduction of road lanes, accidents, bad weather conditions etc. [31].

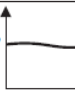
While for ACC systems currently there are no type-approval scenarios, for what concern AEB systems some institutions provide precise test cases. For example, Euro NCAP specifies tests which are conducted on a dry (with ambient temperature above 5°C and below 40°C, no precipitation and wind speeds below 10m/s), natural ambient illumination, uniform, solid-paved surface (not contain any irregularities e.g. large dips or cracks, manhole covers or reflective studs) with a consistent slope between level and 1%. Moreover the test surface shall have a minimal peak braking coefficient (PBC) of 0.9 [32].

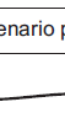
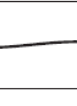
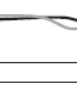
Dividing AEB in AEB City systems, which work between 10-50km/h, and AEB Inter-Urban systems, which work between 30-80km/h, Euro NCAP defines three test scenarios, described in Figure 2.8.





Test type		Illustration	Test description
CCRs CITY Stationary low speed	Car drives into stationary vehicle (low speed)		Approaching a stopped vehicle at test speeds from 10 to 50km/h in 5km/h increments.
CCRs INTER-URBAN Stationary high speed	Car drives into stationary vehicle (high speed)		Approaching a stopped vehicle at test speeds of 30 to 80km/h in 5km/h increments.
CCRm INTER-URBAN Slower moving	Car drives into slower moving vehicle		Approaching a moving target at 20km/h. Test vehicle speed 30km/h up to 80km/h in 5km/h increments.
CCRb INTER-URBAN Braking	Car drives into braking vehicle		Approaching a decelerating target, both vehicles initially moving at 50km/h. Target car has two headway conditions (short 12m and long 40m) and two braking levels (normal 2m/s ² and emergency 6m/s ²).

Figure 2.8: Euro NCAP test scenarios [33]

All these scenarios test nose-to-tail (or rear-end) accidents, that are collisions where the front of a vehicle impact with the rear of the other. Moreover, as it is shown in the Figure 2.8, AEB City systems are tested only on CCRs scenario, while AEB Inter-Urban systems in all three cases.

Chapter 3

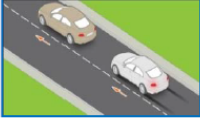
Case Study: ACC and AEB

The goal of this chapter is to provide an overview of the used software to develop the analysis of ACC and AEB systems. Section 3.1 presents an introduction to IPG CarMaker tool. A general description of the software characteristics is presented, as well as the options used to achieve the thesis objectives. The implemented ACC and AEB controller is described in Section 3.2, where it is explained how the logic works and how it was build using Simulink.

3.1 IPG CarMaker

The software that was used to fulfil the thesis objectives is CarMaker, by company IPG Automotive, which is a simulation tool that can be used for testing light-duty vehicles in virtual realistic environment during each phase of the in-the-loop development process. The company provides also other software, like TruckMaker or MotorcycleMaker, which are adopted to test respectively heavy-duty vehicles (such as trucks, busses and special vehicles) and motorized two-wheelers. CarMaker is a test platform which allows to recreate real-world test scenarios in a virtual environment, simulating every type of road and traffic, and performing realistic execution through the event and maneuver-based testing method [34]. Moreover, IPG software include a complete vehicle model, with the possibility to change many elements of vehicle dynamics, and an intelligent driver model, in which it is possible to modify the driver's behaviour (defensive, normal, aggressive, etc...).

CarMaker is based on fixed models (vehicle, suspension, tires, etc.), called *data set*, whose properties can be varied. Once a data set is selected, it is possible to launch a *TestRun*, which represents a test scenario in which all parameters of the virtual environment (vehicle, driver, road, maneuver, etc.) are sufficiently defined.

The main window, called GUI (Graphical User Interface), is shown in Figure 3.1.

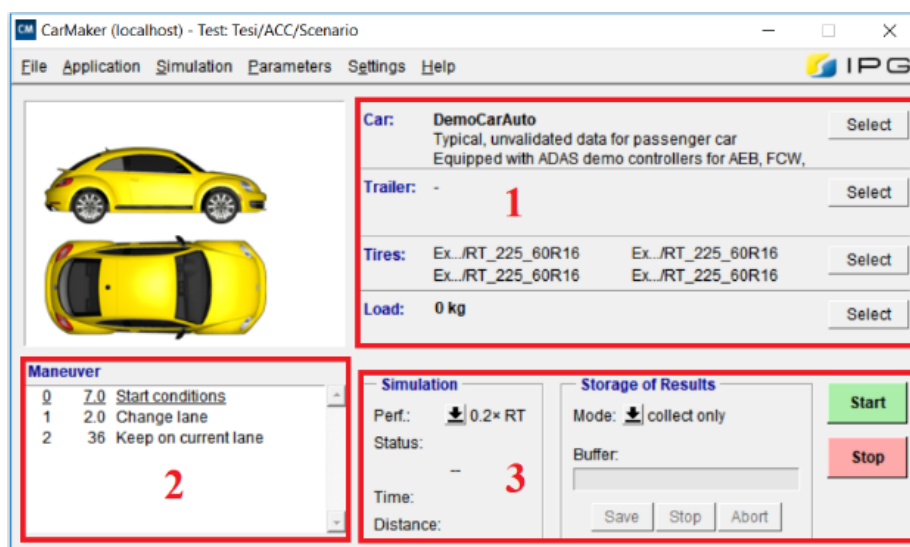

Figure 3.1: IPG CarMaker GUI

GUI features, highlighted in the previous Figure, are:

- 1. Car, Trailer, tires and load selection.
- 2. Maneuvers box.
- 3. Simulation status and storage results options.

The car used for the test is the “DemoCarAuto”, based on the “DemoCar”, that is a Volkswagen Beetle adopted also by IPG for EuroNCAP tests. The car dynamic was maintained, except for the gearbox, which was changed from manual to automatic.

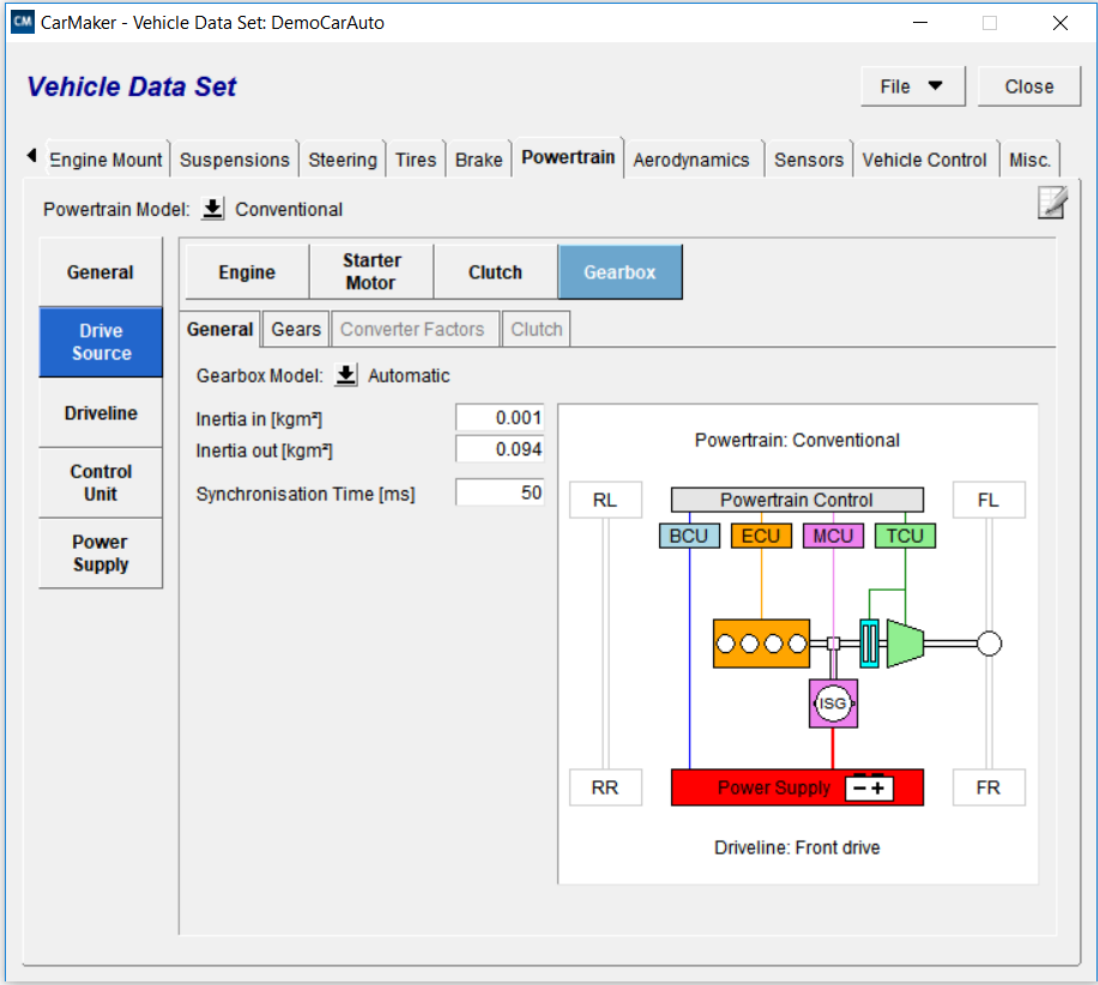

Figure 3.2: IPG CarMaker powertrain setting

Moreover, an object sensor called “RadarL” was added in order to detect traffic actors, with the characteristics shown in Figure 3.3.

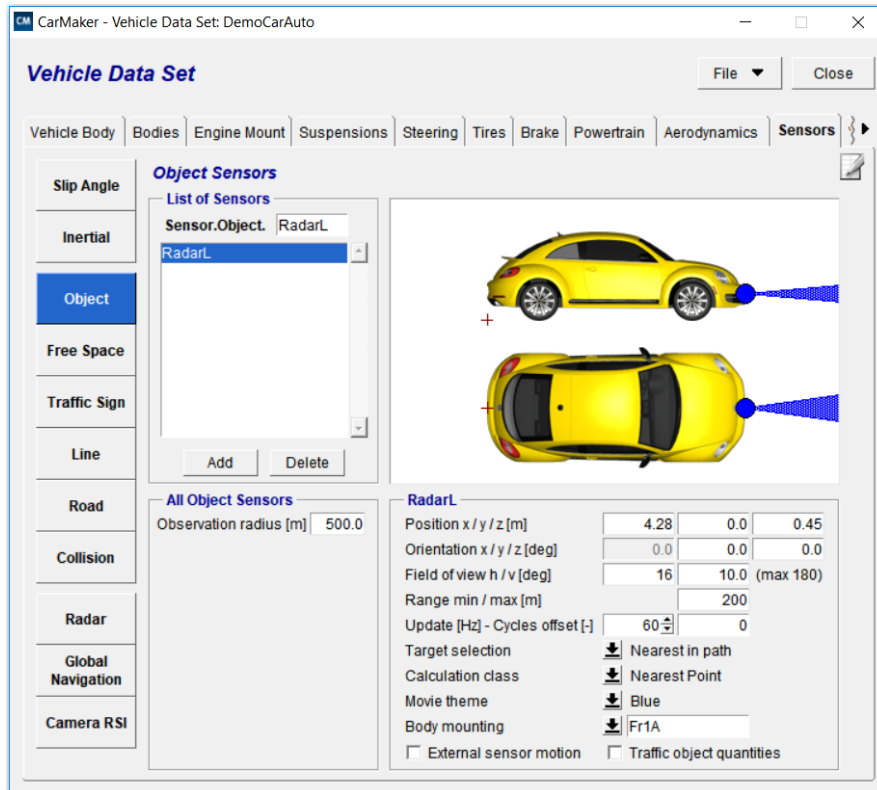

Figure 3.3: IPG CarMaker sensor characteristics

The ACC and AEB logic was developed in Simulink, and in order to make communicate the two programs it was necessary to set a Control Model of “Acceleration Control + ACC” with DVA (Direct Variable Access) approach.

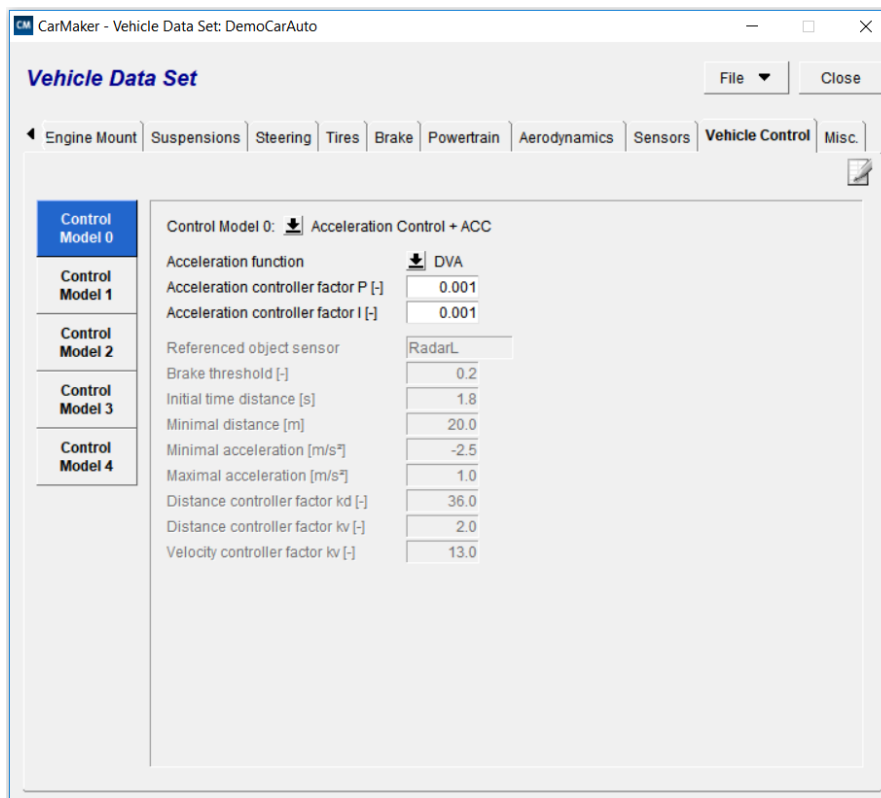

Figure 3.4: IPG CarMaker vehicle control model

The interaction between CarMaker and Simulink is possible thanks to a “DVAwr” command, that writes in the CarMaker data dictionary the desired variable value, which is then read through the “Read CM Dict” Simulink block. A better explanation is given in Section 3.2. All the commands are located in the maneuver box, as shows Figure 3.5.

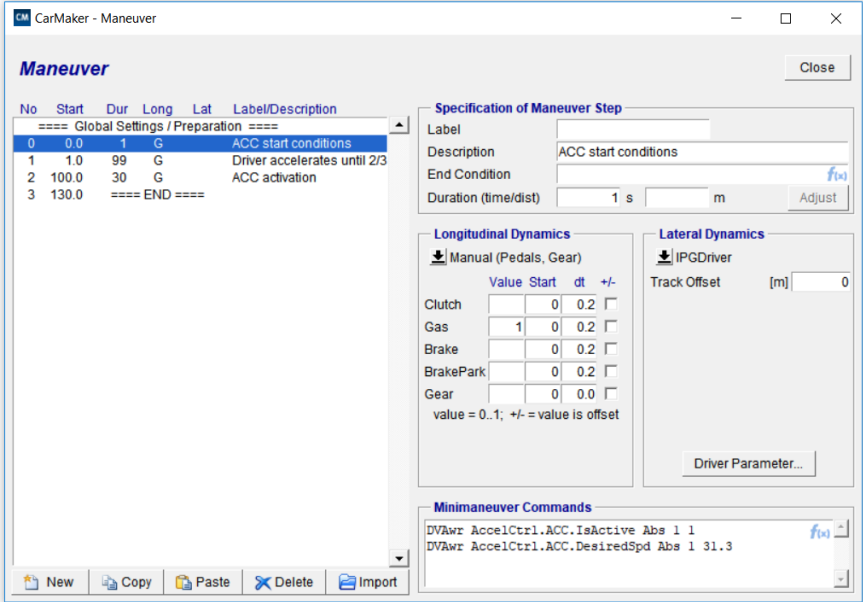

Figure 3.5: IPG CarMaker maneuver window

Another important parameter is the traffic section. Here it is possible to set static or moving traffic object, selecting a predefined model of car, truck, motorcycle or pedestrian (including bicycle and animals) and eventually changing the motion model parameters and the maneuvers. The various traffic situation scenarios are better explained in Chapter 4.

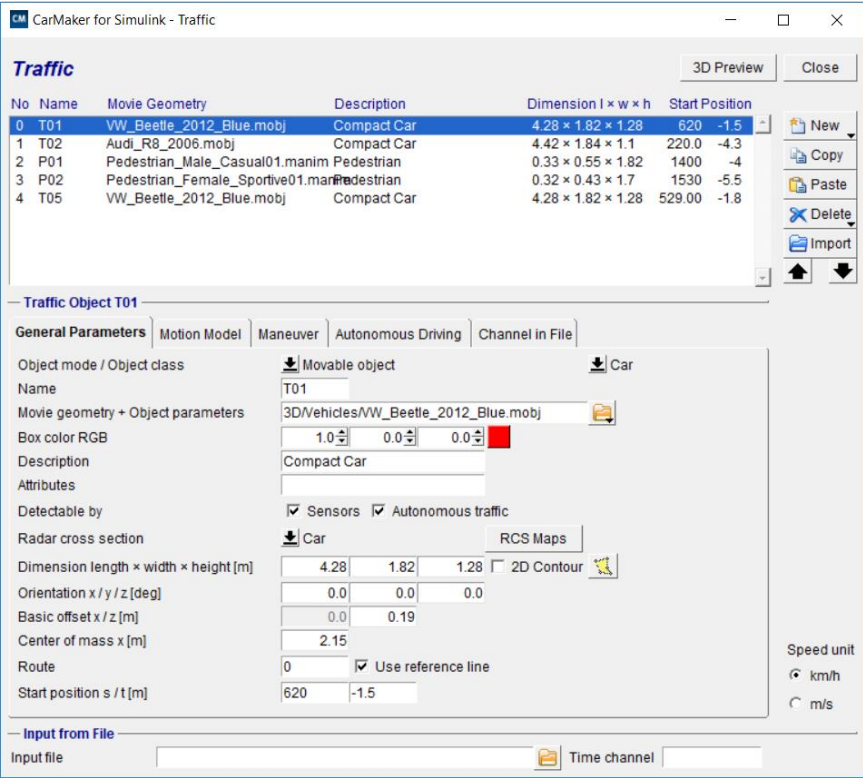

Figure 3.6: IPG CarMaker traffic window

CarMaker offers the possibility to create an own scenario, based on the editor options, which include the type of road (straight, turn, junction, slope, bump), the accessories (traffic light, sign or barrier) and the scenery (bridge, tunnel, environment objects).

The road used for the tests is a simple two lanes straight road, because of the scenarios implemented that involve rear end collisions. A panoramic is shown in Figure 3.7.

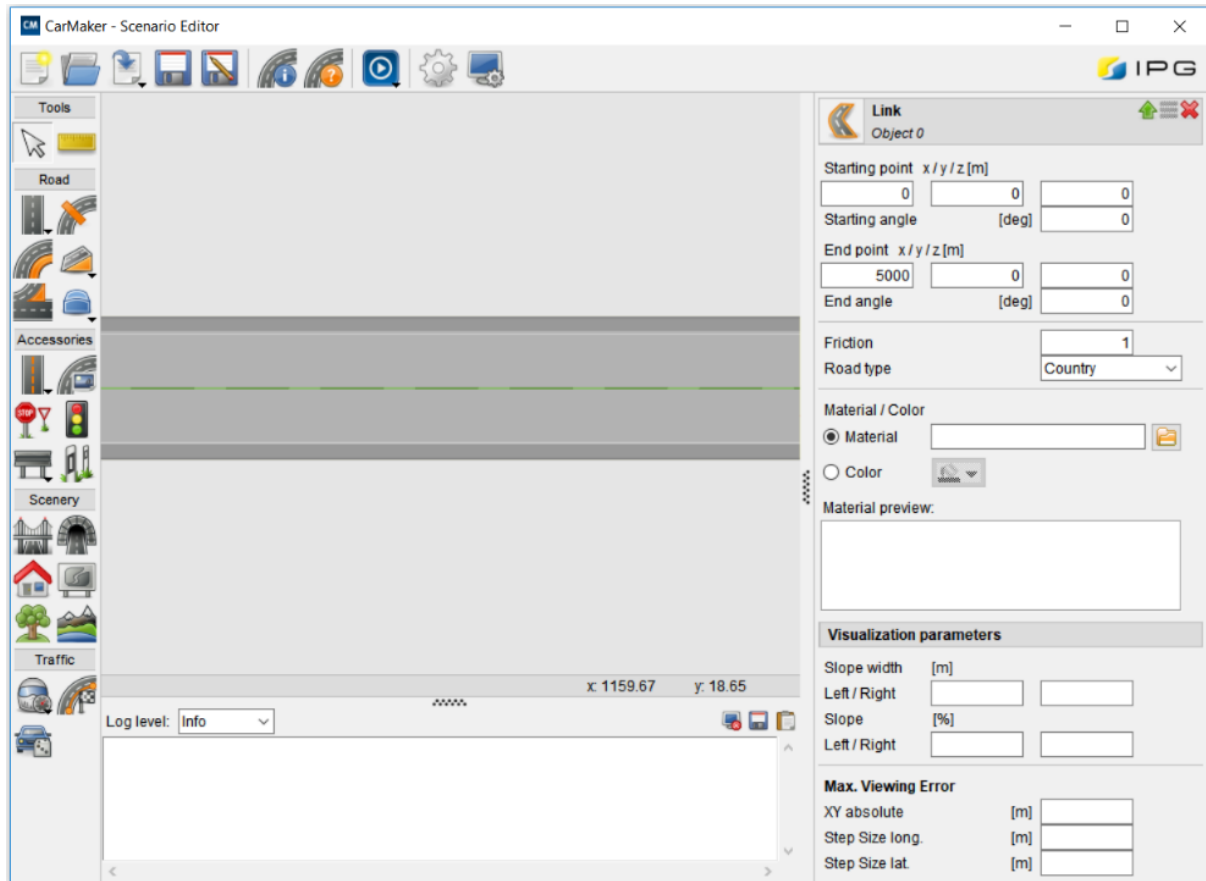

Figure 3.7: IPG CarMaker scenario editor window

Another important feature of CarMaker is the Test Manager, which it is used to parameterize the test scenarios. The test automation tool executes the *test series*, which are the union of TestRuns, “variations” and other options, starting from top to bottom.

The main advantage of the Test Manager tool is to enhance the preparation, execution and analysis of the scenarios under test. Thanks to the “variations” it is possible to modify the parameters of a TestRun, instead of creating a TestRun for each test case. Moreover, it is possible to add script files to define certain actions, to define test pass criteria in order to judge the results of a simulation immediately thanks to a visual (green, yellow, red) mark, to display custom diagrams and other options. After all the test series have been performed, it is possible to see all the results through a complete report.

An overview of the Test Manager window is given in the Figure 3.8, where it is reported the test series of the ACC-T02 scenario, described in Section 4.2.2.

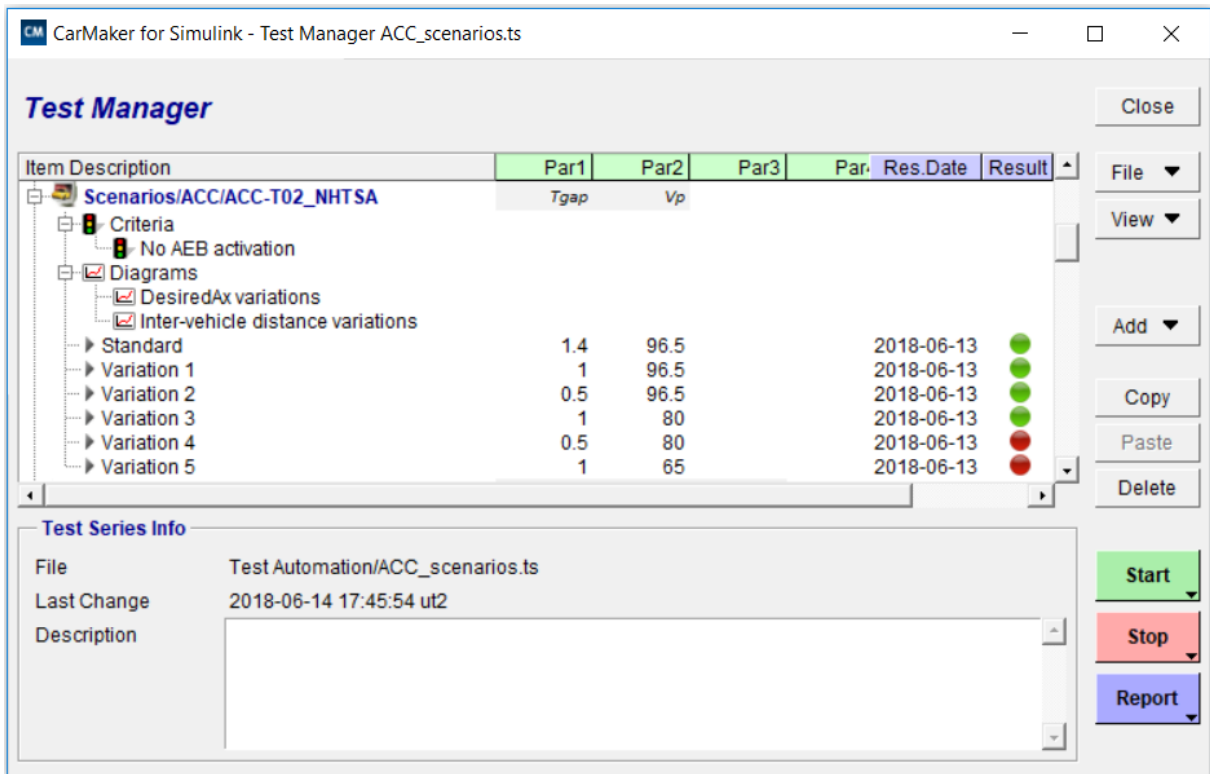

Figure 3.8: IPG CarMaker test manager window

CarMaker presents also some other tools to better analyze the results when the simulation is running or concluded. These include IPG Movie, which animates the TestRun to visually show the scenario perform, IPG control, in which it is possible to analyze variables behavior through graphs, and IPG instruments, which shows the actual dashboard of the car, with tachometer, rev counter, powertrain energy flow, fuel consumption, current gear number, driver's steering wheel movements and pedal actions, as well as the presence of active ADAS systems.

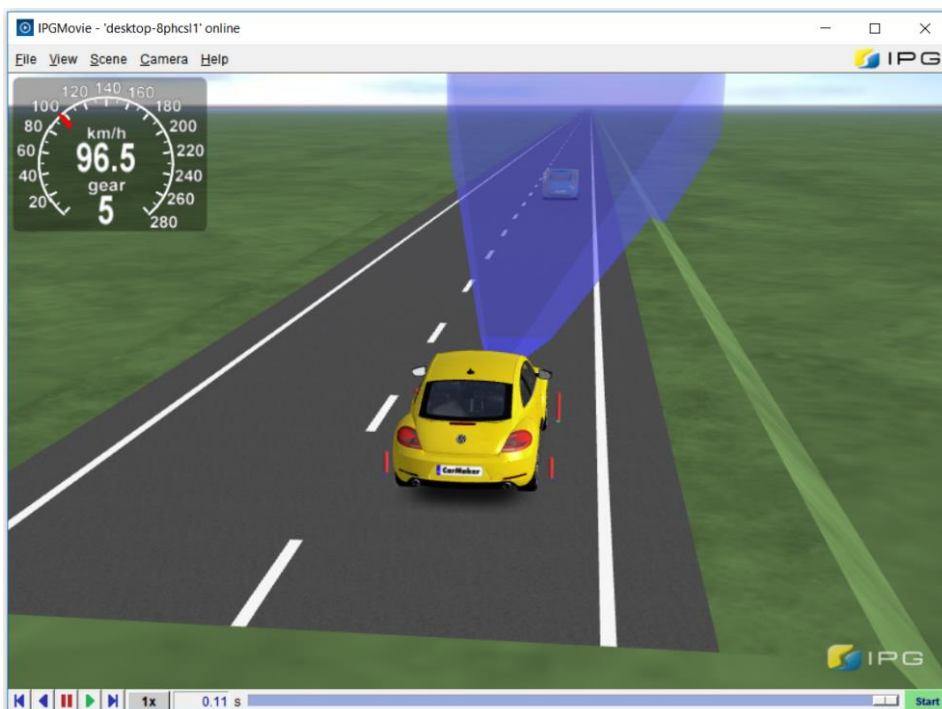

Figure 3.9: IPG Movie window

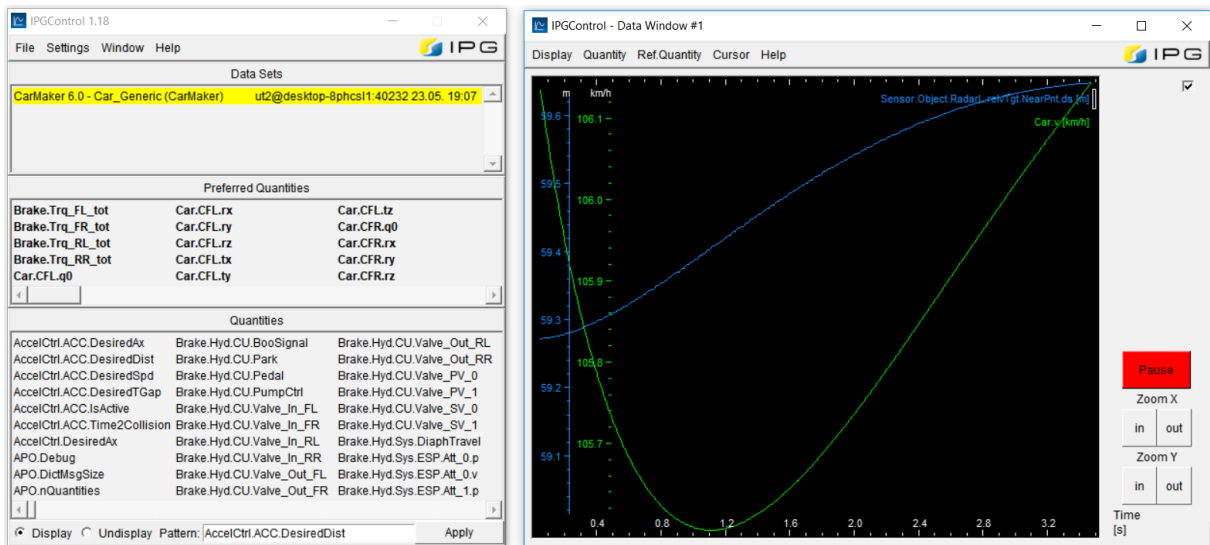

Figure 3.10: IPG Control window

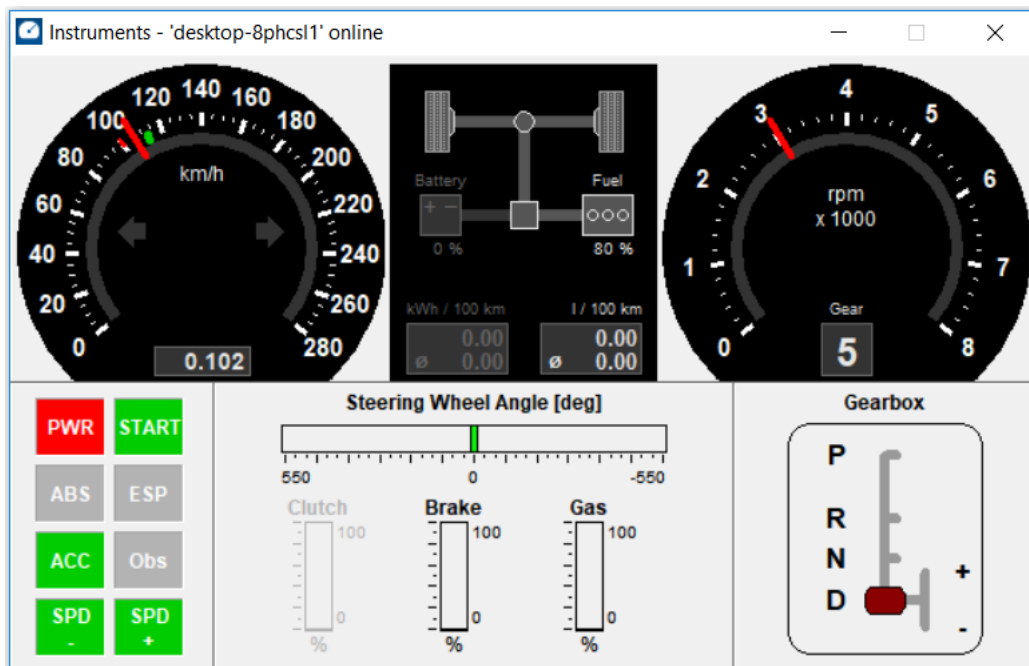

Figure 3.11: IPG Instruments window

3.2 ACC/AEB controller logic

The logic of the ACC and AEB was developed in Simulink thanks to the CarMaker extension. By opening the Simulink model, it is possible to see the main structure as shown in Figure 3.12.

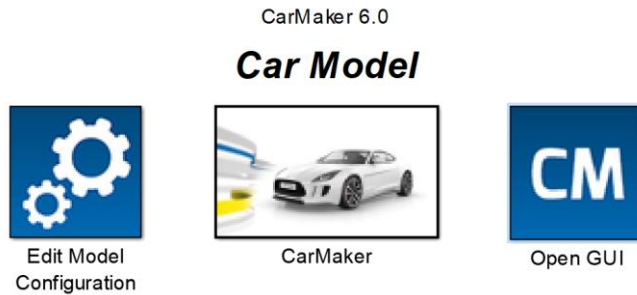

Figure 3.12: Simulink model main window

The first block is dedicated to additional options used only for advanced applications, the second block is the Simulink representation of CarMaker models, while the third one allows to access to the CarMaker GUI.

The CarMaker block represents the general structure of CarMaker in Simulink, consisting mainly of Driver/Driving Maneuver, Vehicle Control and Vehicle model.

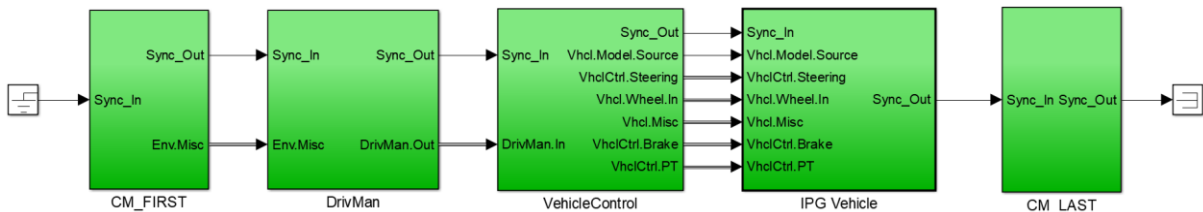

Figure 3.13: Simulink CarMaker model

The logic was implemented using the *VehicleControl* interface, instead of overcoming the driver's input by changing the signals in the *DrivMan* section, in order to keep driver's original intentions.

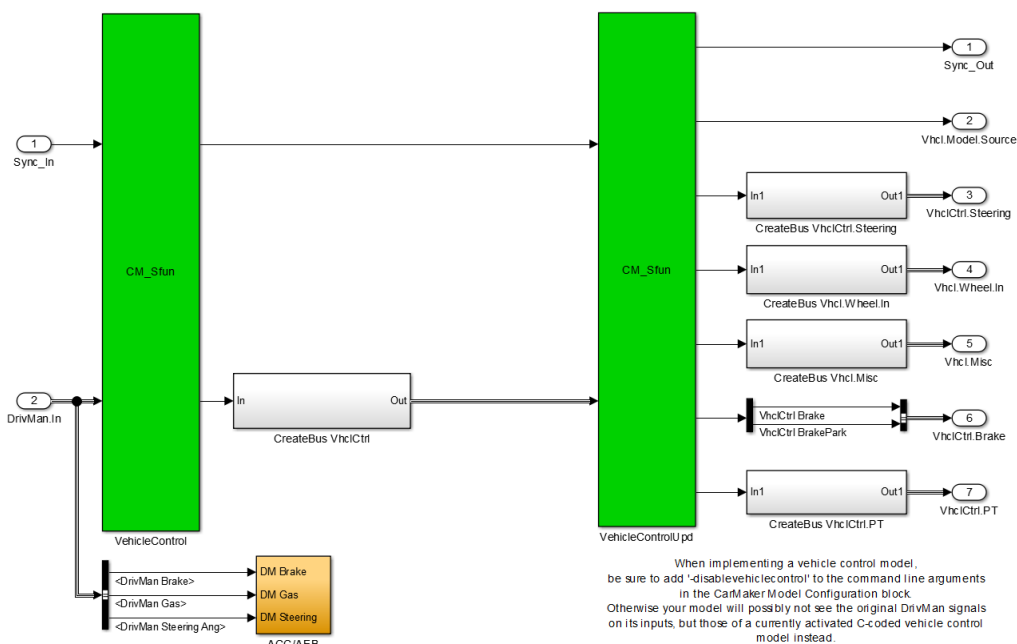

Figure 3.14: Simulink VehicleControl block

The main ACC/AEB blocks, as shown in Figure 3.15, are:

- **User Inputs:** contains the driver gas, brake and steering inputs, as well as his desired system values.
- **Sensor:** provides the sensor data.
- **ACC/AEB Control:** contains the actual controller logic.

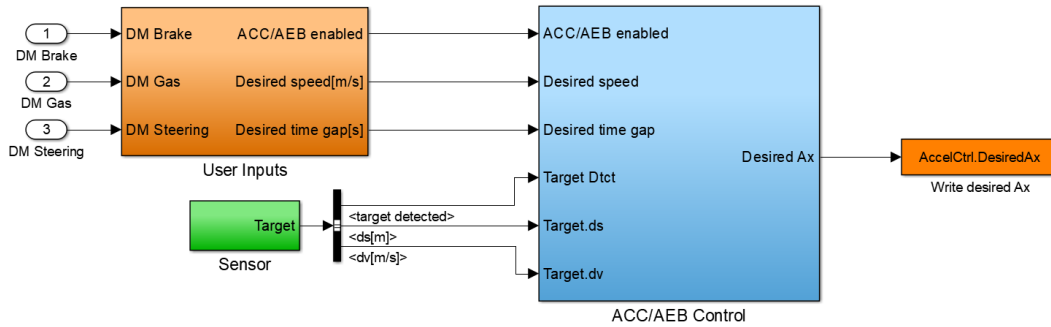

Figure 3.15: Simulink ACC/AEB block

As already described in Section 2.2, the system can be overridden if the driver brakes, accelerates or steers. For this reason, if at least one of these three DrivMan command exceeds its threshold, the system is deactivated. This structure is present in the “User Inputs” block, which outputs are the ACC/AEB status (enabled or not), the desired speed and the desired time gap. DVA variables are also defined in this block. The desired variables are created in the Simulink ambient with a “cm4sl” library block, called “Define CM Dict”, which generates a variable in the CarMaker dictionary. The “DVAwr” command, run in CarMaker maneuver box, writes the desired variable value to the CarMaker data dictionary and the same action can be performed in Simulink using the “Write CM Dict”. On the other hand, the variable is read from CarMaker dictionary through the “Read CM Dict” block, which provides its current value on the block’s output port. Once the desired Ax is calculated, the value is written in the “AccelCtrl.DesiredAx” block, and so provided to the CarMaker environment.

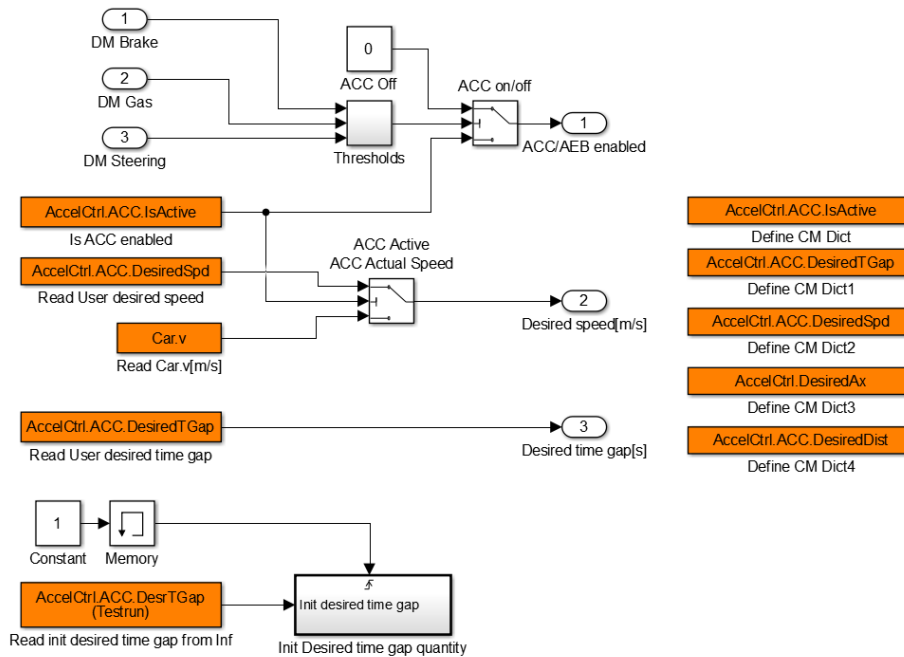

Figure 3.16: Simulink User Inputs block

The “Sensor” block is strictly connected to the object sensor “RadarL” created in CarMaker. The logic provides the relative distance (Target.ds) and the relative speed (Target.dv) between the target vehicle and host car, as well as if the target is detected. These quantities are also used to calculate the minimum distance reached between the host vehicle and the target vehicle during a TestRun, which value is utilized for the test automation criteria.

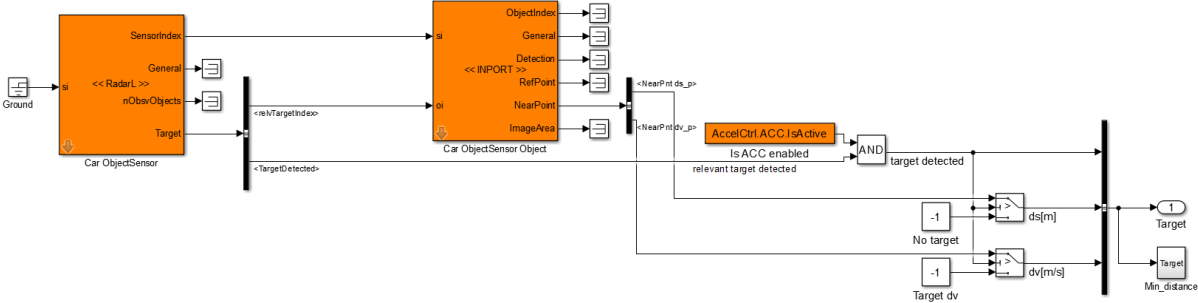

Figure 3.17: Simulink Sensor block

The ACC/AEB Control block contains the actual system logic, divided in “Desired Distance Computation” and “Control Algorithm”. The system provides an acceleration/deceleration only if the system is enabled, otherwise the output will be zero.

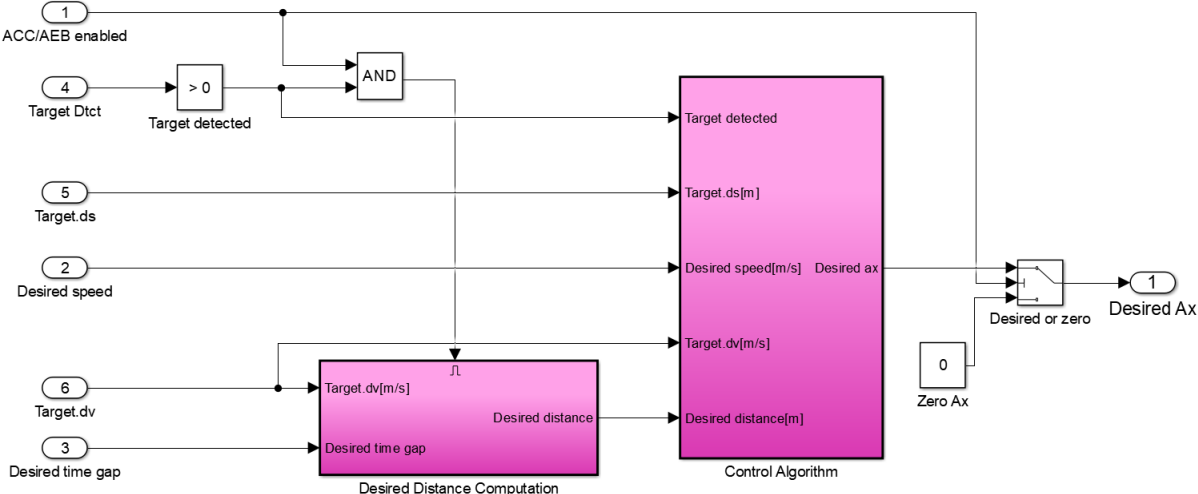

Figure 3.18: Simulink ACC/AEB control block

The first block, activated only if the system is enabled and the target is detected, calculates the safety distance based on the desired time gap, as shown in Figure 3.19.

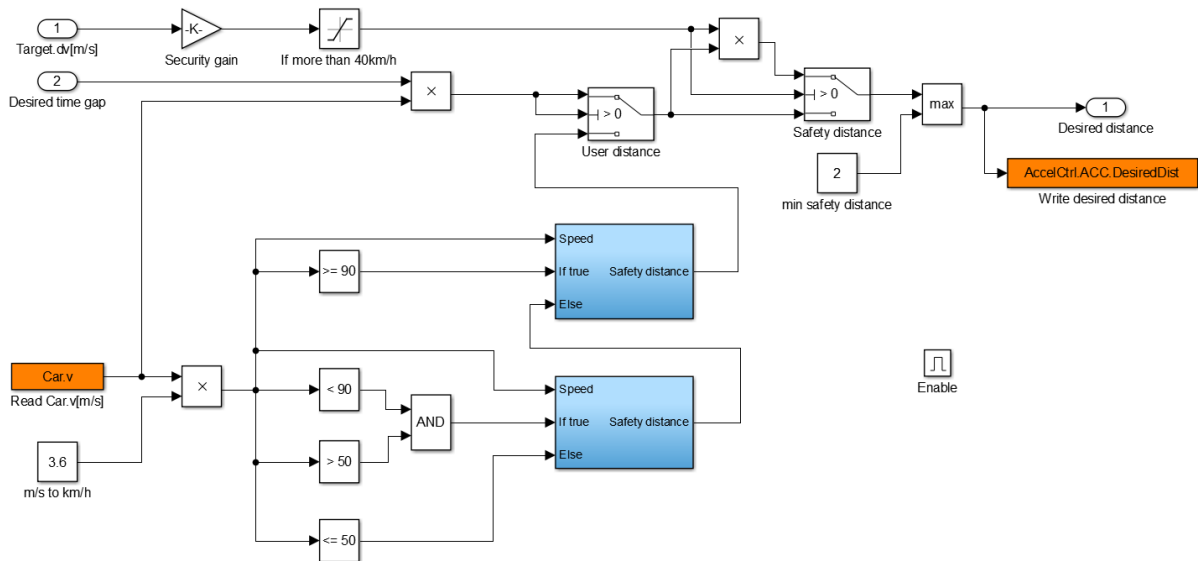

Figure 3.19: Simulink Desired Distance Computation block

However, if the user doesn't set a time gap, the safety distance is computed based on ACI (Italian Automobile Club) specifications, shown in Table 3.1 with the law associated depicted in Figure 3.20. Moreover, if the target vehicle is more than 40km/h slower than the host vehicle, a security gain is added proportionally to the desired distance. Finally, a minimum safety distance of 2m is established.

Host vehicle velocity (V) [Km/h]	Safety Distance (SD) [m]
50	25
90	40
130	130

Table 3.1: ACI security distance [35]

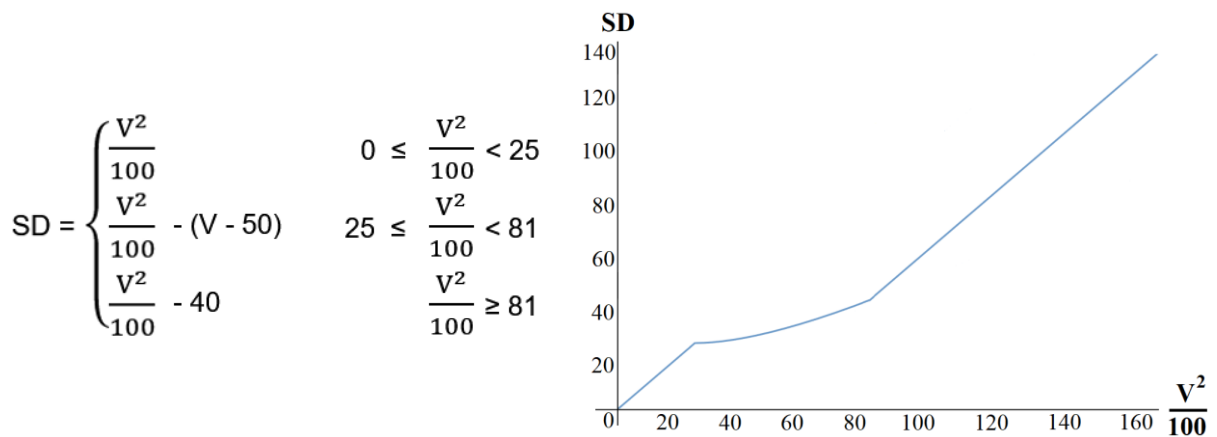

Figure 3.20: ACI security distance law and graphical trend

The “Control Algorithm” block contains the ACC and the AEB logic. The ACC controller distinguishes two cases:

1. If a target is detected, the desired distance and relative velocity will be controlled.
2. If there is no target detection, the desired host vehicle velocity will be controlled.

In both cases it was used a P controller with a proportional gain, and the resultant output is the desired acceleration/deceleration. A visual explanation is provided in Figure 3.21.

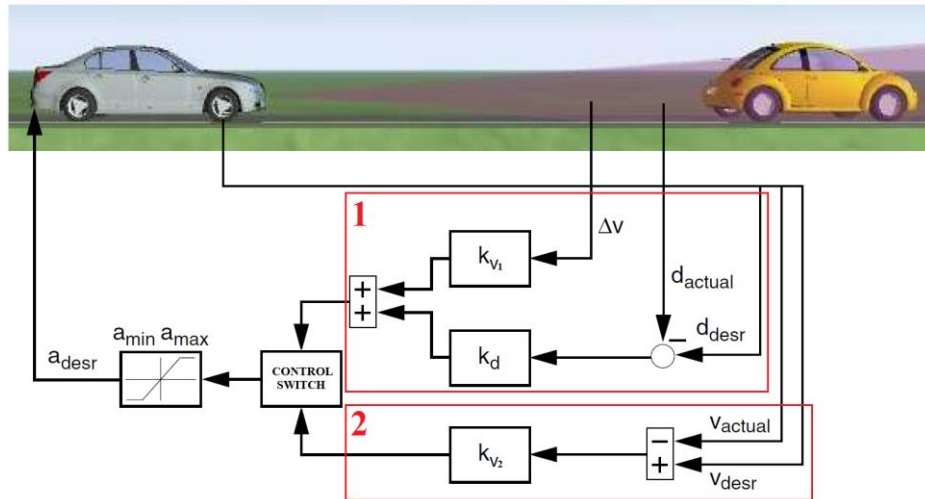

Figure 3.21: ACC control scheme [36]

The ACC block is separated into “Accelerate” and “Brake” actions, which have the same inputs (Target.ds, Target.dv, Desired distance and Desired speed), and which are then merged into one single acceleration/deceleration output.

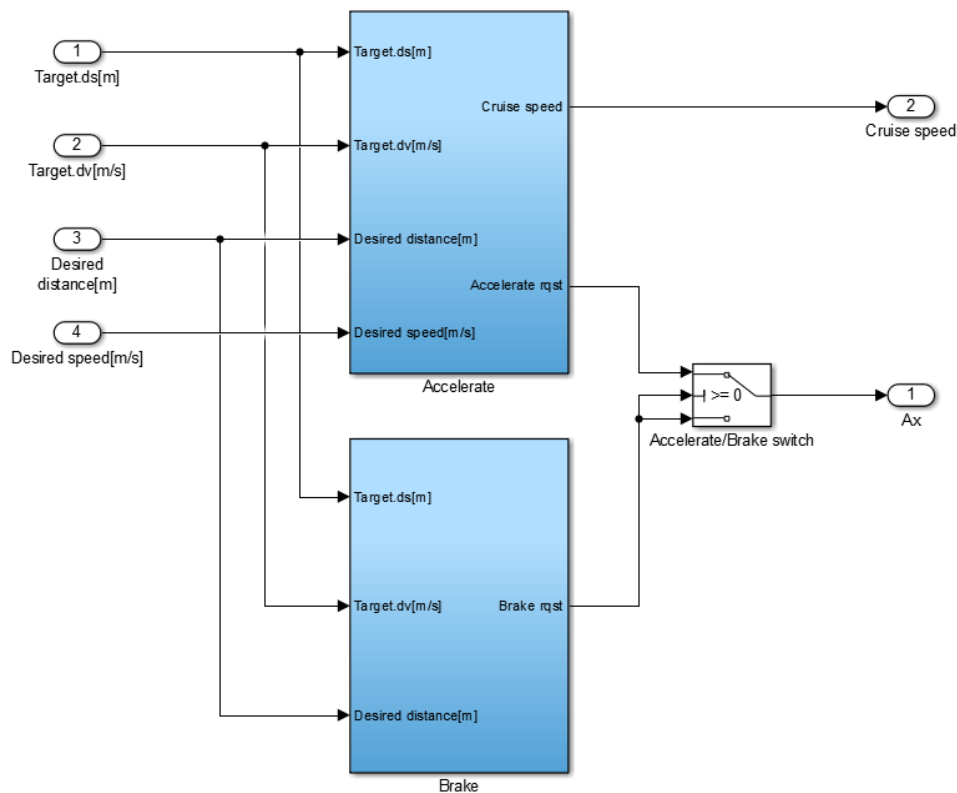

Figure 3.22: Simulink ACC control algorithm block

The switch condition between the “Accelerate” and the “Brake” block is present in the latter and is represented by the “Target.dv” value.

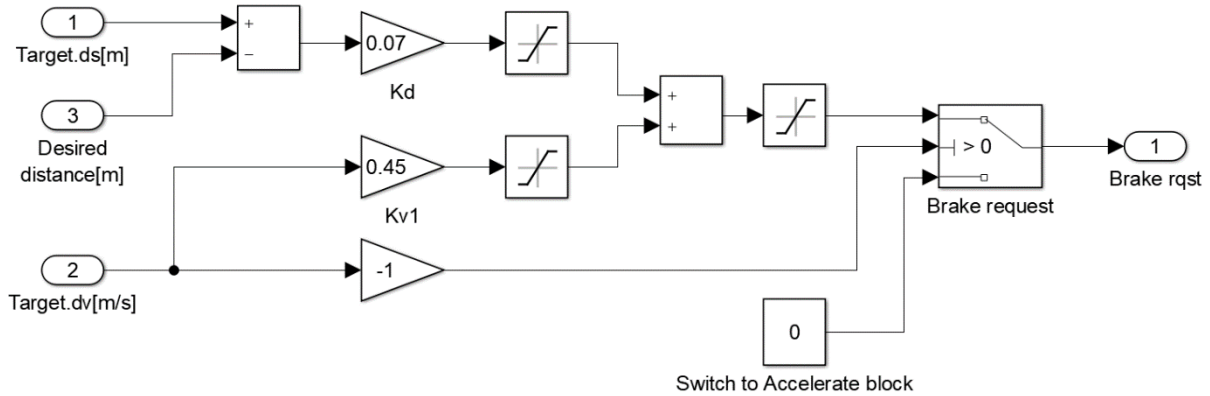

Figure 3.23: Simulink ACC Brake block

As previously reported, both the accelerate and the brake request are generated using a proportional relative distance and relative velocity controller. Therefore, the proposed gains $Kv1$ and Kd are associated respectively to the $Target.dv$ and to the difference between the $Target.ds$ and the desired distance. Moreover, in the “Accelerate” block, the computation of the desired cruise speed is executed, which cannot be exceeded in any case, with the gain $Kv2$. Additionally, if the target velocity is higher than the host vehicle velocity, but the $Target.ds$ is lower than the desired distance, the ACC will provide a deceleration with a P gain Kdd .

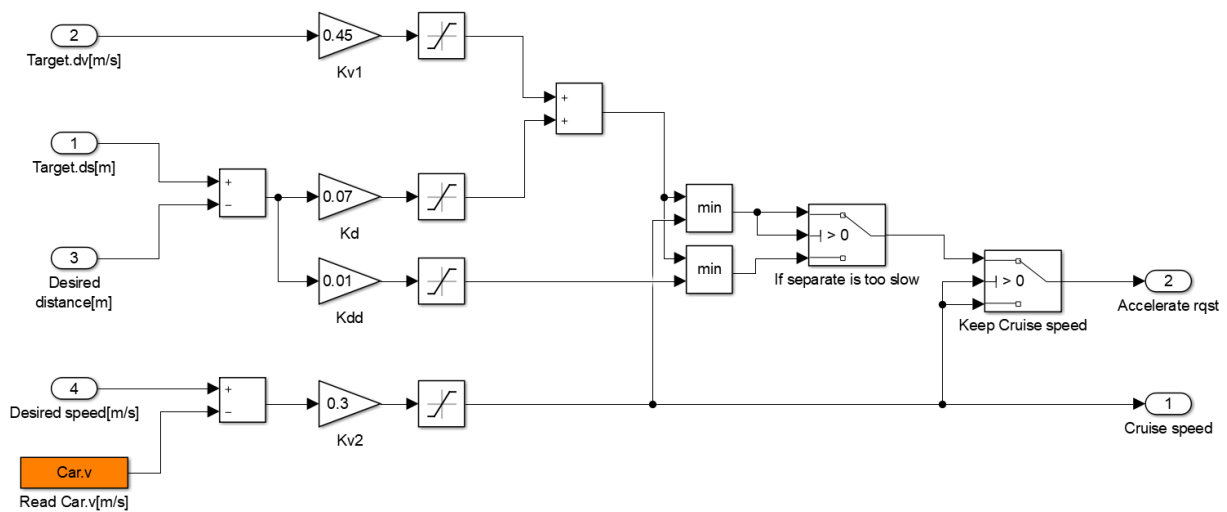

Figure 3.24: Simulink ACC Accelerate block

The distance and velocity controller change is determined by the switch on the right of Figure 3.25, so that, if the target is not detected, the ACC will work like a CC, accelerating until cruise speed is reached.

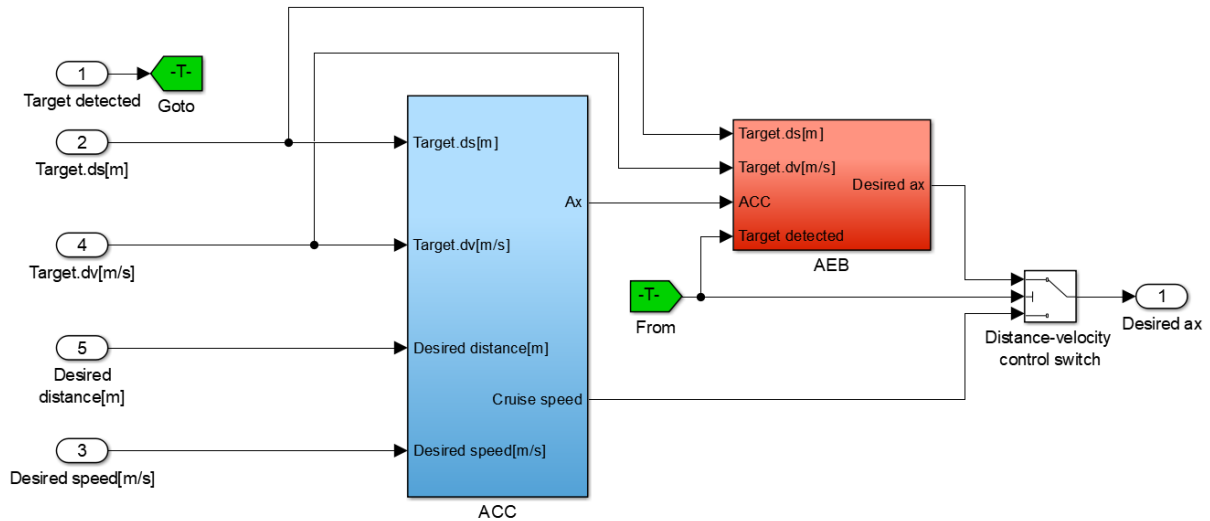

Figure 3.25: Simulink Control Algorithm block

The desired ACC a_x goes into the AEB block, which works as a switch.

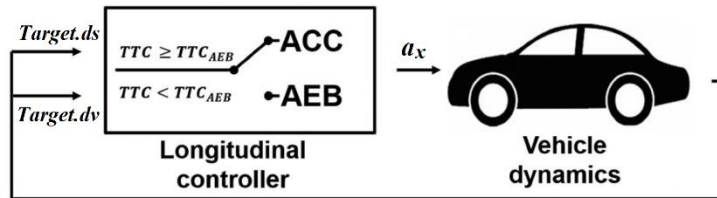

Figure 3.26: ACC/AEB switch scheme [37]

If the TTC goes under 2.4s and 1s, the pre-brake and the emergency brake of the AEB system are respectively activated, otherwise the desired a_x will be equal to the ACC a_x . The AEB inputs are also used to calculate the AEB status, both when is active and when it was, for the test automation criteria.

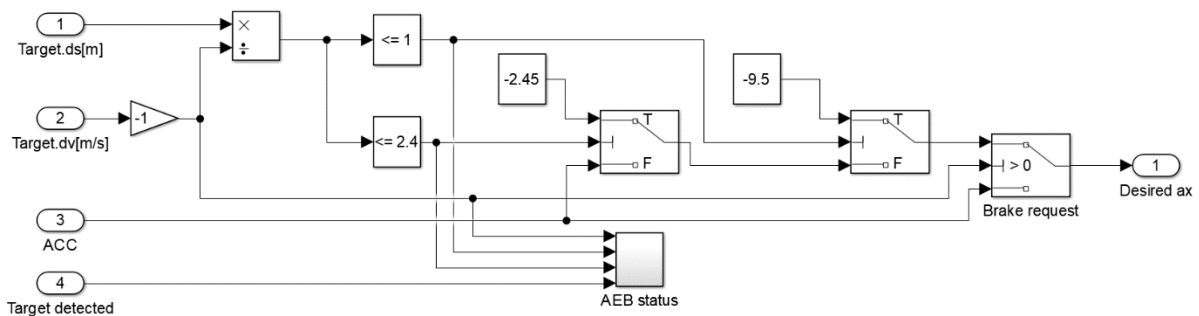

Figure 3.27: Simulink AEB control block

The P gains K_d , K_{dd} , K_{v1} and K_{v2} were chosen after several tuning attempts in order to reach a satisfying result. The gains, together with the acceleration/deceleration rates for the ACC and the AEB, are reported in Table 3.2.

SPECIFICATIONS	ACC	AEB	
Max deceleration [m/s ²]	-2.45	TTC ≤ 2.4s	-2.45
		TTC ≤ 1s	-9.5
Max acceleration [m/s ²]	1	not provided	
Kd	0.07		
Kdd	0.01		
Kv1	0.45		
Kv2	0.3		

Table 3.2: ACC and AEB specifications

The ACC values were implemented on the rates provided by NTHSA technical paper [38], ISO 15622 [20] and other studies [2], [9], [39], which define $A_{xMax} = 2 \text{ m/s}^2$ and $D_{xMax} = 3 \text{ m/s}^2$. The same was for the AEB values, which were chosen based on the rates provided by UNECE technical paper [40] and other studies [2], [37], [41], [42] which define emergency brake $D_{xMax} =$ from 3.3 m/s^2 to 10 m/s^2 with TTC between 0.5s and 1.5s, while pre-brake $D_{xMax} = 2.45 \text{ m/s}^2$ with TTC up to 1.6s before emergency brake deployment.

Chapter 4

Implementation: simulated scenarios

The driving scenarios presented in the following sections have been chosen to test ACC and AEB logic. Scenarios involving sensor testing (target recognition, acquisition or discrimination), like the ones present in the ISO 15622, 15623, SAE J2399 and SAE J2400, have been avoided because the sensor logic is provided by IPG CarMaker, which simulates an ideal radar.

The Chapter starts with Section 4.1, where the quantities used to describe the implemented scenarios are defined. The tests have been divided into ACC based and AEB based scenarios (Section 4.2 and 4.3 respectively), and a detailed description of each scenario is given. Moreover, the parametrized variables are reported, with a distinction between the actual scenario (Standard) and the modifications done (Variation) changing the quantities highlighted in blue. Finally, Section 4.4 reports the results, with detailed graphs of each test variation as well as their analysis.

4.1 Test quantities

The following quantities are used to analyse the implemented scenarios:

Quantity	Unit	Description
V	[Km/h]	Velocity of the host vehicle
V _{cruise}	[Km/h]	Desired cruise speed of the host vehicle
V _p	[Km/h]	Velocity of the preceding vehicle
A _p	[m/s ²]	Acceleration of the preceding vehicle
R	[m]	Range between the host vehicle and the preceding vehicle
T _{gap}	[s]	Desired time gap between the host vehicle and the preceding vehicle
R _d	[m]	Desired range between the host vehicle and the preceding vehicle obtained with $R_d = T_{gap} * V$
C _f	\	Road friction coefficient

Table 4.1: List of used quantities

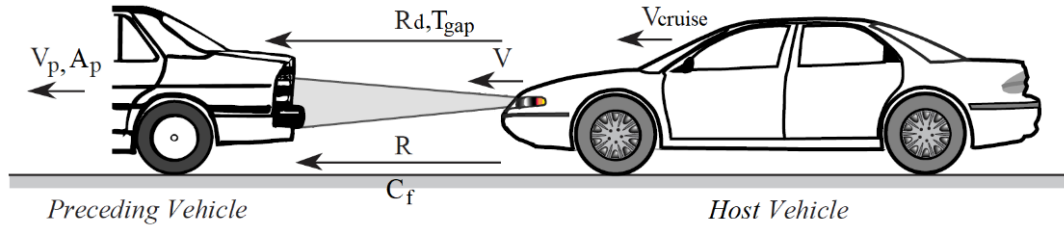

Figure 4.1: Quantities representation on vehicles [44]

4.2 ACC tested scenarios

As already stated in Section 2.5.2, currently there are no specific standards which regulate the ACC system, but in literature some proposed scenarios are presented. In particular were implemented the scenarios coming from the following institutions and authors: ISO [43], NHTSA (National Highway Traffic Safety Administration) [44], CTU (Czech Technical University) [43], Jinwei Zhou and Luigi del Re [45], plus a custom one.

4.2.1 ACC-T01: ISO 22178 - Vehicles in column: target vehicle cut-out

The test is defined by ISO 22178 document and is aimed at reacting to a new target vehicle. Three vehicles are traveling in column with minimum time gap between them, when the middle target vehicle decides to accelerate and then cuts-out. The host vehicle starts farther and must react to the new target vehicle when the middle one decides to leave the column. The test ends successfully when $V = V_{p2}$ and $R_2 = R_d$.

Note: R_2 and R_d changed due to T_{gap} modification.

Quantity	Standard	Variation 1	Variation 2	Variation 3	Variation 4	Variation 5
V	25	25	35	35	45	45
V_{cruise}	25	25	35	35	45	45
V_{p1}	25	25	35	35	45	45
V_{p2}	20	20	20	20	20	20
R_1	6.95	3.48	9.72	4.86	12.5	6.25
R_2	12.33	7.55	12.12	7.91	14.29	10.20
T_{gap}	1	0.5	1	0.5	1	0.5
R_d	5.56	2.78	5.56	2.78	5.56	2.78

Table 4.2: ACC-T01 test series

4.2.2 ACC-T02: NHTSA - Approaching a preceding vehicle

NHTSA implements three different scenarios in its “Intelligent Cruise Control Field Operational Test” technical report. In the first one a slower vehicle is detected, and so the host vehicle reduces its speed in order to match the velocity of the preceding vehicle and to reach the desired distance chosen by the selected time gap. The test ends successfully when $V = V_p$ and $R = R_d$.

Note: R_d changed due to T_{gap} modification.

Quantity	Standard	Variation 1	Variation 2	Variation 3	Variation 4	Variation 5
V	112.7	112.7	112.7	112.7	112.7	112.7
V _{cruise}	112.7	112.7	112.7	112.7	112.7	112.7
V _p	96.5	96.5	96.5	80	80	65
R	116	116	116	116	116	116
T _{gap}	1.4	1	0.5	1	0.5	1
R _d	37.5	26.8	13.4	22.2	11.1	18

Table 4.3: ACC-T02 test series

4.2.3 ACC-T03: NHTSA - Changing to a new headway

The purpose of the second NHTSA scenario is to see how the VUT responds when the time gap is modified. NHTSA proposes three variations, using time gap of 1, 1.4, and 2 seconds. Once start conditions are reached, the host vehicle must reduce or increase the distance from the preceding vehicle when respectively time gap is decreased or risen. The test ends successfully when $V = V_p$ and $R = R_d$.

Note: R_d changed due to T_{gap} modification.

Quantity	Standard 1	Standard 2	Standard 3	Standard 4	Variation 1	Variation 2
V	106.2	106.2	106.2	106.2	106.2	106.2
V _{cruise}	112.7	112.7	112.7	112.7	112.7	112.7
V _p	106.2	106.2	106.2	106.2	106.2	106.2
R	59	29.5	59	41.3	59	14.75
T _{gap}	2->1	1->2	2->1.4	1.4->2	2->0.5	0.5->2
R _d	29.5	59	41.3	59	14.75	59

Table 4.4: ACC-T03 test series

4.2.4 ACC-T04: NHTSA - Manually accelerating and near encounter

The aim of the last NHTSA test is to verify the gas pedal override capability as well as to evaluate the system response to a near target vehicle encounter. The driver of the host vehicle accelerates until the range gets to approximately 2/3 of the original distance, then he releases the gas pedal. The ACC system must stay off until there is a driver input, and only then the host vehicle should react to the target vehicle decreasing its velocity until the proper distance condition is reached. The test ends successfully when $V = V_p$ and $R = R_d$.

Note: R_d changed due to T_{gap} modification.

Quantity	Standard	Variation 1	Variation 2	Variation 3	Variation 4	Variation 5
V	96.5	96.5	96.5	96.5	96.5	96.5
V _{cruise}	112.7	112.7	112.7	112.7	112.7	112.7
V _p	96.5	96.5	96.5	96.5	96.5	96.5
R	25	25	25	20	15	10
T _{gap}	1.4	1	2	1.4	1.4	1.4
R _d	37.5	26.8	53.6	37.5	37.5	37.5

Table 4.5: ACC-T04 test series

4.2.5 ACC-T05: CTU-F – Lane change vehicle interaction

This test, selected from Czech Technical University, is focused on evaluating the promptness of the ACC system in case of the presence of a target vehicle after performing a lane change. The host vehicle is running on its lane maintaining a constant speed of 80 km/h, and the same the target vehicle in the adjacent lane. After the distance between the two vehicles is between 15 m and 20 m, the ACC vehicle moves to the target lane. The host vehicle must decelerate according to the desired distance to maintain from the detected vehicle. The test ends successfully when $V = V_p$ and $R = R_d$.

Note: R_d changed due to T_{gap} modification.

Quantity	Standard	Variation 1	Variation 2	Variation 3	Variation 4	Variation 5
V	80	80	95	95	110	110
V _{cruise}	80	80	95	95	95	95
V _p	80	80	80	80	80	80
R	16.5	16.5	16.5	16.5	16.5	16.5
T _{gap}	1	2	1	2	1	2
R _d	22.2	44.4	22.2	44.4	22.2	44.4

Table 4.6: ACC-T05 test series

4.2.6 ACC-T06: Zhou paper – Vehicles in column: target vehicle cut-in

This test is part of Jinwei Zhou and Luigi del Re scenarios set up for their research focused on the ADAS testing. The host vehicle is following a preceding vehicle, when suddenly a third car from the adjacent lane cuts in between the two vehicles with a constant angle and a slower but constant velocity. The ACC must react to the new target which suddenly appears closer than the previous one. The test ends successfully when $V = V_{p2}$ and $R_2 = R_d$.

Note: R_2 was changed modifying target vehicle 1 cut in time and R_d changed due to V_{p2} modification.

Quantity	Standard	Variation 1	Variation 2	Variation 3	Variation 4	Variation 5
V	108	108	108	108	108	108
V _{cruise}	108	108	108	108	108	108
V _{p1}	108	108	108	108	108	108
V _{p2}	84	82	86	84	86	88
R ₁	45	45	45	45	45	45
R ₂	14.9	10.1	20.7	9.6	14.1	21.5
T _{gap}	1.5	1.5	1.5	1.5	1.5	1.5
R _d	35	34.2	35.8	35	35.8	36.7

Table 4.7: ACC-T06 test series

4.2.7 ACC-T07: Custom – Lane change and cruise speed test

The last ACC scenario implemented is a custom test which analyzes other possible hazard situations. The host car is following the target vehicle, when the VUT driver decides to change lane. In the adjacent lane a slower vehicle is present, which, after some seconds, accelerates until it exceeds the host vehicle cruise speed. In the first part of this test, similar to the ACC-T05 scenario, the host vehicle must react to a slower vehicle encounter after a lane change reducing its speed and maintaining the correct vehicle gap, while in the second part it is evaluated the capability of the system to not overcome the cruise speed, even if the target distance is higher than the desired one. In this scenario the T_{gap} is not used, meaning that the security distance is provided by ACI algorithm. The test ends successfully when V = V_{cruise}. Note: R₂ was changed modifying host vehicle cut in time.

Quantity	Standard	Variation 1	Variation 2	Variation 3	Variation 4	Variation 5
V	80	80	80	80	80	80
V _{cruise}	90	90	90	90	90	90
V _{p1}	80	80	80	80	80	80
V _{p2}	50->120	50->120	50->120	45->120	45->120	45->120
R ₁	34	34	34	34	34	34
R ₂	38.3	30.2	21.9	28.9	18.8	9.3
T _{gap}	\	\	\	\	\	\
R _d	104	104	104	104	104	104

Table 4.8: ACC-T07 test series

4.3 AEB tested scenarios

For what concern the AEB system, several institutions and authors provide their own testing scenarios, being this ADAS on the road of approval for light-duty car. The more relevant scenarios which was selected are from: EuroNCAP [32], European Commission [46], ISO [47], CTU [43] and Wei-Jen Wang [48].

4.3.1 AEB-T01: EuroNCAP CCRs – Approaching a stationary vehicle

EuroNCAP presents three different scenarios in its AEB test protocol. In the first one the host car approaches a stopped vehicle. For AEB city systems are established test speeds from 10 to 50 km/h while for inter-urban systems from 30 to 80 km/h. EuroNCAP gives a rate based on stars (which maximum is five) depending on the test results, i.e. if the host vehicle does not collide with the target vehicle or reduces the impact speed.

Quantity	Standard 1		Standard 2		Standard 3		Standard 4		Standard 5		Standard 6	
V	30		40		50		60		70		80	
V _p	0		0		0		0		0		0	
R	200		200		200		200		200		200	
C _f	1	0.5	1	0.5	1	0.5	1	0.5	1	0.5	1	0.5

Table 4.9: AEB-T01 test series

4.3.2 AEB-T02: EuroNCAP CCR_m – Approaching a slower moving vehicle

The second EuroNCAP scenario is for AEB inter-urban systems only. The test describes the approaching to a slower moving vehicle. The VUT is tested with speed range 30-80 km/h, while the target vehicle is at 20 km/h.

Quantity	Standard 1		Standard 2		Standard 3		Standard 4		Standard 5		Standard 6	
V	30		40		50		60		70		80	
V _p	20		20		20		20		20		20	
R	200		200		200		200		200		200	
C _f	1	0.5	1	0.5	1	0.5	1	0.5	1	0.5	1	0.5

Table 4.10: AEB-T02 test series

4.3.3 AEB-T03: EuroNCAP CCR_b – Following a decelerating vehicle

As the previous scenario, the third EuroNCAP test is performed only for AEB inter-urban systems. The host vehicle is following the preceding vehicle when suddenly the latter decides to brake. The test considers two headway conditions (short 12 m and long 40 m) and two braking levels (normal 2 m/s² and emergency 6 m/s²) for the target car.

Quantity	Standard 1		Standard 2		Standard 3		Standard 4	
V	50		50		50		50	
V _p	50->0		50->0		50->0		50->0	
A _p	-2		-2		-6		-6	
R	40		12		40		12	
C _f	1	0.5	1	0.5	1	0.5	1	0.5

Table 4.11: AEB-T03 test series

4.3.4 AEB-T04: EU 347/2012 – Approaching a slower moving vehicle

European Union Regulation No. 347/2012 describes five scenarios defining the characteristics of the AEB system for trucks and buses. The tests are divided in: warning and activation test with a stationary target, warning and activation test with a moving target, failure detection test, deactivation test, false reaction test. The last three tests were not implemented because not relevant for the logic testing. The first one was neither performed because it is identical to the AEB-T01: EuroNCAP CCRs scenario, with the host vehicle travelling at 80 km/h against a stationary target and the test pass condition of host vehicle total speed reduction, at the time of the impact, not less than 10 km/h for Approval 1 and not less than 20 km/h for Approval 2 (for more information see Appendix). The second EU test is similar to the AEB-T02: EuroNCAP CCRm scenario, with the host vehicle travelling against a slower moving target, but the conditions are slightly different.

According to the document, the VUT shall approach the stationary target for at least two seconds before the activation of the AEB and the test starts when the host vehicle is travelling at 80 ± 2 km/h and is at least 120m from the target.

Moreover, any speed reduction during the warning phase shall not exceed either 15 km/h or 30 % of the total subject vehicle speed reduction, whichever is higher, and the emergency braking phase shall not start before a TTC equal to or less than 3 seconds.

In order to pass the test, the host vehicle shall not impact with the moving target. For Approval 1 the target speed is 32 ± 2 km/h, while for Approval 2 is 12 ± 2 km/h.

Quantity	Standard 1		Standard 2		Variation 1		Variation 2		Variation 3	
V	80		80		80		80		80	
V _p	30		10		40		20		5	
R	140		140		140		140		140	
C _f	1	0.5	1	0.5	1	0.5	1	0.5	1	0.5

Table 4.12: AEB-T04 test series

4.3.5 AEB-T05: ISO 22179 – Following a decelerating vehicle

The test is based on the ISO 22179 and it is similar to the AEB-T02: EuroNCAP CCRb scenario, with the host vehicle travelling against a braking target. The ISO document states that the host car should stop in presence of a target vehicle travelling at least at 36km/h and which decelerates with 2.5 m/s^2 .

Note: R was changed in order to maintain the same T_{gap} .

Quantity	Standard		Variation 1		Variation 2		Variation 3	
V	40		45		50		55	
V _p	40		45		50		55	
A _p	-2.5		-2.5		-2.5		-2.5	
R	22.2		25		27.8		30.5	
C _f	1	0.5	1	0.5	1	0.5	1	0.5

Table 4.13: AEB-T05 test series

4.3.6 AEB-T06: CTU-C – Static target encounter after vehicle cut-out

This test, selected from Czech Technical University, is focused on evaluating the promptness of the AEB system in case of an unexpected static target. The host vehicle is following the preceding vehicle, when suddenly the latter changes lane to avoid a stationary car. The AEB system, therefore, must react to mitigate the collision with the unexpected static target. The test ends successfully if the host vehicle reacts to the static target starting to brake, and so reducing the impact speed even if the target is very close.

Note: R1 was changed in order to maintain the same T_{gap}.

Quantity	Standard		Variation 1		Variation 2		Variation 3		Variation 4	
V	70		60		50		45		40	
V _{p1}	70		60		50		45		40	
V _{p2}	0		0		0		0		0	
R1	19.5		16.7		13.9		12.5		11.1	
R2	26		26		26		26		26	
C _f	1	0.5	1	0.5	1	0.5	1	0.5	1	0.5

Table 4.14: AEB-T06 test series

4.3.7 AEB-T07: Wang paper – Vehicles in column: target vehicle cut-in

This test is part of Wang scenarios shown during the ITS world congress of 2017. The host vehicle is following a preceding vehicle, when suddenly a third car from the adjacent lane cuts in between the two vehicles with a slower speed and then accelerates. The situation defined by Wang could also be seen as the attempt of a highway access through the acceleration lane. In case of emergency conditions, the AEB must react, avoiding or mitigating a collision.

Quantity	Standard		Variation 1		Variation 2		Variation 3	
V	108		108		108		108	
V _{p1}	108		108		108		108	
V _{p2}	54->72		65->72		60->72		45->72	
A _{p2}	1.11		1.11		1.11		1.11	
R1	30		30		30		30	
R2	25.5		25.5		25.5		25.5	
C _f	1	0.5	1	0.5	1	0.5	1	0.5

Table 4.15: AEB-T07 test series

4.4 Results

As for the previous Section, the results have been divided into ACC based and AEB based scenarios, and a detailed graph of each test variation is given.

The quantities presented in each diagram are:

Quantity	Unit	Description
AccelCtrl.ACC.DesiredDist	[m]	Desired distance between the host vehicle and the preceding vehicle
AccelCtrl.ACC.DesiredSpd	[Km/h]	Desired cruise speed of the host vehicle
AccelCtrl.ACC.DesiredTGap	[s]	Desired time gap between the host vehicle and the preceding vehicle
AccelCtrl.DesiredAx	[m/s ²]	Desired acceleration of the host vehicle
AccelCtrl.TargetDist	[m]	Distance between the host vehicle and the preceding vehicle
AccelCtrl.TargetSpd	[Km/h]	Velocity of the preceding vehicle
Car.v	[Km/h]	Velocity of the host vehicle
AccelCtrl.AEB.IsActive	\	AEB activation status (boolean)

Table 4.16: List of used quantities in the results graphs

4.4.1 ACC

The criteria used for evaluating the ACC scenarios is the following:

- If AEB doesn't activate during the test execution, it is considered a pass (green mark).
- If AEB activates during the test execution, it is considered a fail (red mark).

The overall results chart is presented in Figure 4.2, where the total number of passed and failed test, as well as their percentage, is reported. All the ACC test series scenarios were created into a single file called "ACC_scenarios.ts" with a total simulation time at full speed of 4min 56s.

Overall Results

Number of Tests:	42	100.0 %	
Tests passed:	27	64.3 %	✓
Tests skipped:	0	0.0 %	⬇
Tests with warning:	0	0.0 %	⚠
Tests failed:	15	35.7 %	✗
Tests with error:	0	0.0 %	⚡
Tests not executed:	0	0.0 %	○

Figure 4.2: ACC scenarios overall results chart

4.4.1.1 ACC-T01: ISO 22178 - Vehicles in column: target vehicle cut-out

The goal of the test is to verify ACC action when, being on a queue, the preceding vehicle cuts out revealing another target vehicle. In Figure 4.3 is shown the detailed result chart presented in the CarMaker test manager report, while in the following graphs the quantities trends for each case are reported.

Detailed Results

ID	Test	Result
1	Scenarios/ACC/ACC-T01_ISO_22178	
1.1	Standard	✓
1.2	Variation 1	✓
1.3	Variation 2	✓
1.4	Variation 3	⚡
1.5	Variation 4	⚡
1.6	Variation 5	⚡

Figure 4.3: ACC-T01 test series detailed results

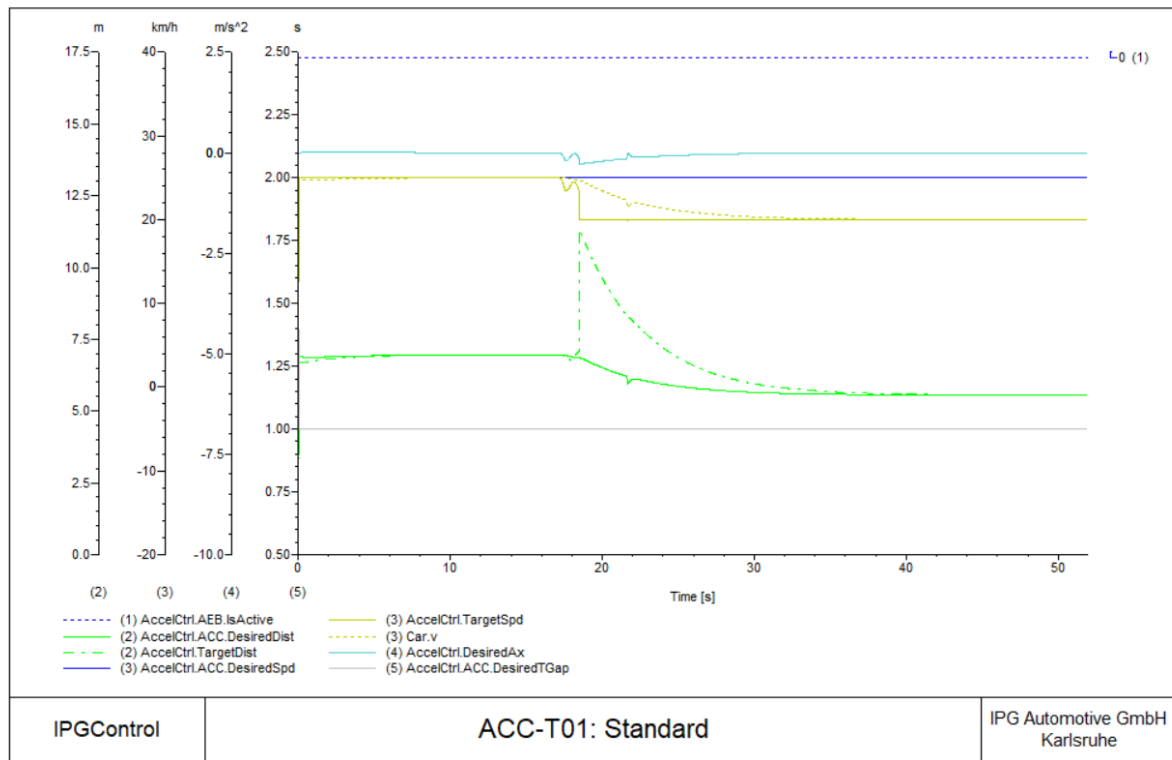
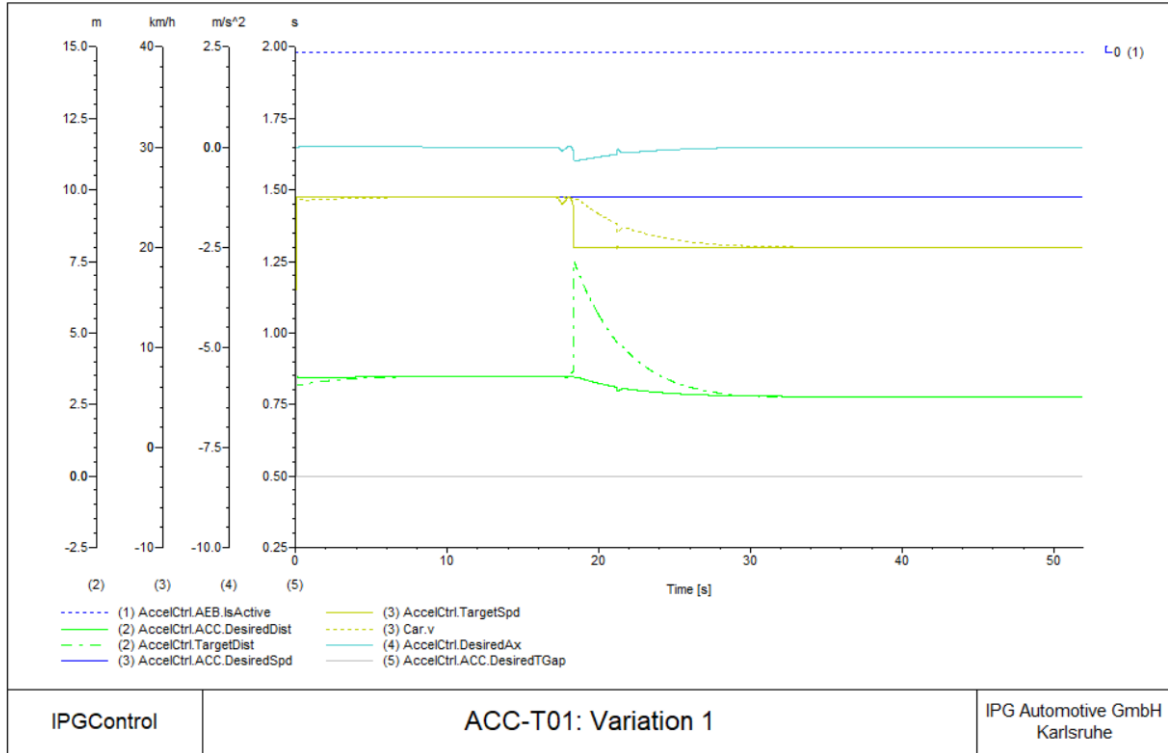
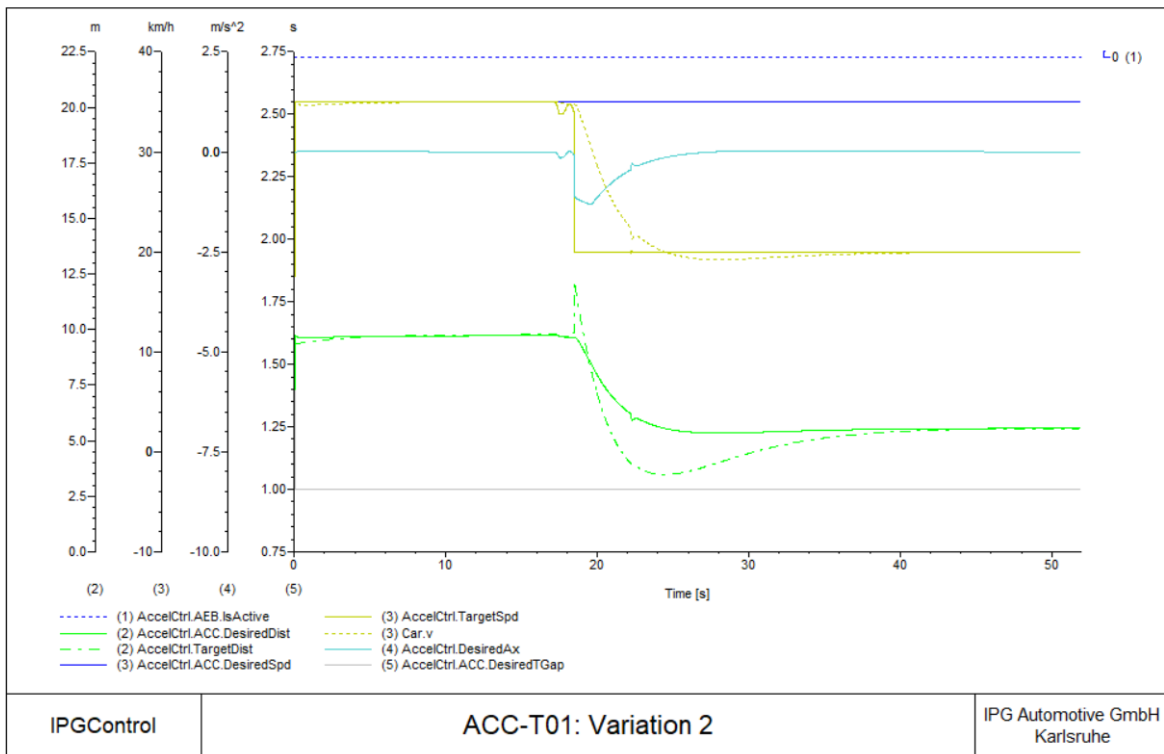

Figure 4.4: ACC-T01 Standard result graph



12.06.18 - 13:22

Figure 4.5: ACC-T01 Variation 1 result graph



12.06.18 - 13:24

Figure 4.6: ACC-T01 Variation 2 result graph

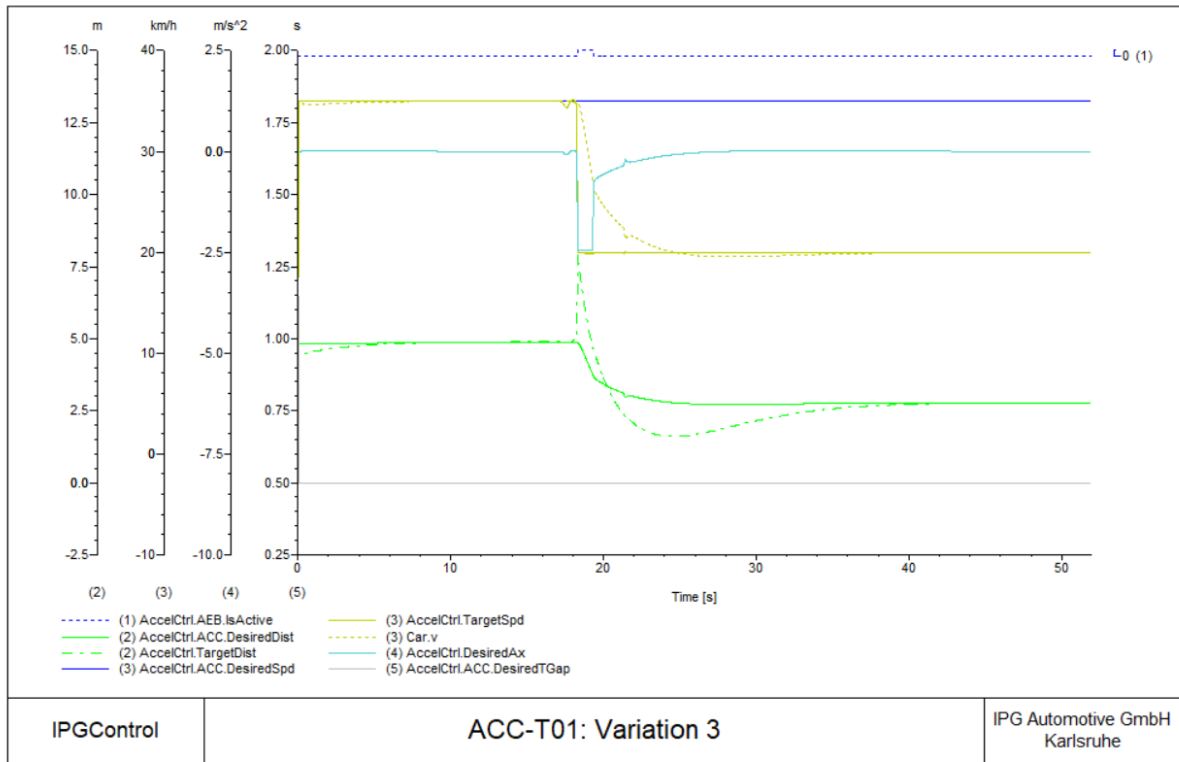

12.06.18 - 13:11

Figure 4.7: ACC-T01 Variation 3 result graph

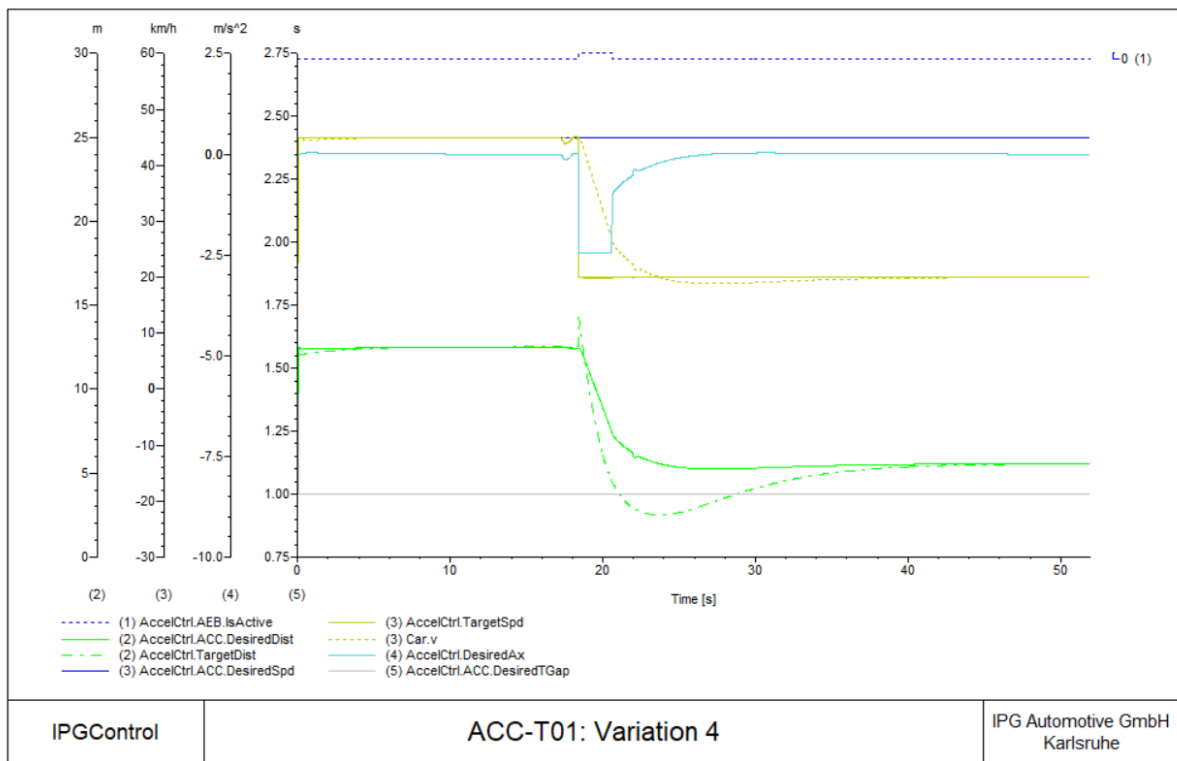

12.06.18 - 13:13

Figure 4.8: ACC-T01 Variation 4 result graph

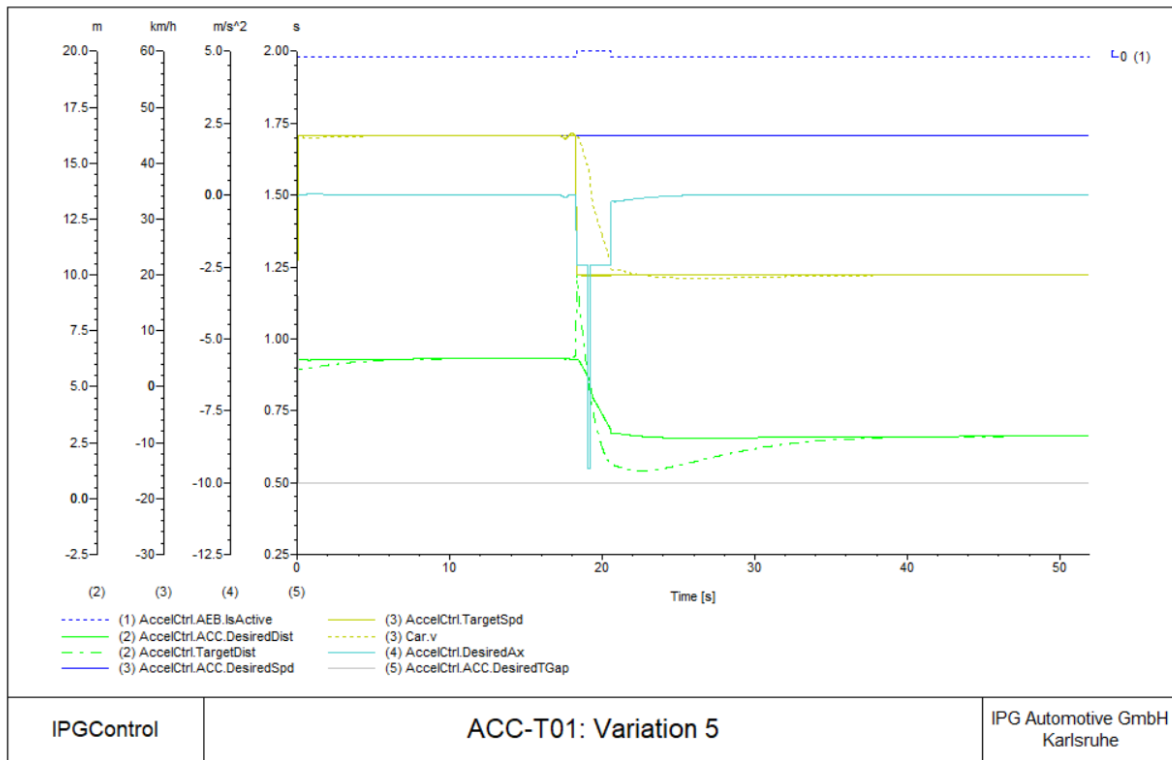

12.06.18 - 13:16

Figure 4.9: ACC-T01 Variation 5 result graph

As it is possible to see, decreasing or increasing too much the time gap or the host vehicle velocity respectively, will produce a higher deceleration request (displayed as a solid light blue line), until the AEB activation (displayed as a dotted blue line), leading to a test fail. In Standard, Variation 1 and 2 the ACC was still capable of managing the situation. In Variation 3 and 4 the AEB pre-brake system activated, while in Variation 5 the full brake force was necessary in order to avoid a collision. In all cases it is possible to see how the inter-vehicle distance and host car velocity (green and yellow dotted line respectively) tend to reach and follow the desired distance and the target vehicle velocity (green and yellow solid line respectively). The desired speed, displayed with a solid blue line, has a higher value, and so the logic is performing a distance control action. To better understand the difference between the various variations, AccelCtrl.DesiredAx and AccelCtrl.TargetDist quantities are reported in Figure 4.10 and Figure 4.11, showing their trend during each test case. The two graphs reproduce the behavior of the previous diagrams, showing that decreasing the time gap, the distance between the two vehicle reduces, while when increasing the host vehicle velocity, the initial intervehicle distance increases to maintain the same time gap, but the minimum distance between the two vehicles, after the second car leaves the column, is smaller, with a higher deceleration request.

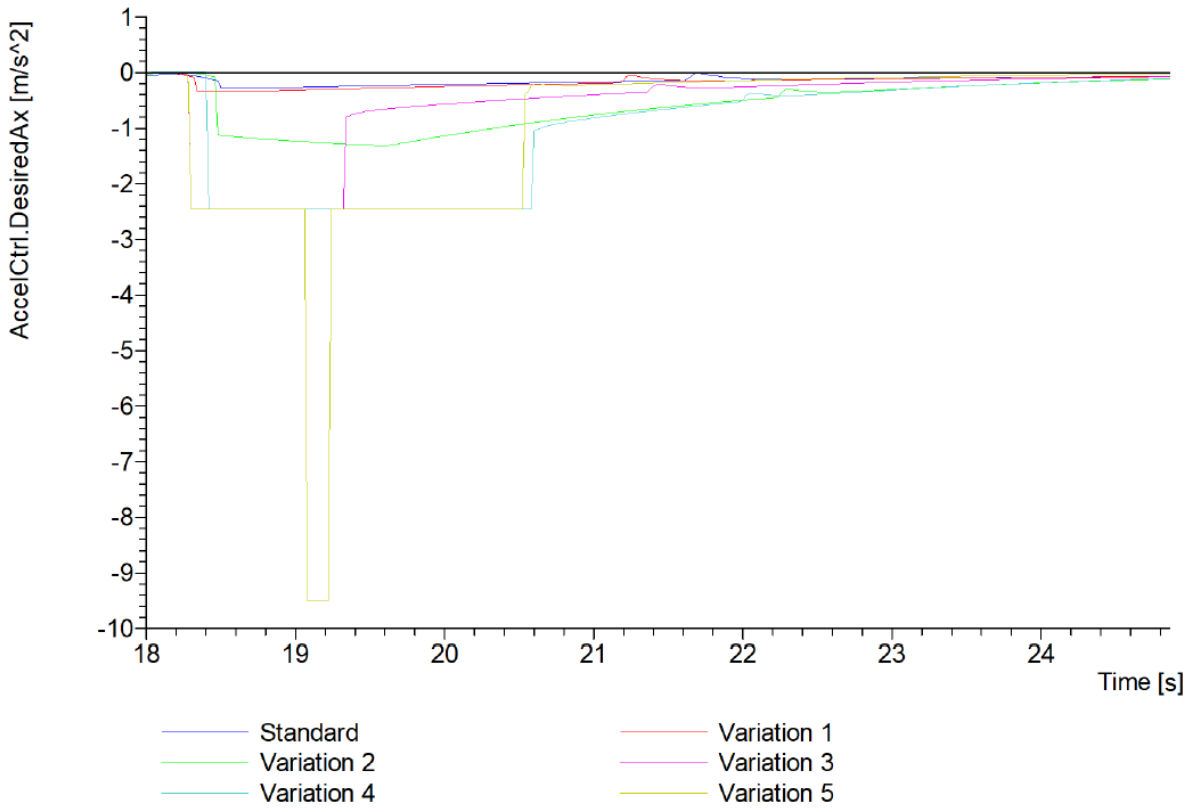

Figure 4.10: ACC-T01 AccelCtrl.DesiredAx variations result graph

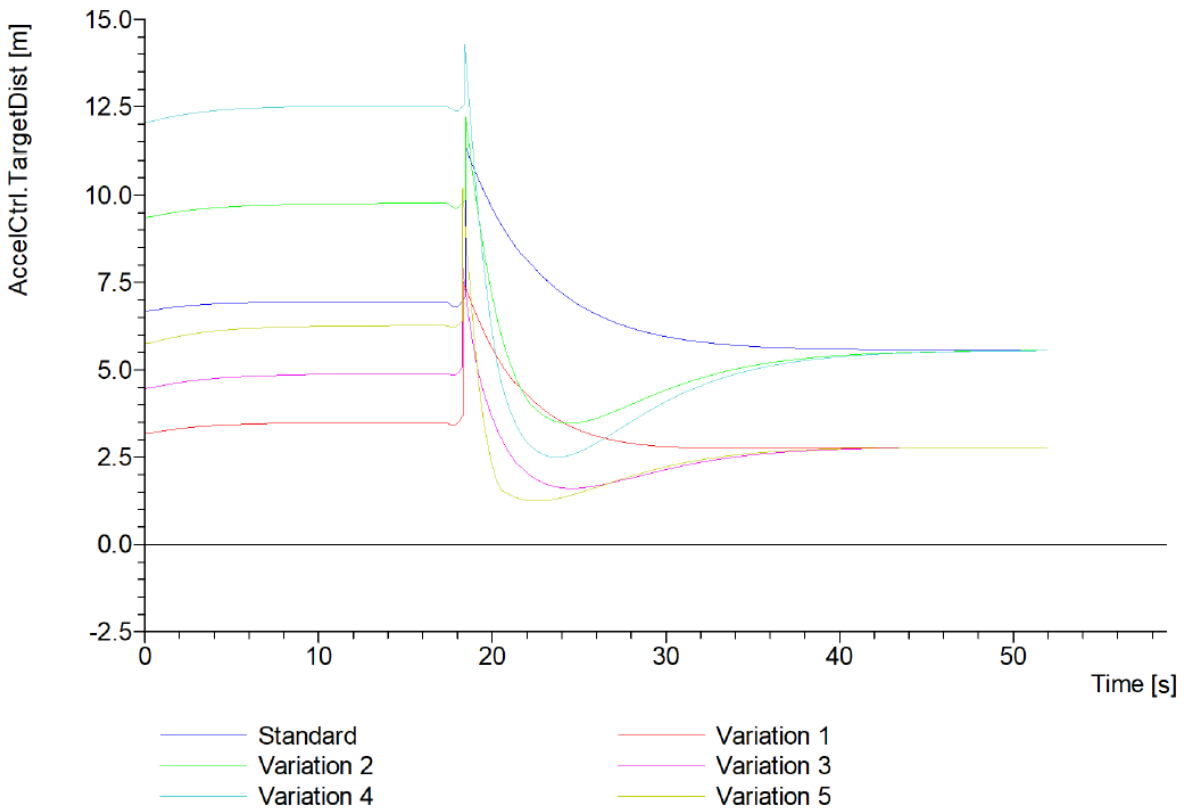

Figure 4.11: ACC-T01 AccelCtrl.TargetDist variations result graph

4.4.1.2 ACC-T02: NHTSA - Approaching a preceding vehicle

The goal of the test is to verify ACC action when a slower vehicle is detected. In Figure 4.12 is shown the detailed result chart presented in the CarMaker test manager report, while in the following graphs the quantities trends for each case are reported.

Detailed Results

ID	Test	Result
2	Scenarios/ACC/ACC-T02_NHTSA	
2.1	Standard	✓
2.2	Variation 1	✓
2.3	Variation 2	✓
2.4	Variation 3	✓
2.5	Variation 4	⚡
2.6	Variation 5	⚡

Figure 4.12: ACC-T02 test series detailed results

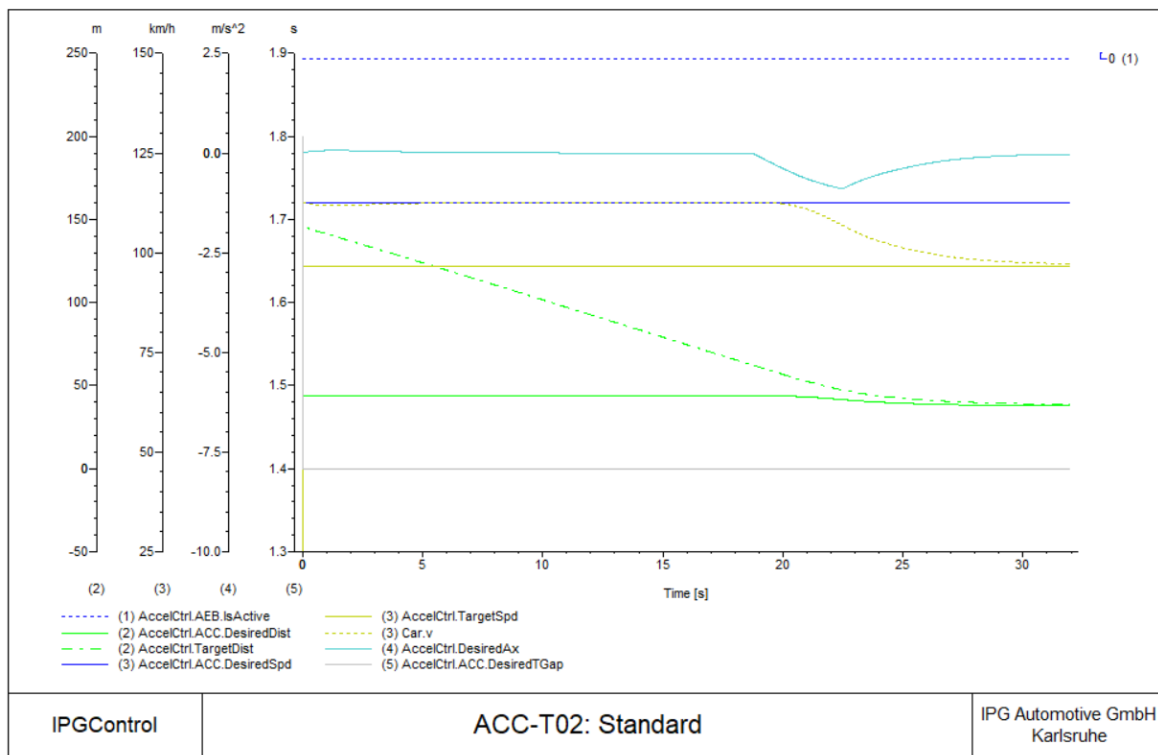

Figure 4.13: AEB-T02 Standard result graph

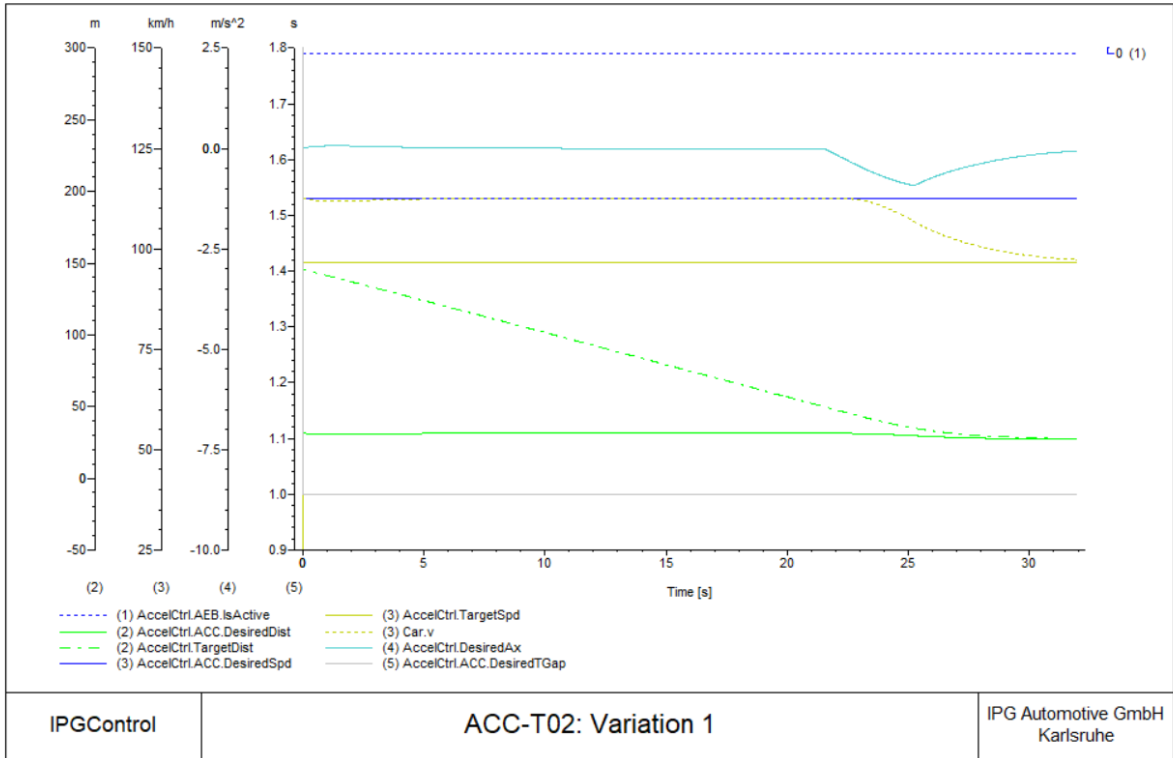

Figure 4.14: ACC-T02 Variation 1 result graph

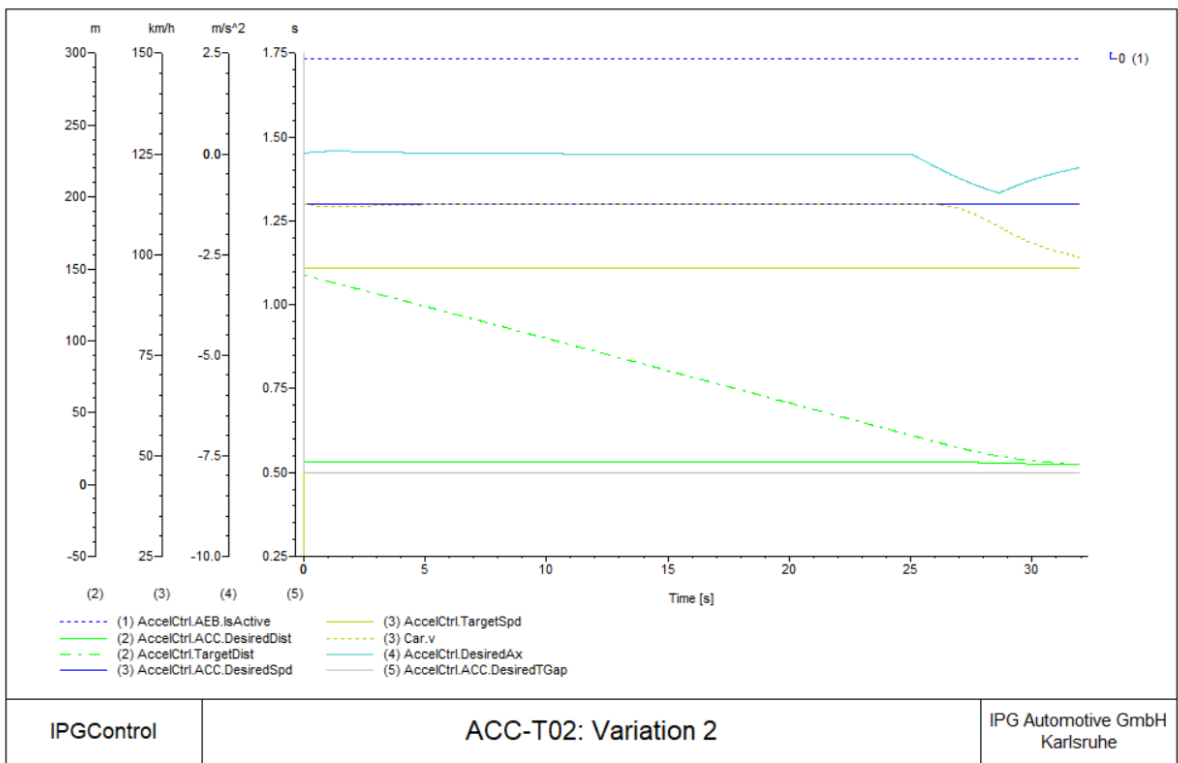

Figure 4.15: ACC-T02 Variation 2 result graph

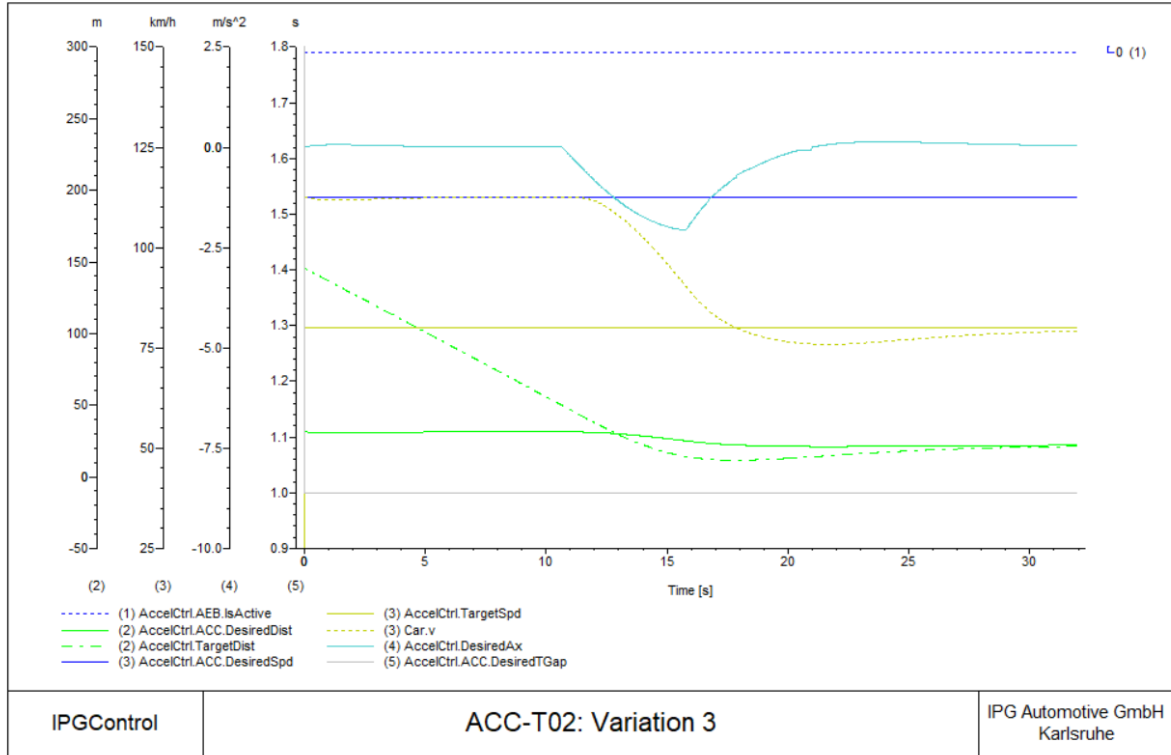

Figure 4.16: ACC-T02 Variation 3 result graph

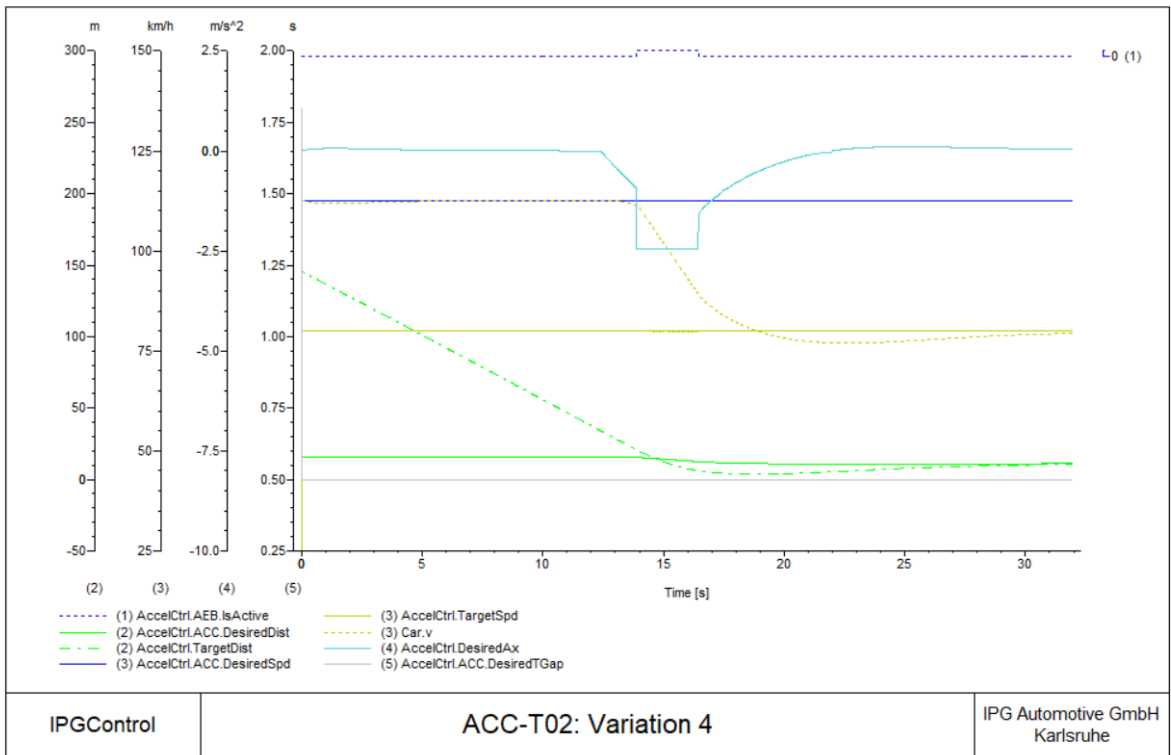

Figure 4.17: ACC-T02 Variation 4 result graph

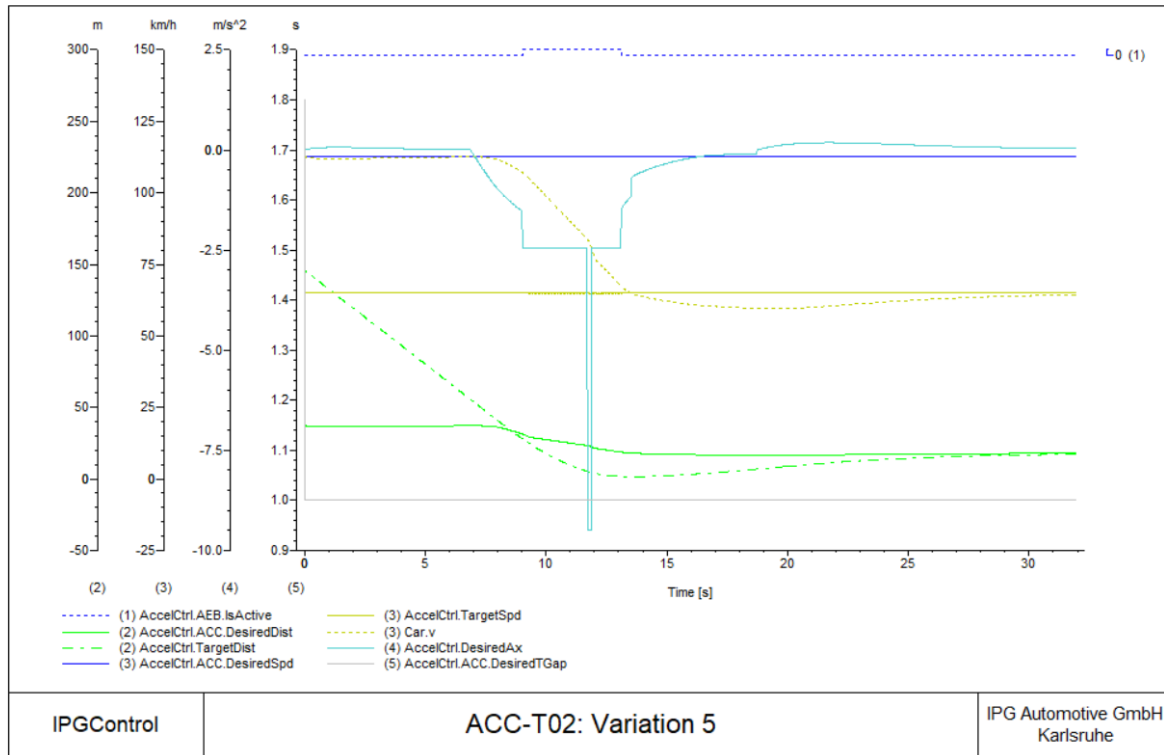

Figure 4.18: ACC-T02 Variation 5 result graph

As it is possible to see, decreasing too much the time gap or the target vehicle velocity will produce a higher deceleration request (displayed as a solid light blue line), until the AEB activation (displayed as a dotted blue line), leading to a test fail. In Standard, Variation 1, 2 and 3 the ACC was still capable of managing the situation. In Variation 4 the AEB pre-brake system activated, while in Variation 5 the full brake force was necessary in order to avoid a collision. In all cases it is possible to see how initially the host vehicle is travelling at cruise speed (displayed with a solid blue line), and then, when the target vehicle is too close, the system intervenes. The inter-vehicle distance and host car velocity (green and yellow dotted line respectively) tend to reach and follow the desired distance and the target vehicle velocity (green and yellow solid line respectively), and so the logic is performing a distance control action. To better understand the difference between the various variations, `AccelCtrl.DesiredAx` and `AccelCtrl.TargetDist` quantities are reported in Figure 4.19 and Figure 4.20, showing their trend during each test case. The two graphs reproduce the behavior of the previous diagrams, showing that decreasing the time gap, the brake request is performed later, leading in Standard, Variation 1 and 2 to a linear reduction of the distance between the two vehicles until it reaches the desired range, while in Variation 4 to an AEB activation. When decreasing the target vehicle velocity, the distance between the two vehicles reduces quicker, as the deceleration request is higher, leading to a minimum peak before reaching the desired inter-vehicle distance and so Variation 5 test to a fail.

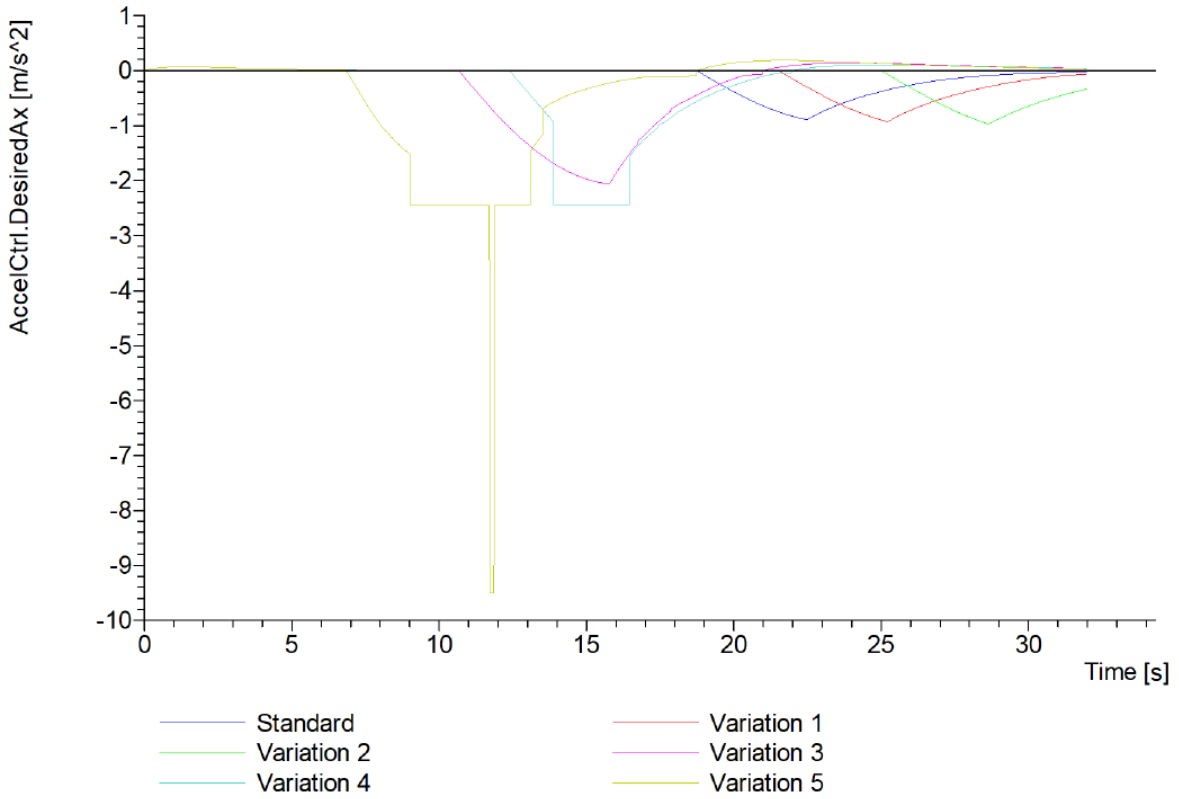

Figure 4.19: ACC-T02 AccelCtrl.DesiredAx variations result graph

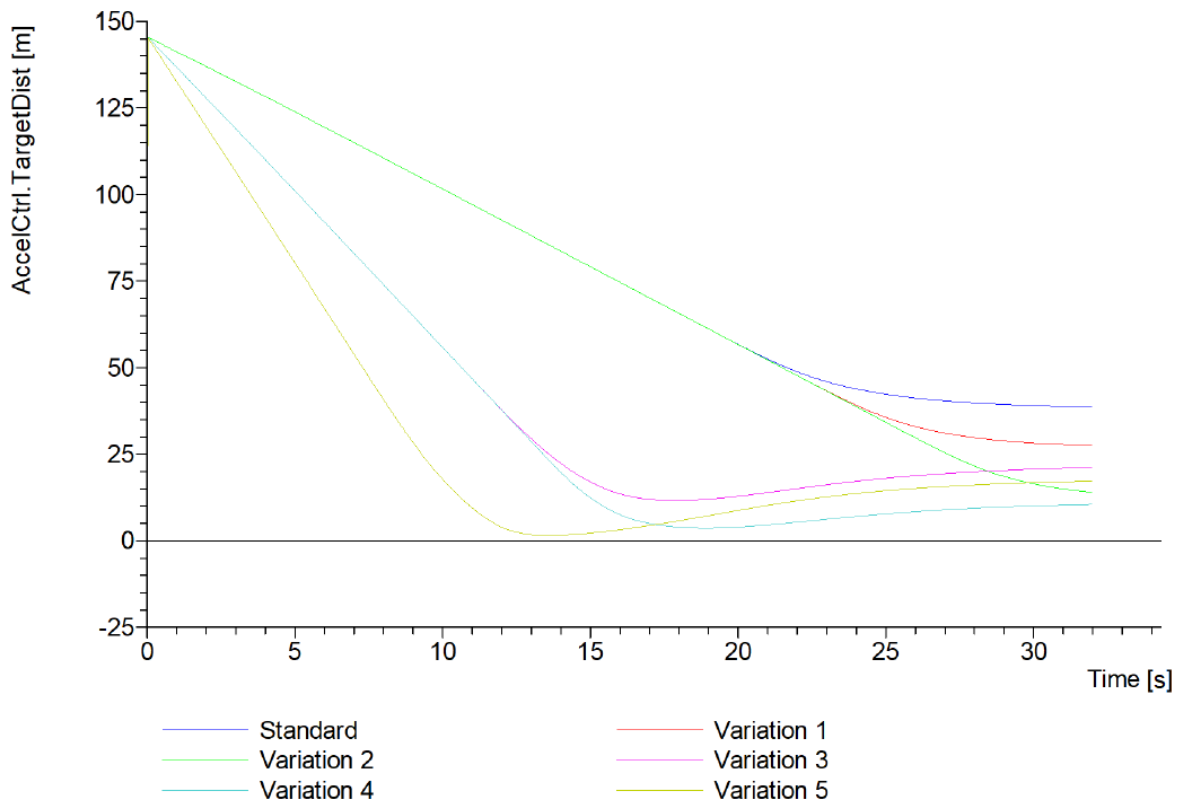

Figure 4.20: ACC-T02 AccelCtrl.TargetDist variations result graph

4.4.1.3 ACC-T03: NHTSA - Changing to a new headway

The goal of the test is to verify ACC adjustment when the desired time gap is changed. In Figure 4.21 is shown the detailed result chart presented in the CarMaker test manager report, while in the following graphs the quantities trends for each case are reported.

Detailed Results

ID	Test	Result
3	Scenarios/ACC/ACC-T03_NHTSA	
3.1	Standard 1	✓
3.2	Standard 2	✓
3.3	Standard 3	✓
3.4	Standard 4	✓
3.5	Variation 1	✓
3.6	Variation 2	✓

Figure 4.21: ACC-T03 test series detailed results

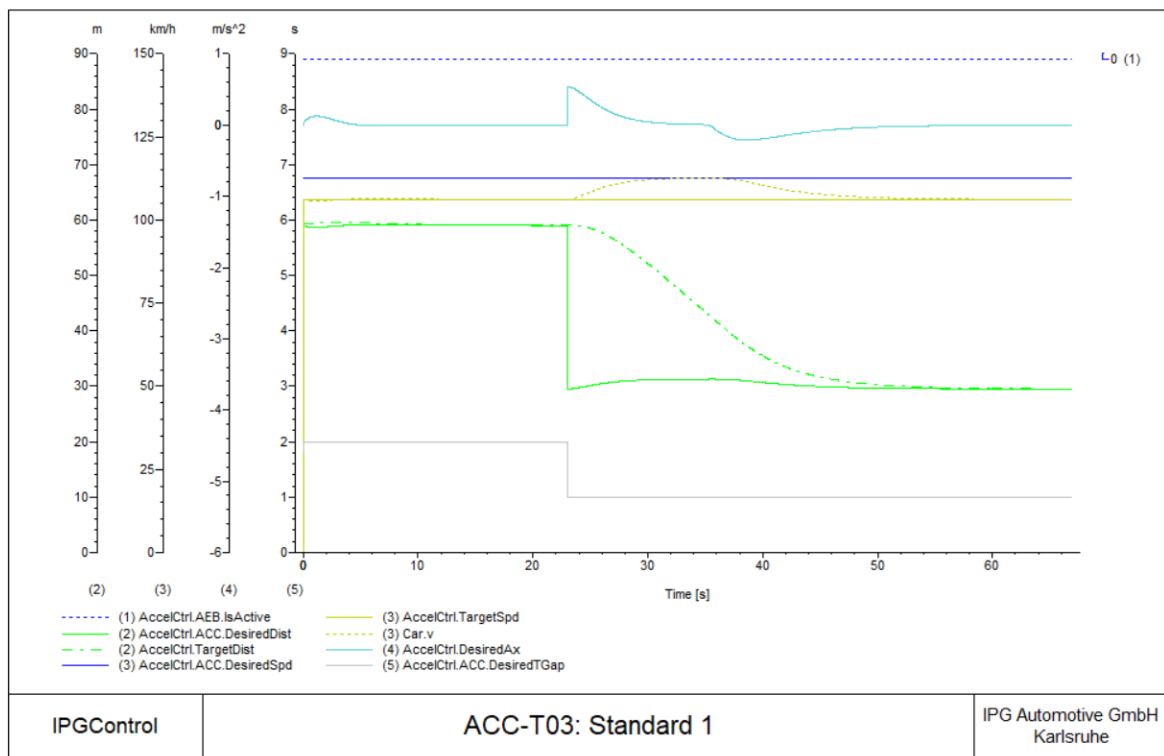

Figure 4.22: AEB-T03 Standard 1 result graph

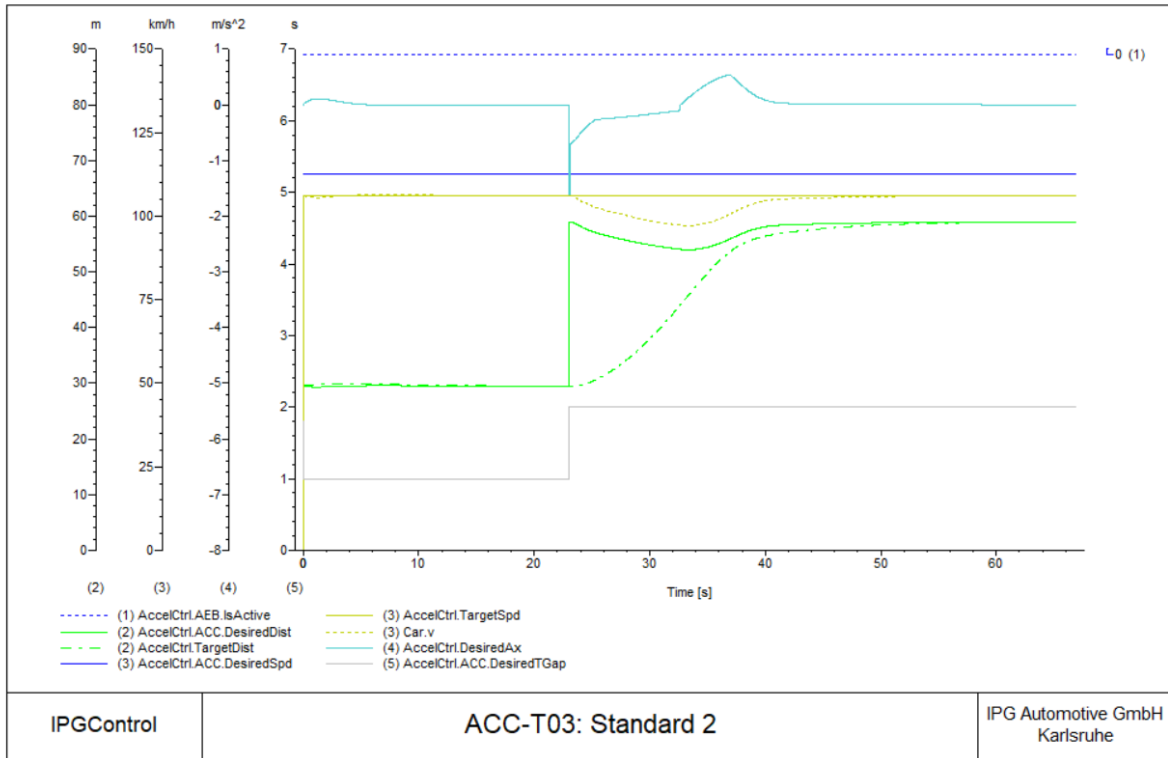

Figure 4.23: AEB-T03 Standard 2 result graph

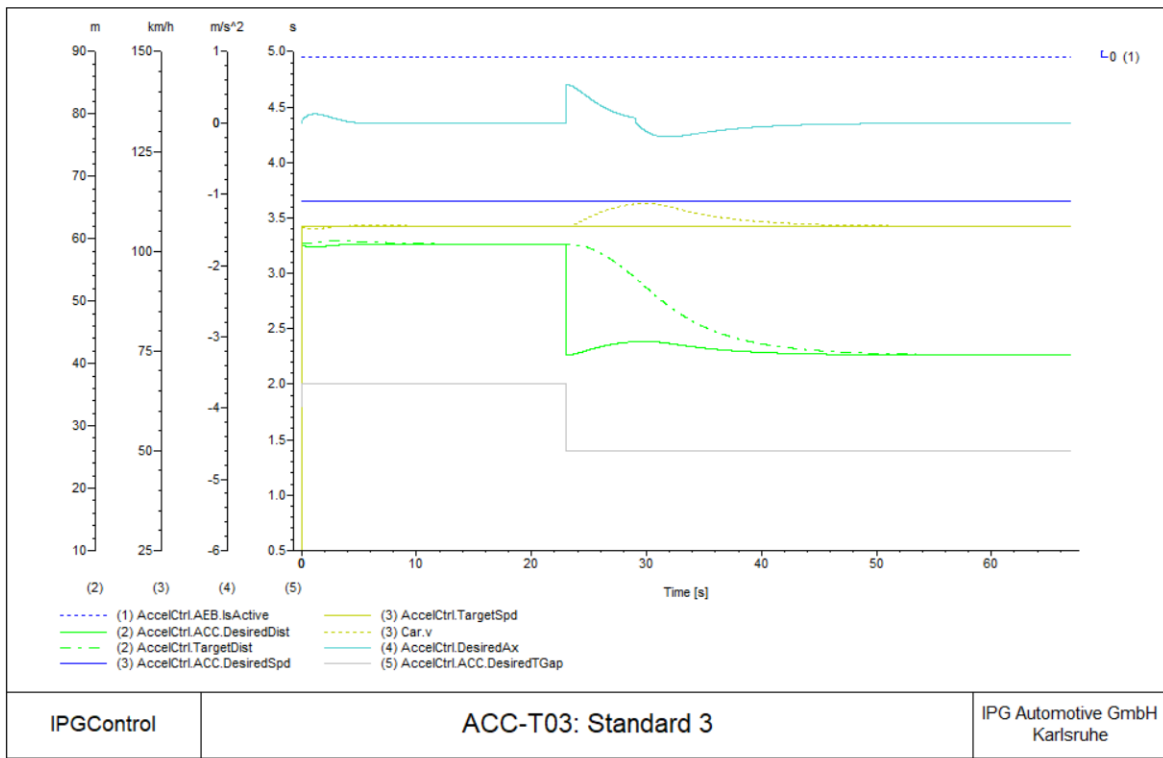

Figure 4.24: AEB-T03 Standard 3 result graph

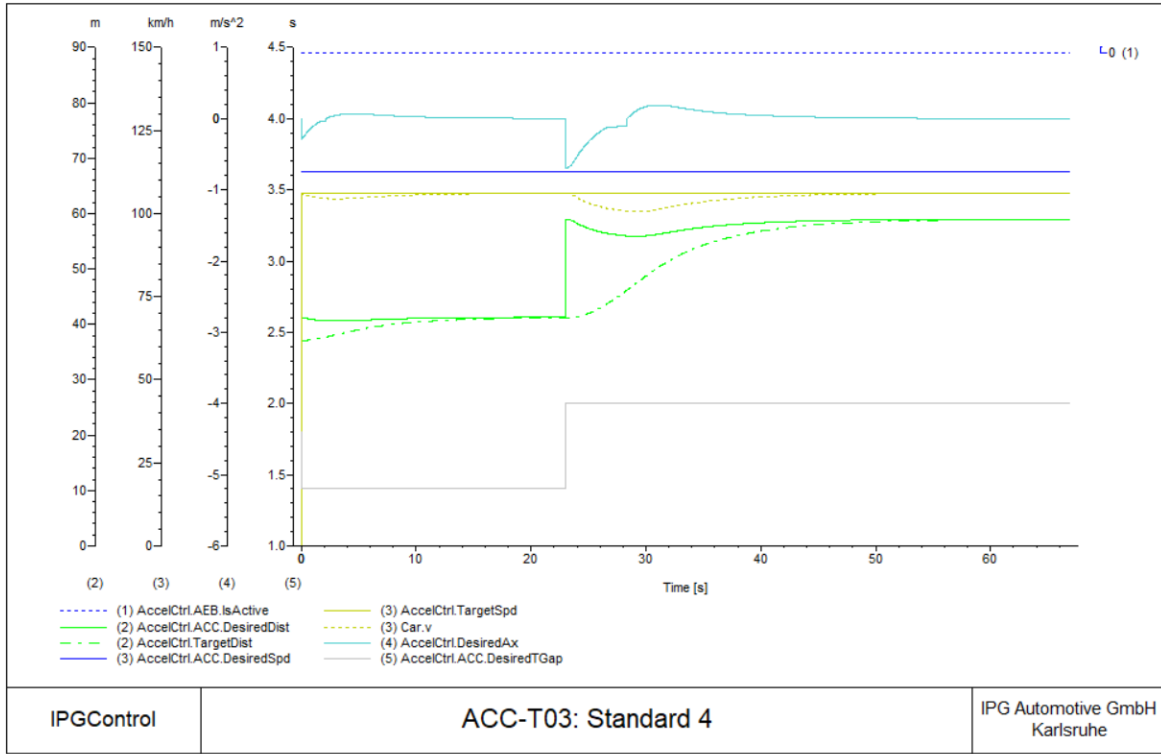

Figure 4.25: AEB-T03 Standard 4 result graph

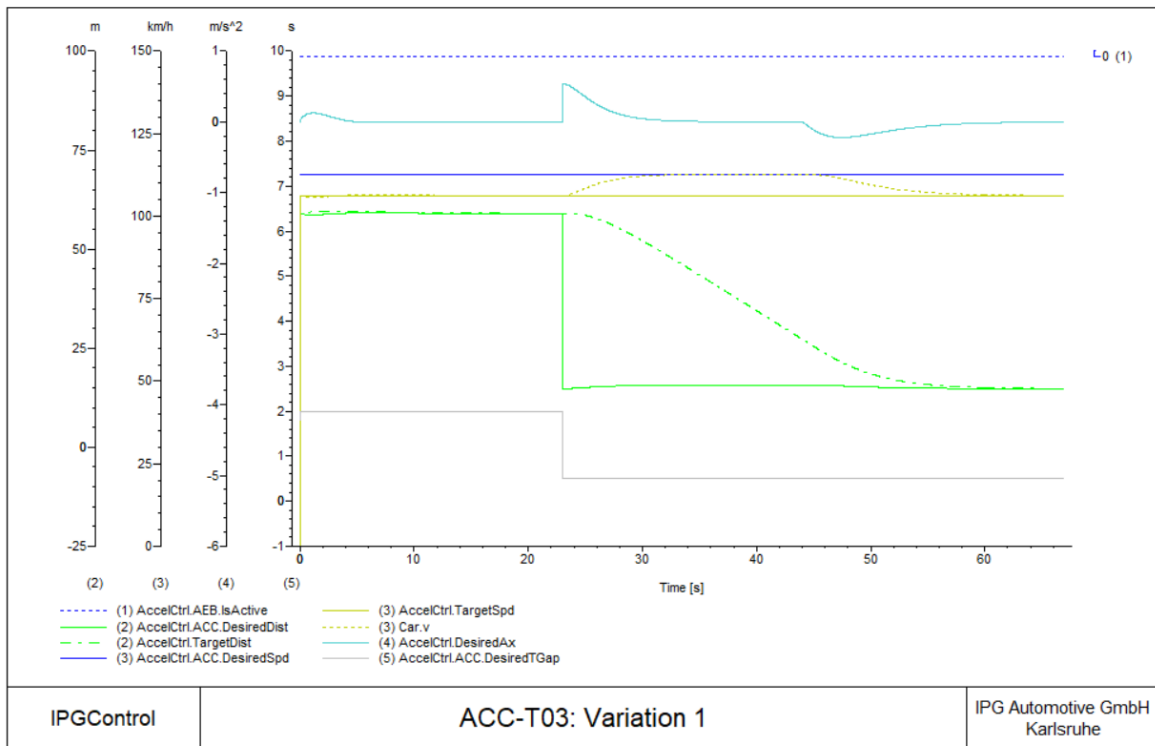

Figure 4.26: ACC-T03 Variation 1 result graph

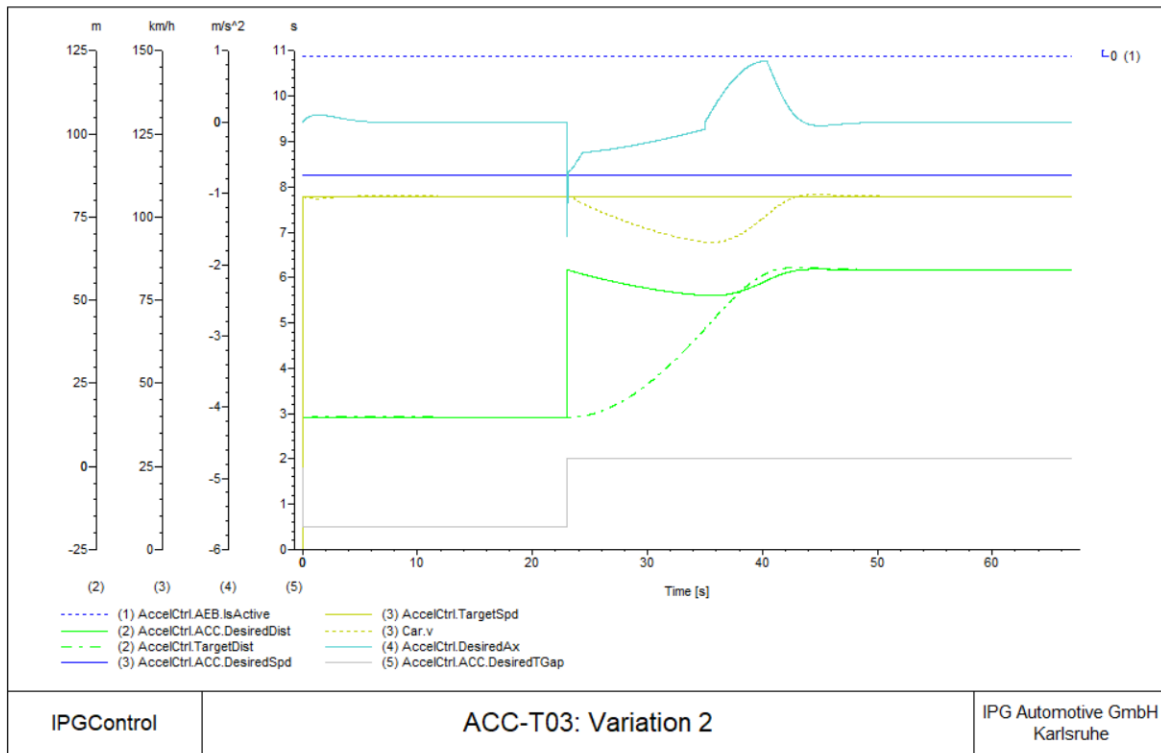

Figure 4.27: ACC-T03 Variation 2 result graph

As it is possible to see from the result chart, this test is not a particular critical one. Starting from a stable condition, the time gap is suddenly changed, causing the ACC system to react. Even in the Variation 1 and 2 tests, where a big time gap jump is performed, it is possible to see how the inter-vehicle distance and host car velocity (green and yellow dotted line respectively) tend to reach and follow the desired distance and the target vehicle velocity (green and yellow solid line respectively). The desired speed, displayed with a solid blue line, has a higher value, and so the logic is performing a distance control action. To better understand the difference between the various variations, `AccelCtrl.DesiredAx` and `AccelCtrl.TargetDist` quantities are reported in Figure 4.28 and Figure 4.29, showing their trend during each test case. The two graphs reproduce the behavior of the previous diagrams, showing the different curves trends. In all cases the distance between the two vehicles decrease or increase linearly, until it reaches the desired range, except for Variation 2 test, where it is possible to notice a peak due to a harder braking. Moreover, for this reason, the Variation 2 case acceleration curve has got the higher peak, in order to reach the desired distance as soon as possible.

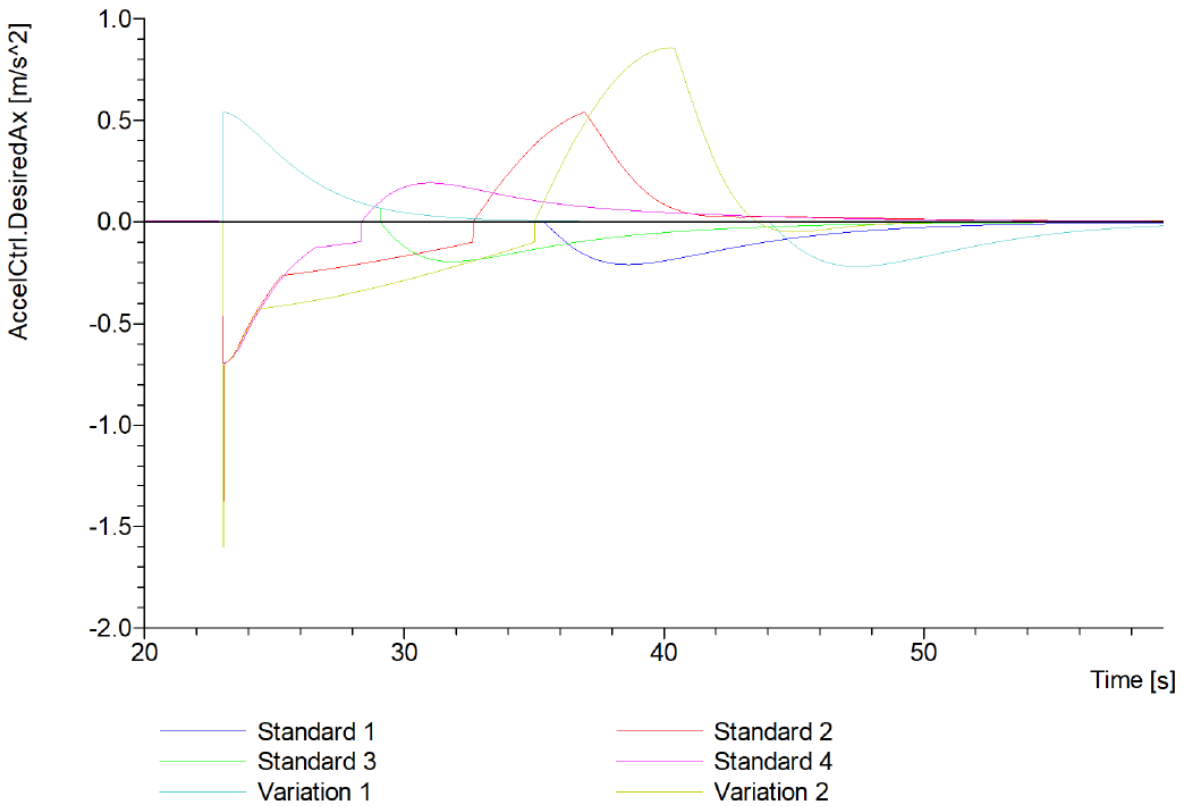

Figure 4.28: ACC-T03 AccelCtrl.DesiredAx variations result graph

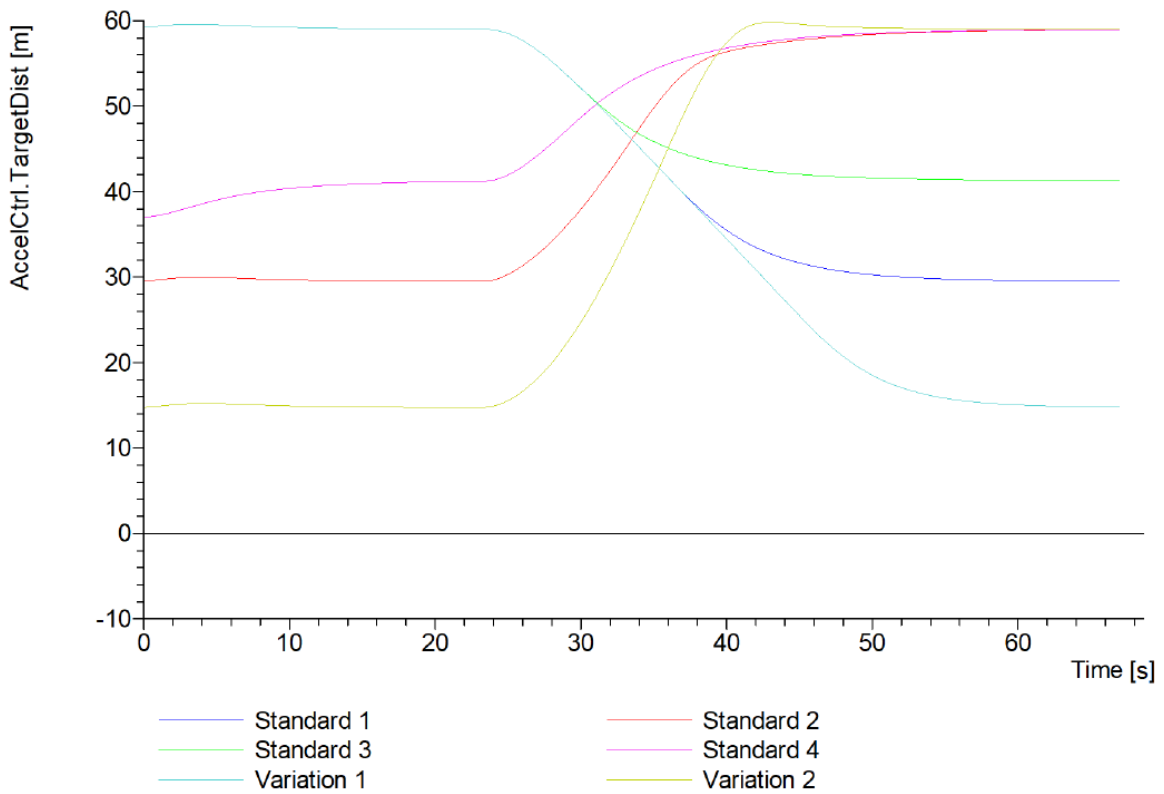

Figure 4.29: ACC-T03 AccelCtrl.TargetDist variations result graph

4.4.1.4 ACC-T04: NHTSA - Manually accelerating and near encounter

The goal of the test is to verify the gas pedal override capability as well as to evaluate the ACC response to a near target vehicle encounter. In Figure 4.30 is shown the detailed result chart presented in the CarMaker test manager report, while in the following graphs the quantities trends for each case are reported.

Detailed Results

ID	Test	Result
4	Scenarios/ACC/ACC-T04_NHTSA	
4.1	Standard	✓
4.2	Variation 1	✓
4.3	Variation 2	✓
4.4	Variation 3	✓
4.5	Variation 4	⚡
4.6	Variation 5	⚡

Figure 4.30: ACC-T04 test series detailed results

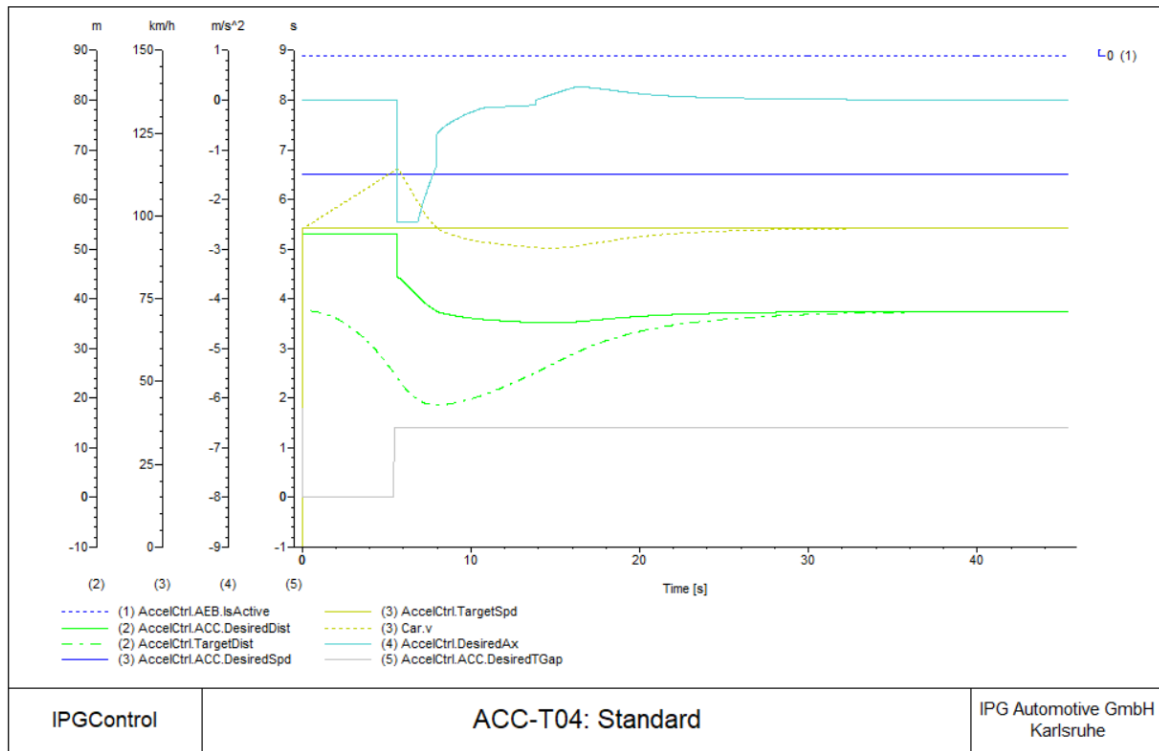
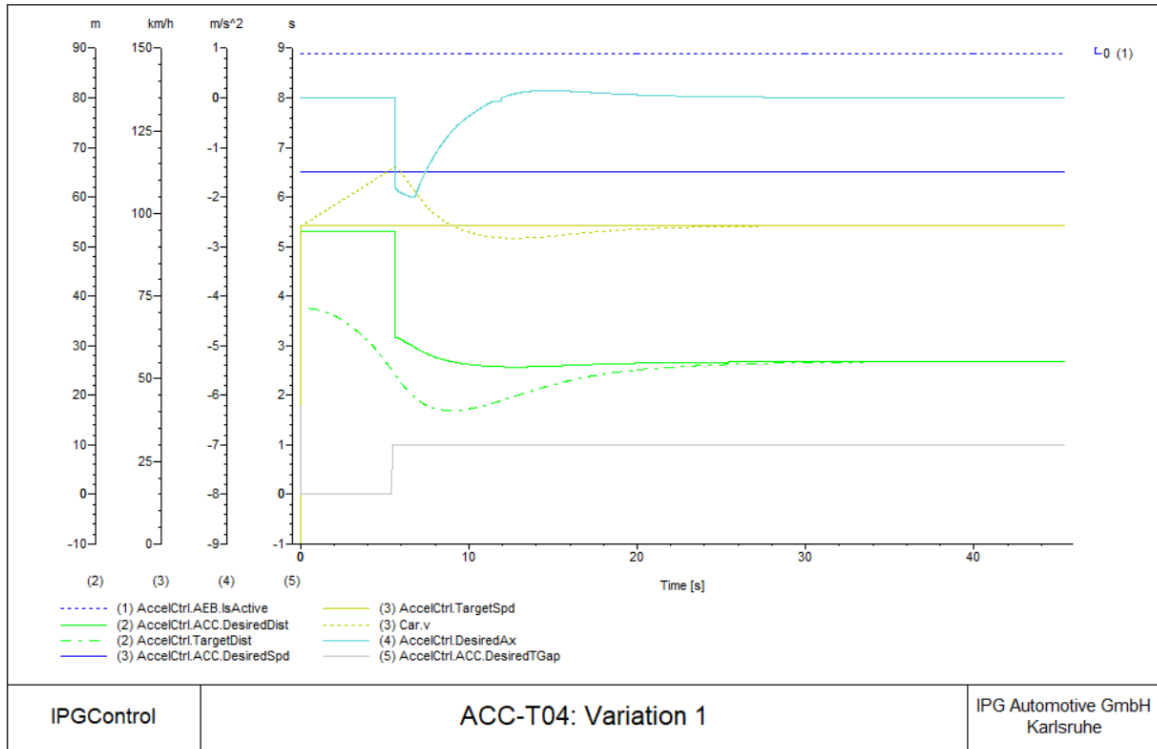
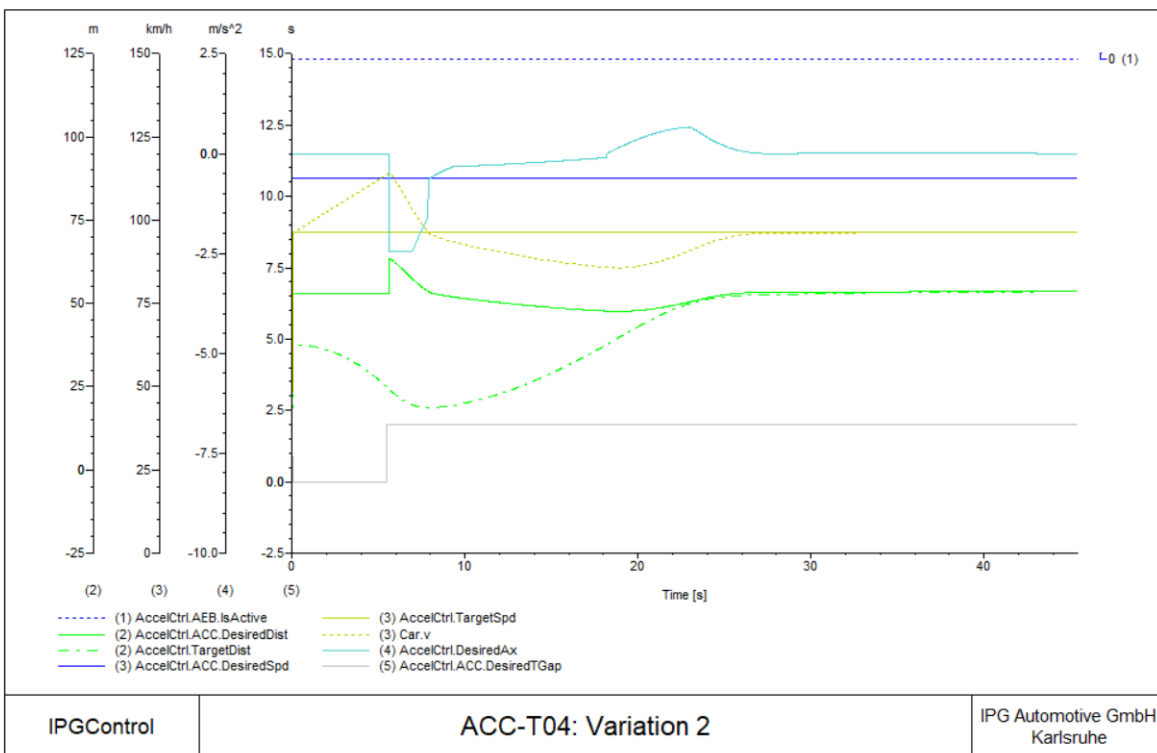

Figure 4.31: AEB-T04 Standard result graph



13.06.18 - 17.23

Figure 4.32: ACC-T04 Variation 1 result graph



13.06.18 - 17.27

Figure 4.33: ACC-T04 Variation 2 result graph

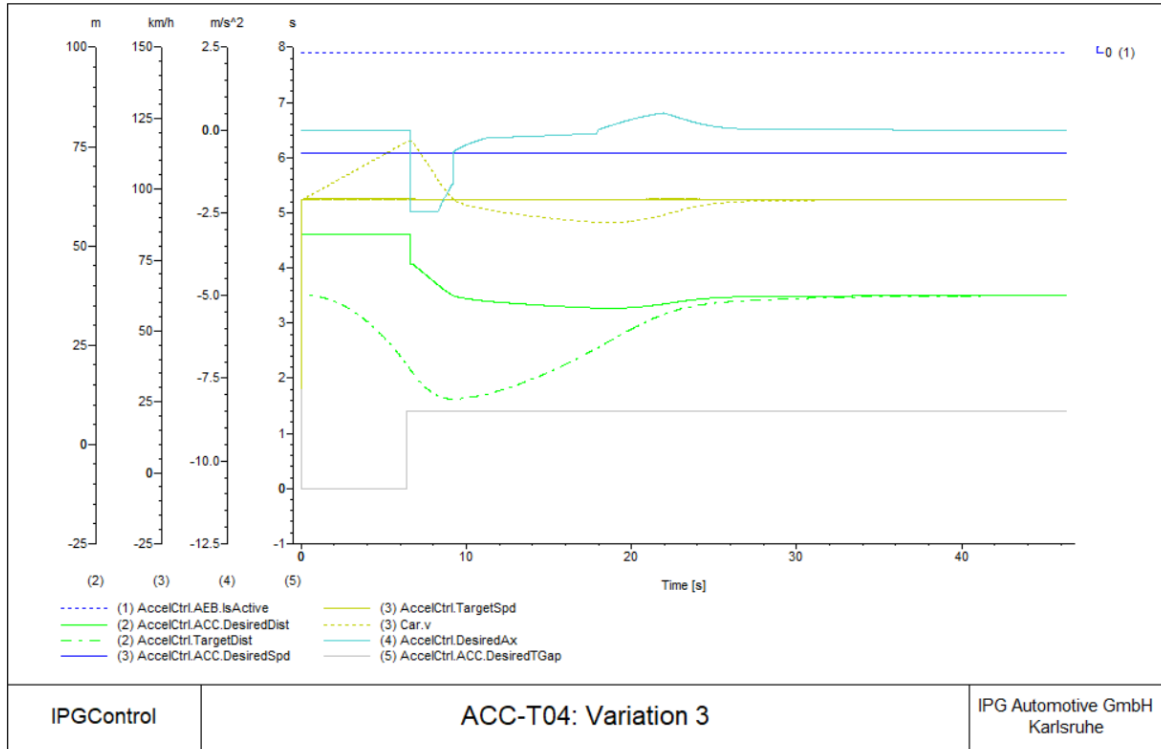

13.06.18 - 17:31

Figure 4.34: ACC-T04 Variation 3 result graph

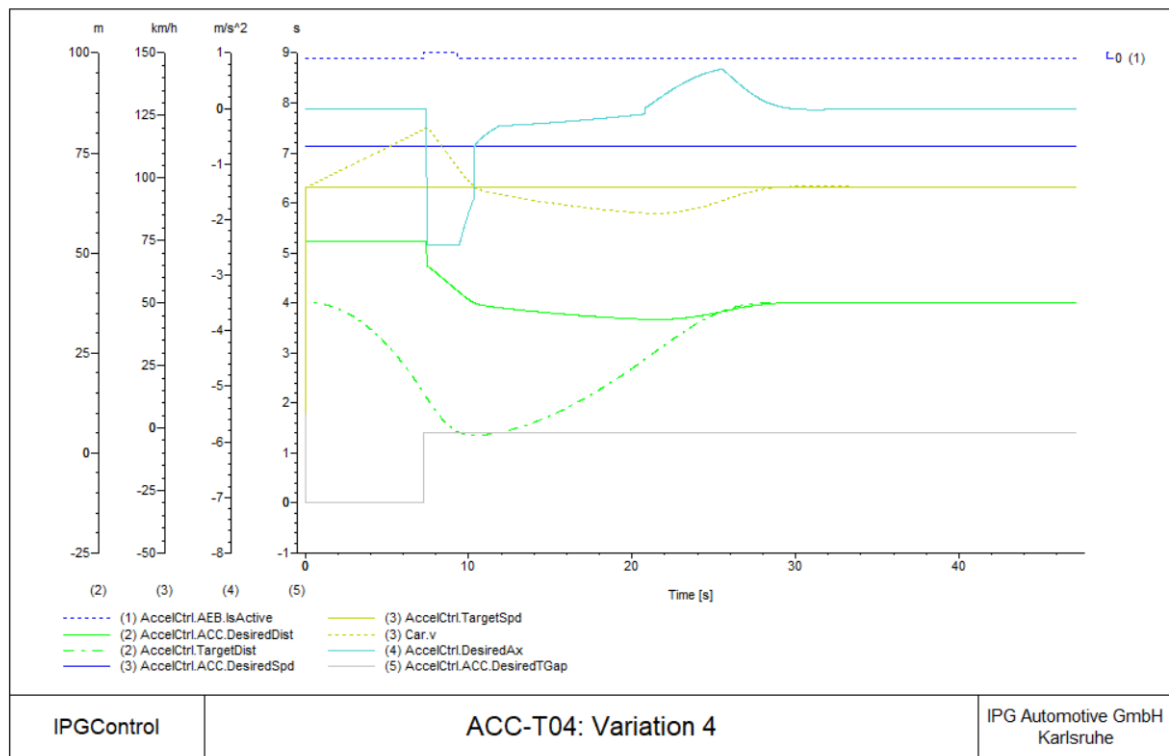

13.06.18 - 17:36

Figure 4.35: ACC-T04 Variation 4 result graph

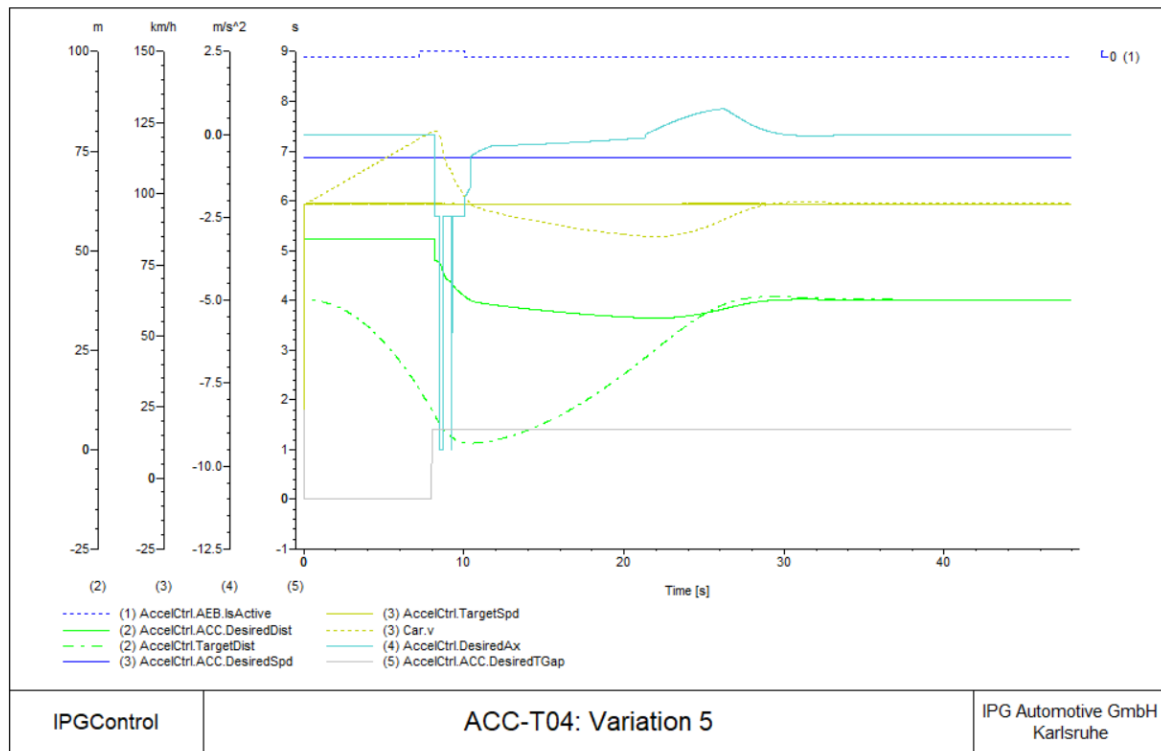

Figure 4.36: ACC-T04 Variation 5 result graph

As it is possible to see, decreasing the time gap will only affect the braking start time of the ACC system, as well as the final desired distance. A critical situation instead occurs when the driver continues to accelerate for more time before letting the system to intervene. This lead Variation 4 and 5 to a test fail, with a pre-brake and emergency brake activation respectively. In all cases it is possible to see how, in the first part of the graphs, the inter-vehicle distance (green dotted line) reduces against the safety distance requirement, as well as the host car velocity (yellow dotted line) increases over the target speed and even over the maximum desired speed. The situation changes once the system takes the VUT control, as the host vehicle brakes in order to reach and follow the desired distance and the target vehicle velocity (green and yellow solid line respectively). The desired speed, displayed with a solid blue line, has a higher value, and so the logic is performing a distance control action. To better understand the difference between the various variations, `AccelCtrl.DesiredAx` and `AccelCtrl.TargetDist` quantities are reported in Figure 4.37 and Figure 4.38, showing their trend during each test case. The two graphs reproduce the behavior of the previous diagrams, showing that decreasing the time gap, the brake request is performed later, while when delaying the ACC system activation, the distance between the two vehicles reduces quicker, as the deceleration request is higher, leading to a minimum peak before reaching the desired inter-vehicle distance and so Variation 4 and 5 tests to a fail.

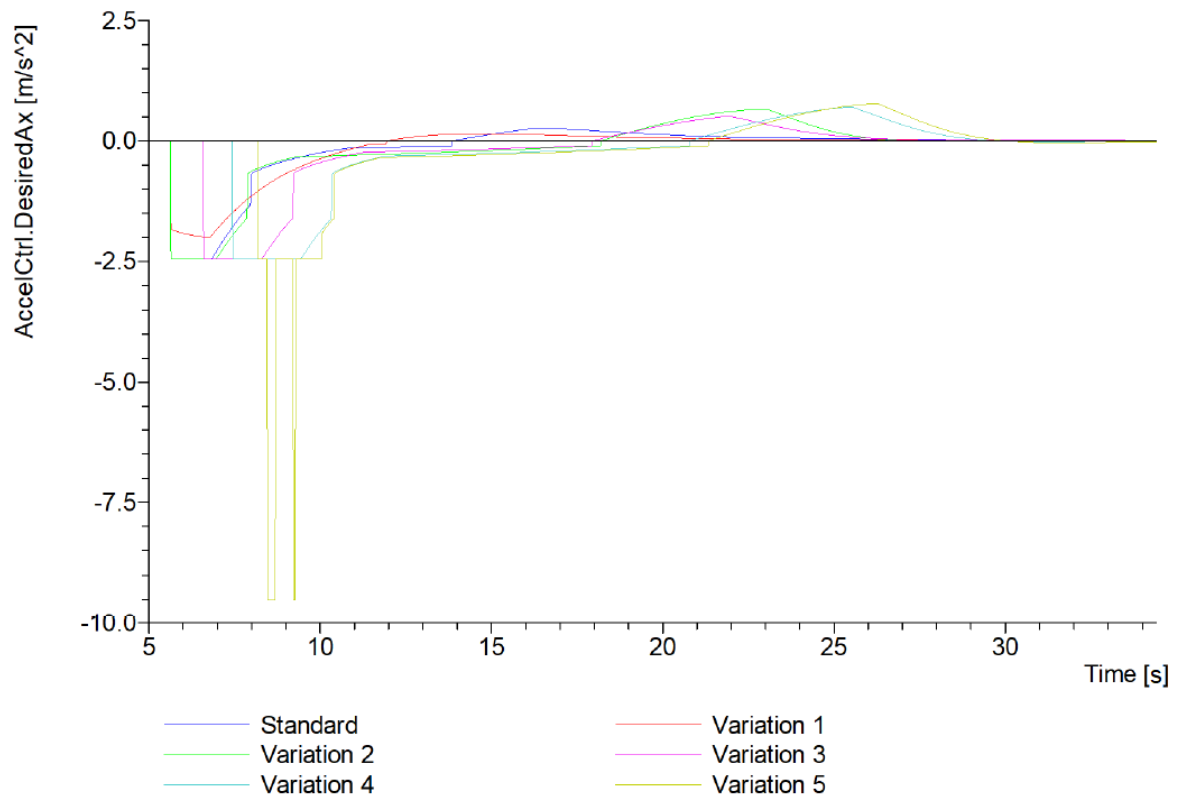

Figure 4.37: ACC-T04 AccelCtrl.DesiredAx variations result graph

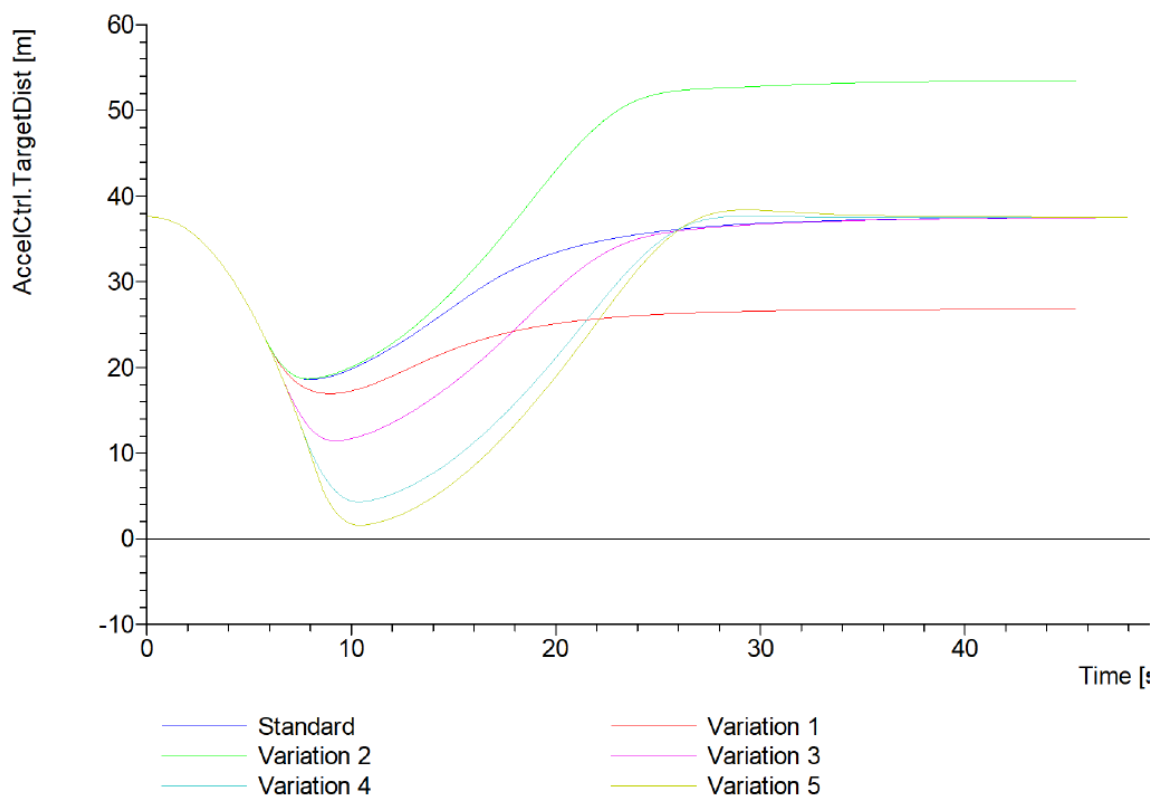

Figure 4.38: ACC-T04 AccelCtrl.TargetDist variations result graph

4.4.1.5 ACC-T05: CTU-F – Lane change vehicle interaction

This test is focused on evaluating the promptness of the ACC system in case of the presence of a target vehicle after performing a lane change. In Figure 4.39 is shown the detailed result chart presented in the CarMaker test manager report, while in the following graphs the quantities trends for each case are reported.

Detailed Results

ID	Test	Result
5	Scenarios/ACC/ACC-T05_CTU-F	
5.1	Standard	✓
5.2	Variation 1	✓
5.3	Variation 2	✓
5.4	Variation 3	✓
5.5	Variation 4	⚡
5.6	Variation 5	⚡

Figure 4.39: ACC-T05 test series detailed results

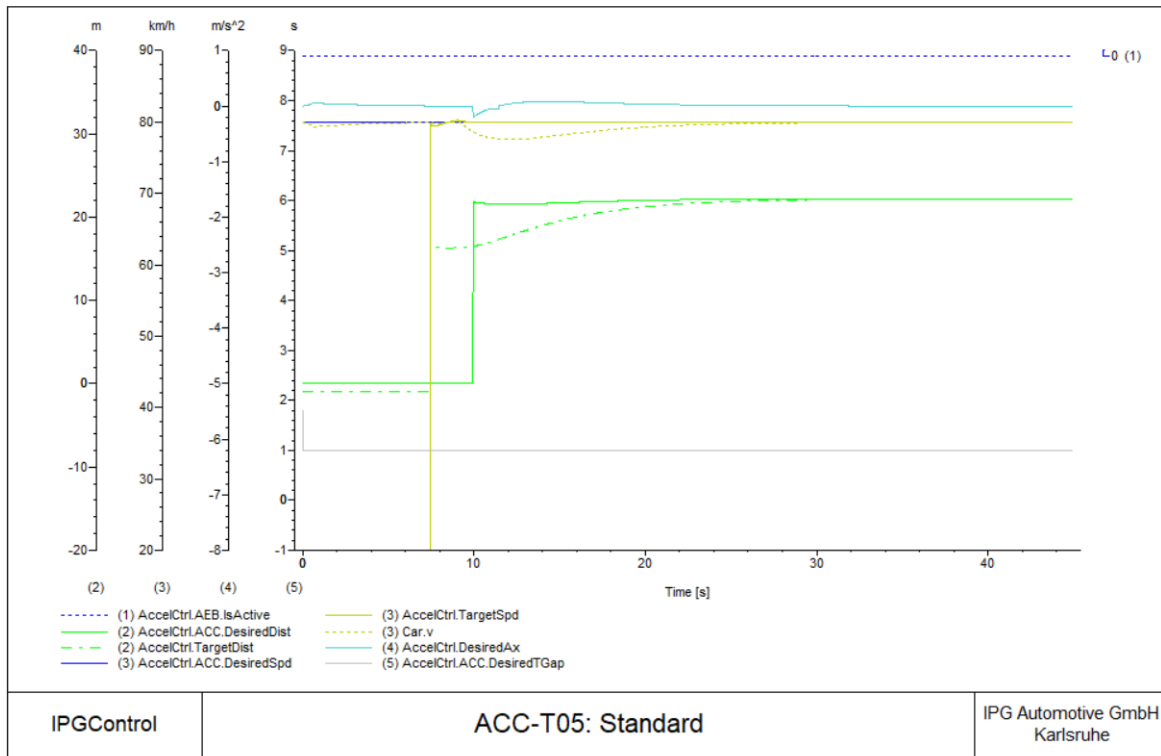

Figure 4.40: AEB-T05 Standard result graph

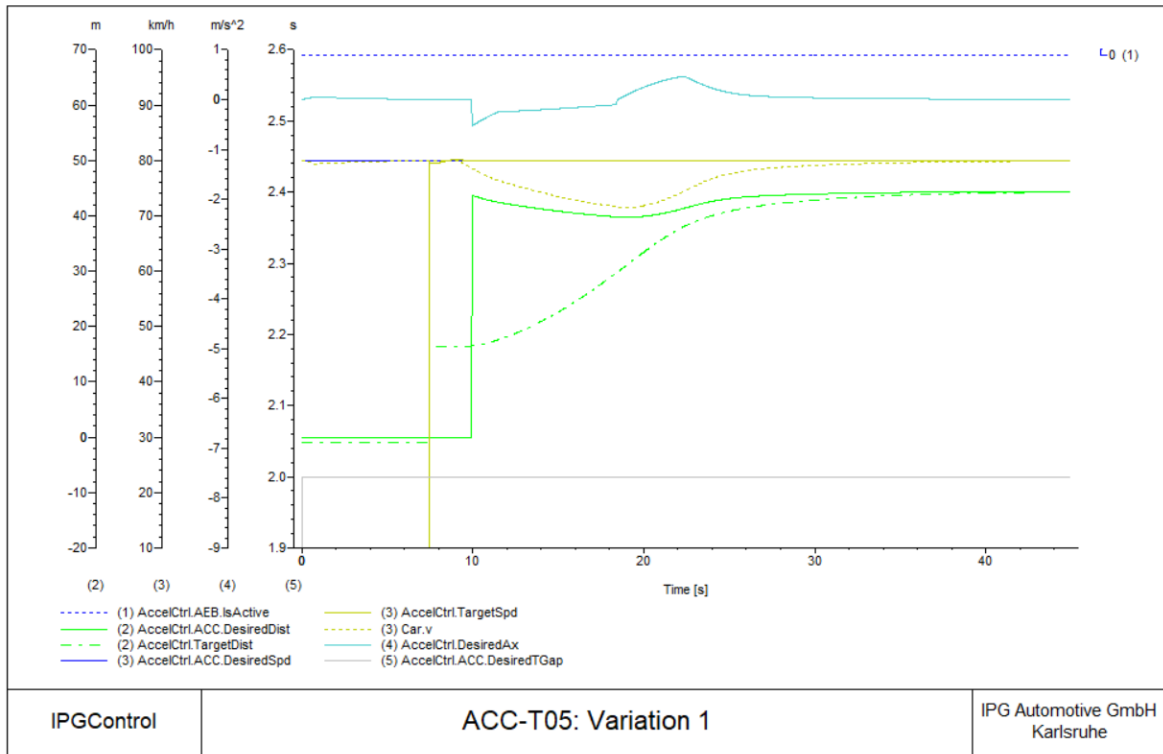

Figure 4.41: ACC-T05 Variation 1 result graph

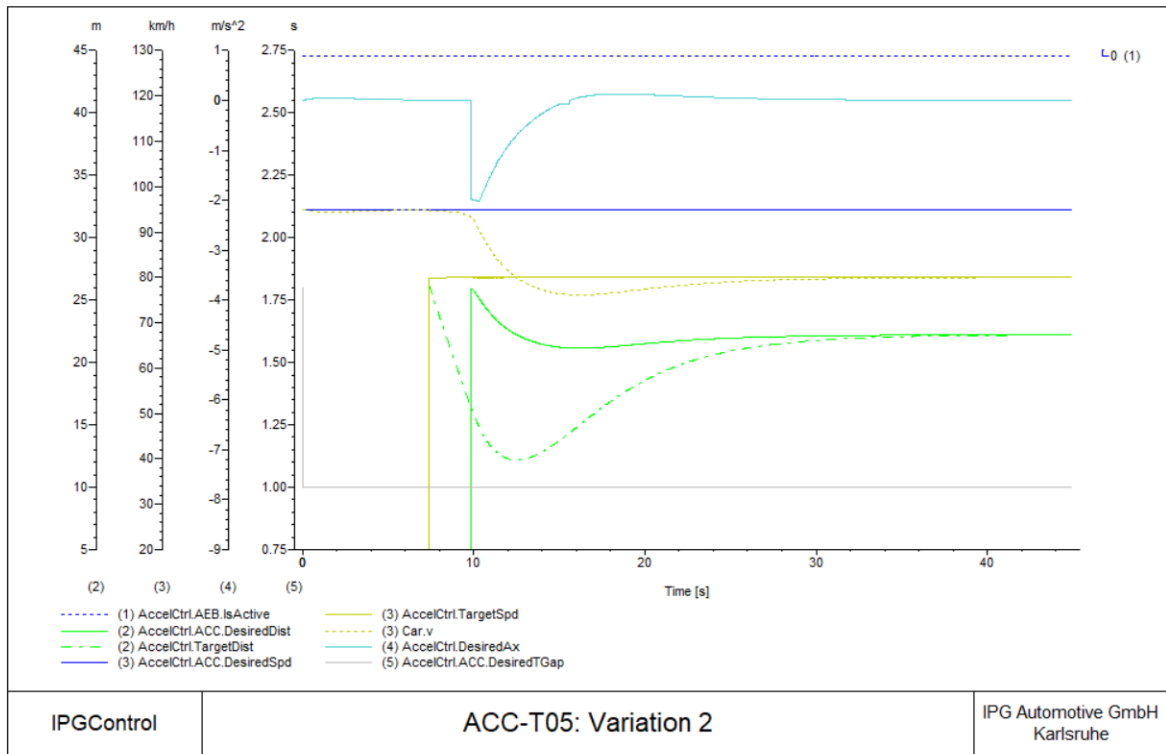

Figure 4.42: ACC-T05 Variation 2 result graph

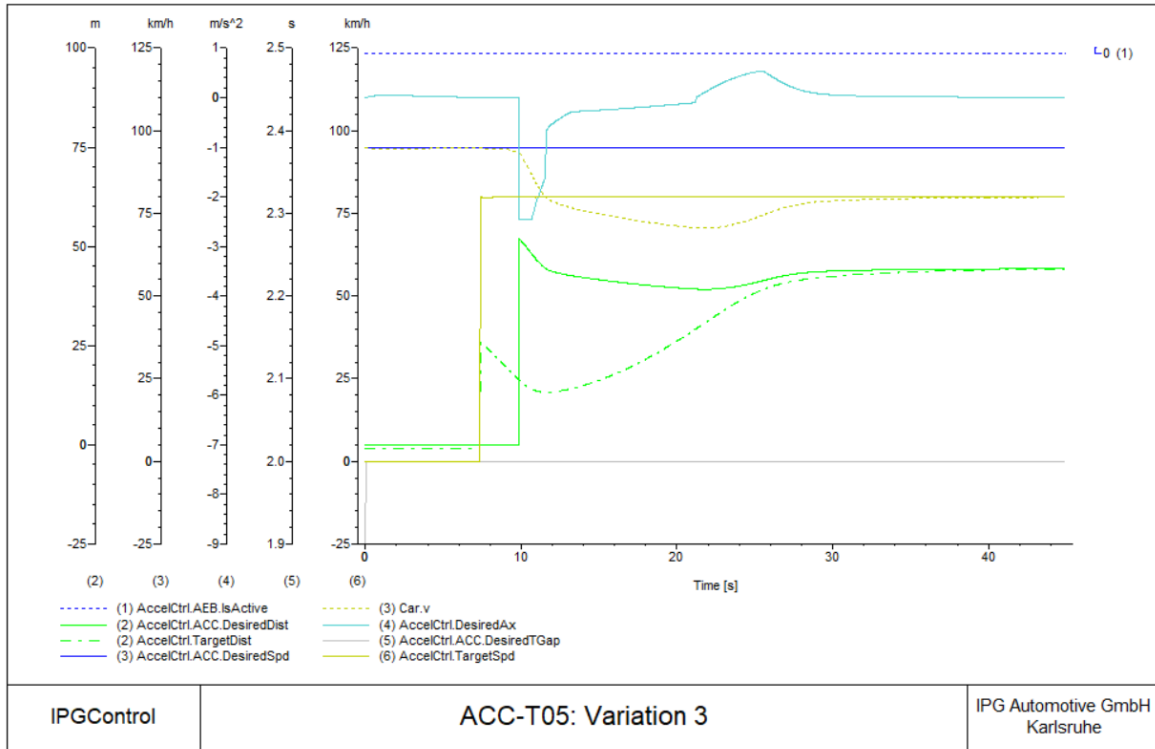

Figure 4.43: ACC-T05 Variation 3 result graph

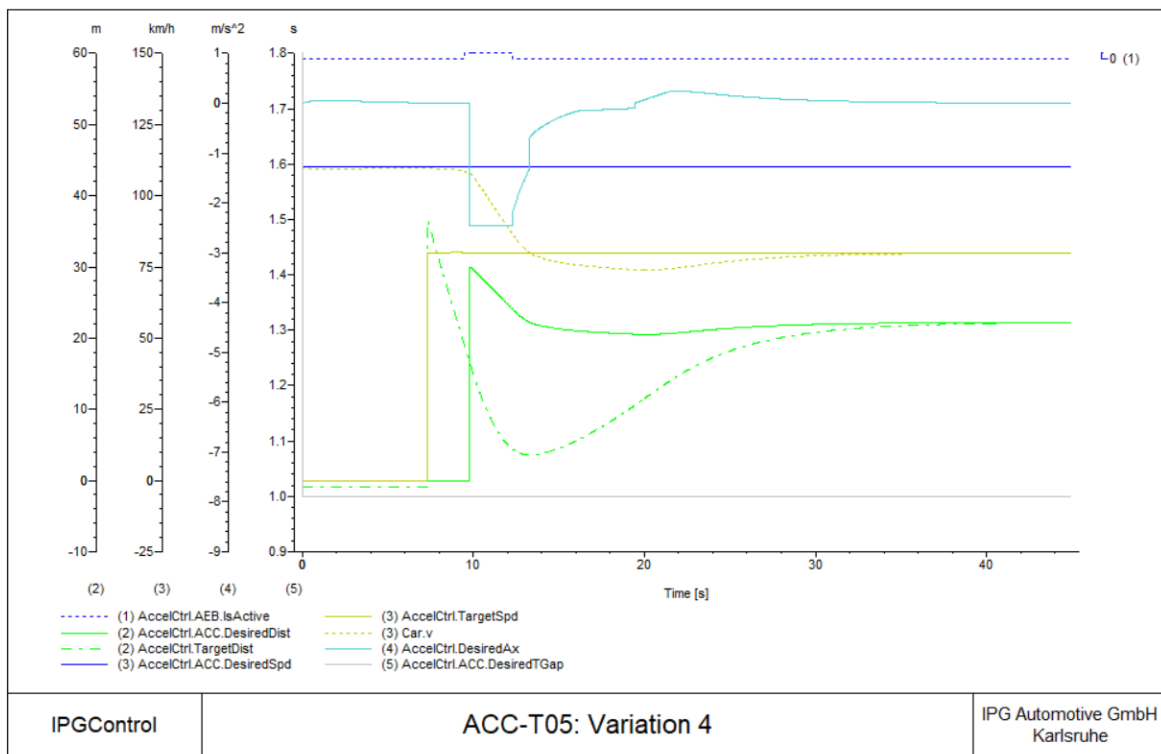

Figure 4.44: ACC-T05 Variation 4 result graph

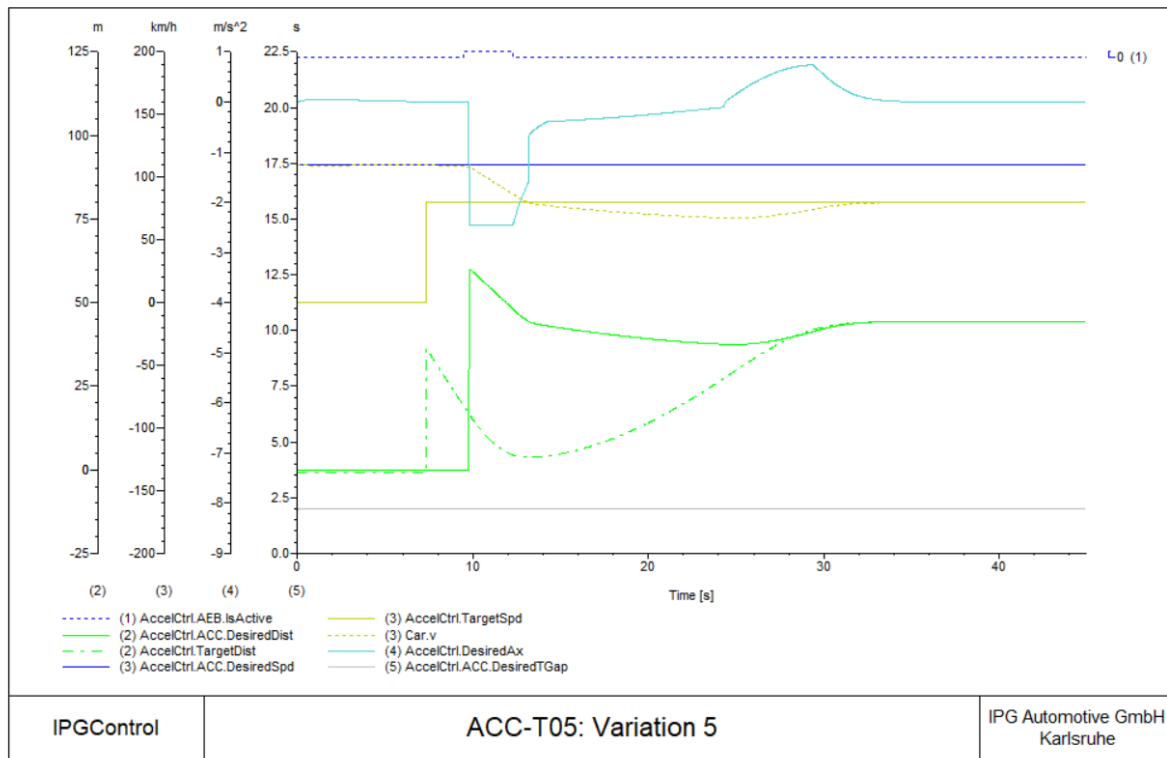

Figure 4.45: ACC-T05 Variation 5 result graph

As it is possible to see, increasing the time gap or the host vehicle velocity will produce a higher deceleration request (displayed as a solid light blue line), until the AEB activation (displayed as a dotted blue line), leading to a test fail. In Standard, Variation 1, 2 and 3 the ACC was still capable of managing the situation, while in Variation 4 and 5 the AEB pre-brake system activated. In all cases it is possible to see how the host vehicle velocity starts saturated at the desired speed, not being any target ahead and so with the velocity controller logic active. After the lane change is performed, the sensor detects a target vehicle, but the ACC system does not intervene until the driver had finished to steer. After the system activates, the inter-vehicle distance and host car velocity (green and yellow dotted line respectively) will tend to reach and follow the desired distance and the target vehicle velocity (green and yellow solid line respectively), performing a distance control action. To better understand the difference between the various variations, AccelCtrl.DesiredAx and AccelCtrl.TargetDist quantities are reported in Figure 4.46 and Figure 4.47, showing their trend during each test case. The two graphs reproduce the behavior of the previous diagrams, showing that increasing the time gap, will produce a higher brake and acceleration request, respectively in the first and in the second part of the test, leading Variation 5 inter-vehicle distance to a maximum peak before reaching the stable condition. The same occurs increasing the host vehicle velocity, as the deceleration request is higher, leading to a minimum peak before reach the desired inter-vehicle distance and so Variation 4 and 5 tests to a fail.

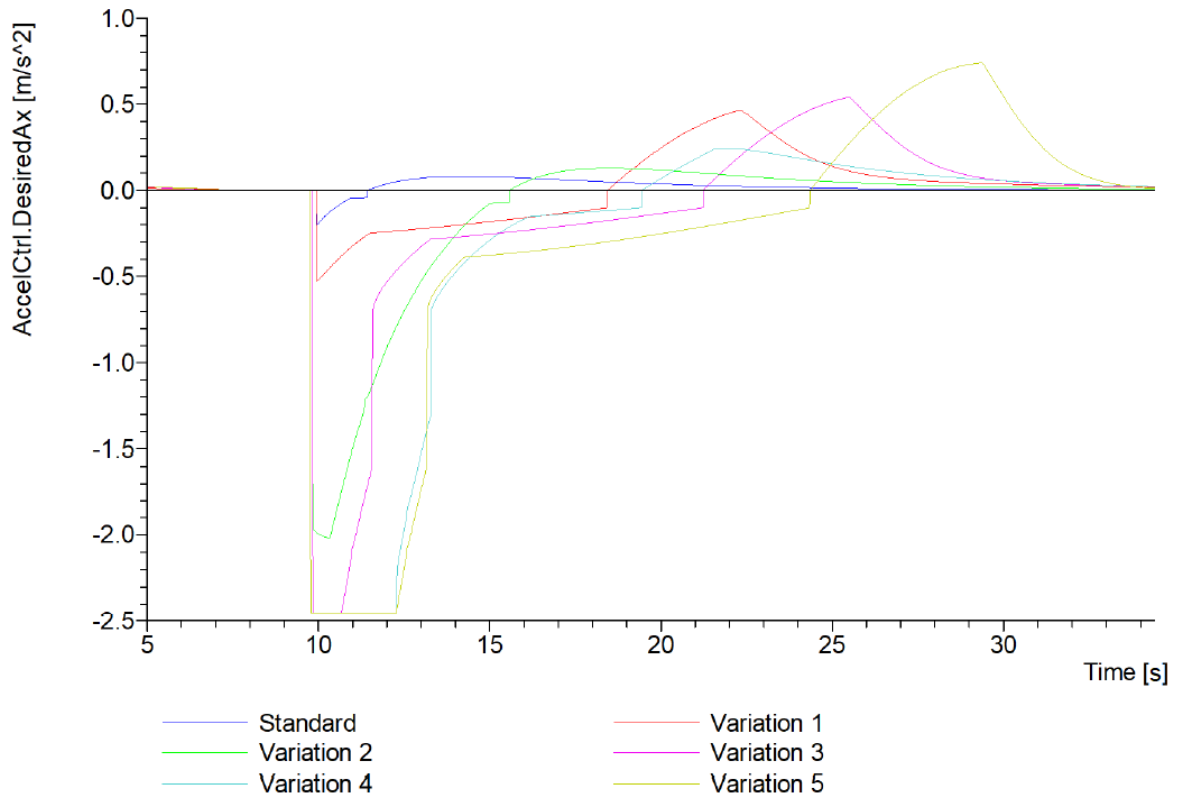

Figure 4.46: ACC-T05 AccelCtrl.DesiredAx variations result graph

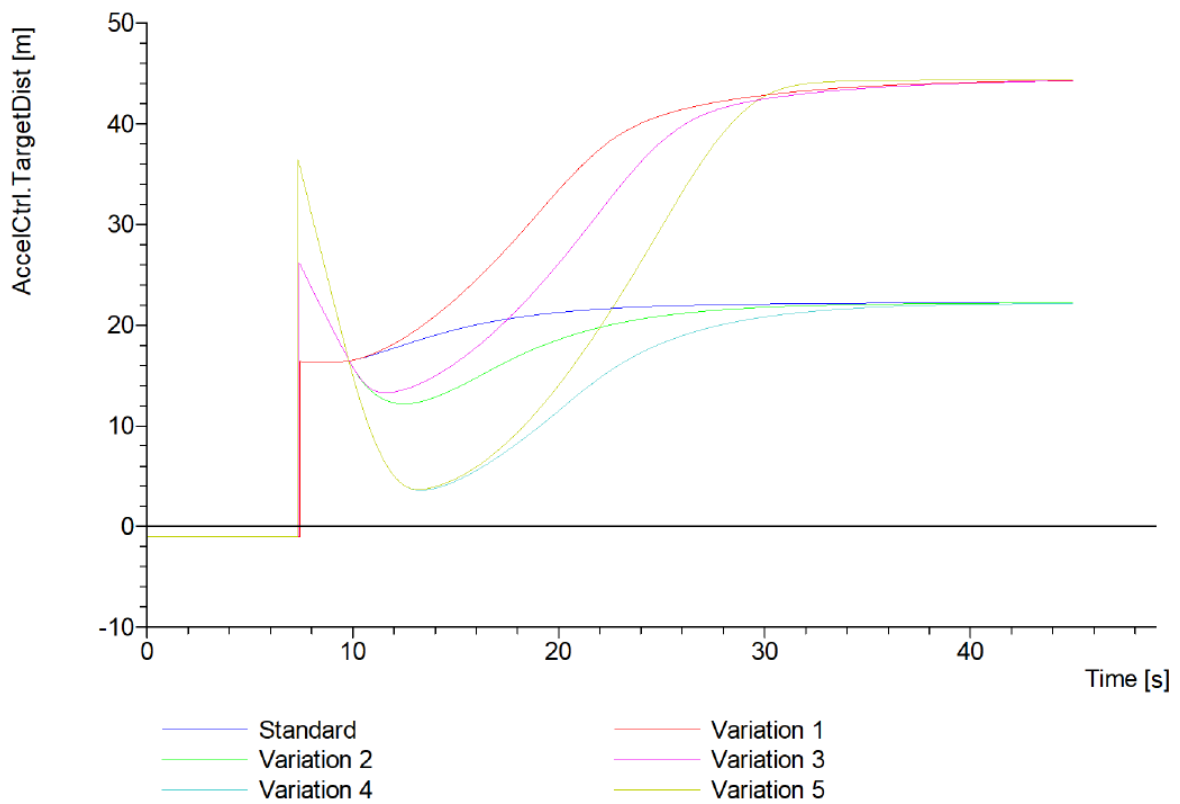

Figure 4.47: ACC-T05 AccelCtrl.TargetDist variations result graph

4.4.1.6 ACC-T06: Zhou paper – Vehicles in column: target vehicle cut-in

The goal of the test is to verify ACC action when a target vehicle cuts in the same lane of the host car. In Figure 4.48 is shown the detailed result chart presented in the CarMaker test manager report, while in the following graphs the quantities trends for each case are reported.

Detailed Results

ID	Test	Result
6	Scenarios/ACC/ACC-T06_Zhou_paper	
6.1	Standard	⚡
6.2	Variation 1	⚡
6.3	Variation 2	✅
6.4	Variation 3	⚡
6.5	Variation 4	⚡
6.6	Variation 5	✅

Figure 4.48: ACC-T06 test series detailed results

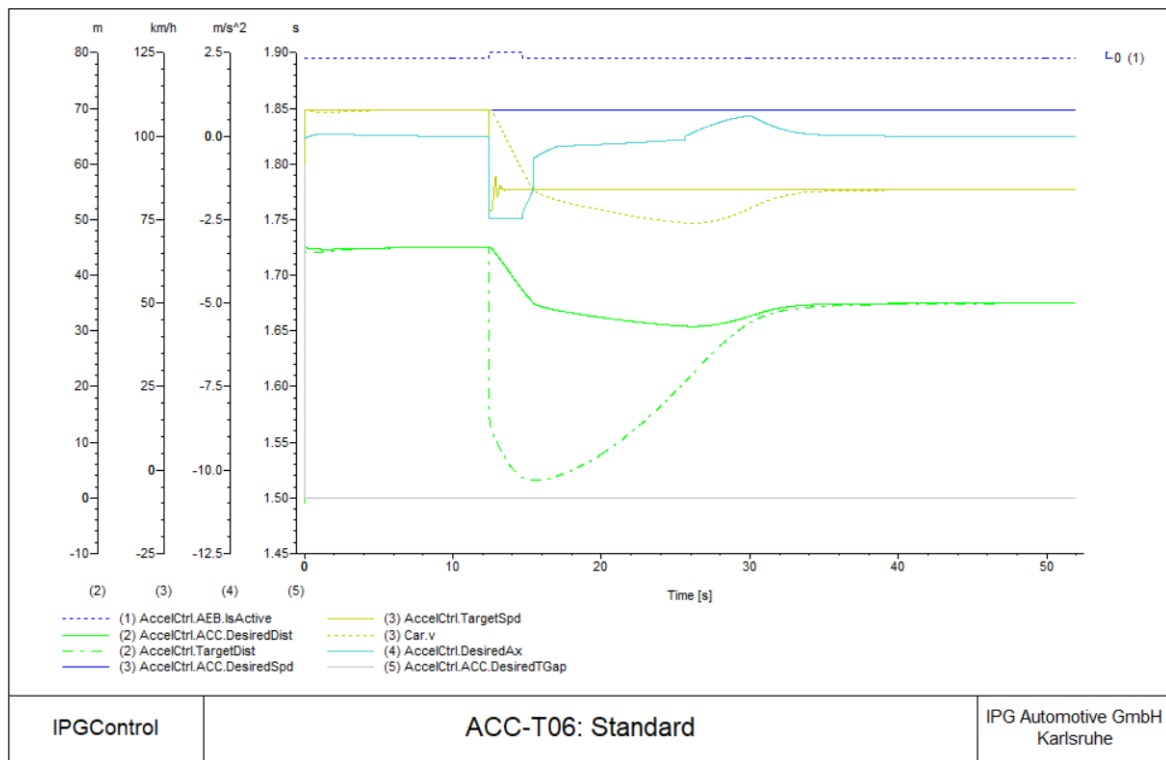
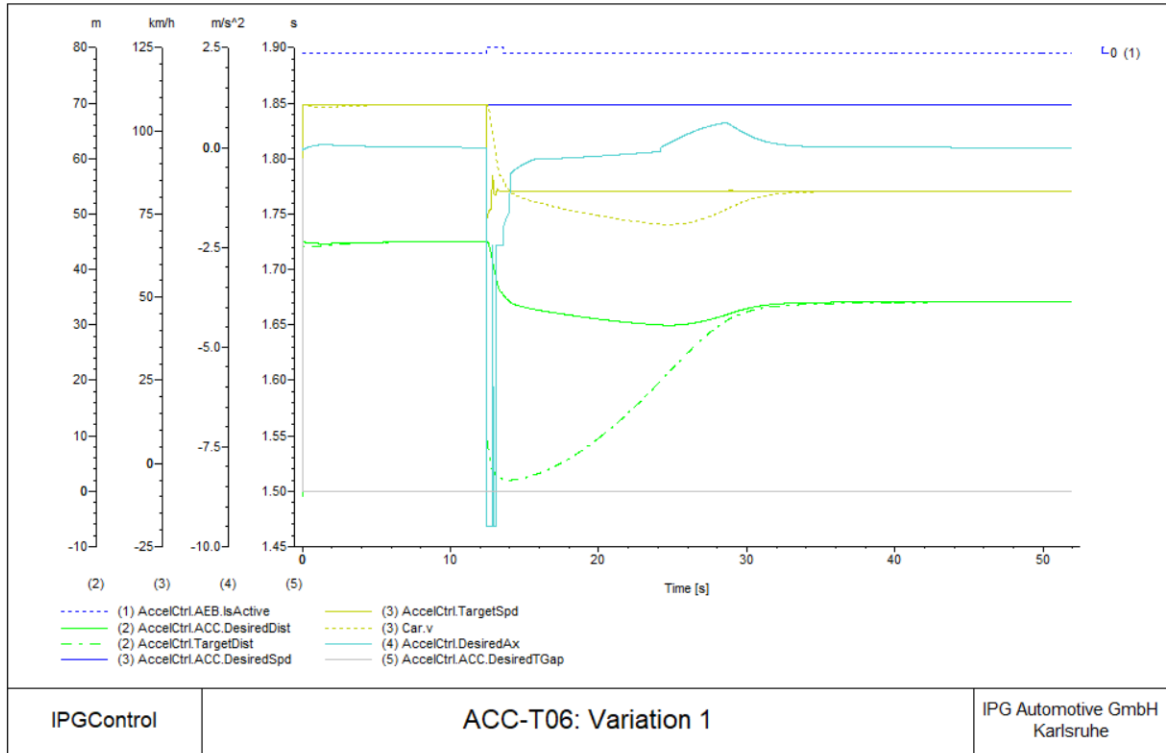
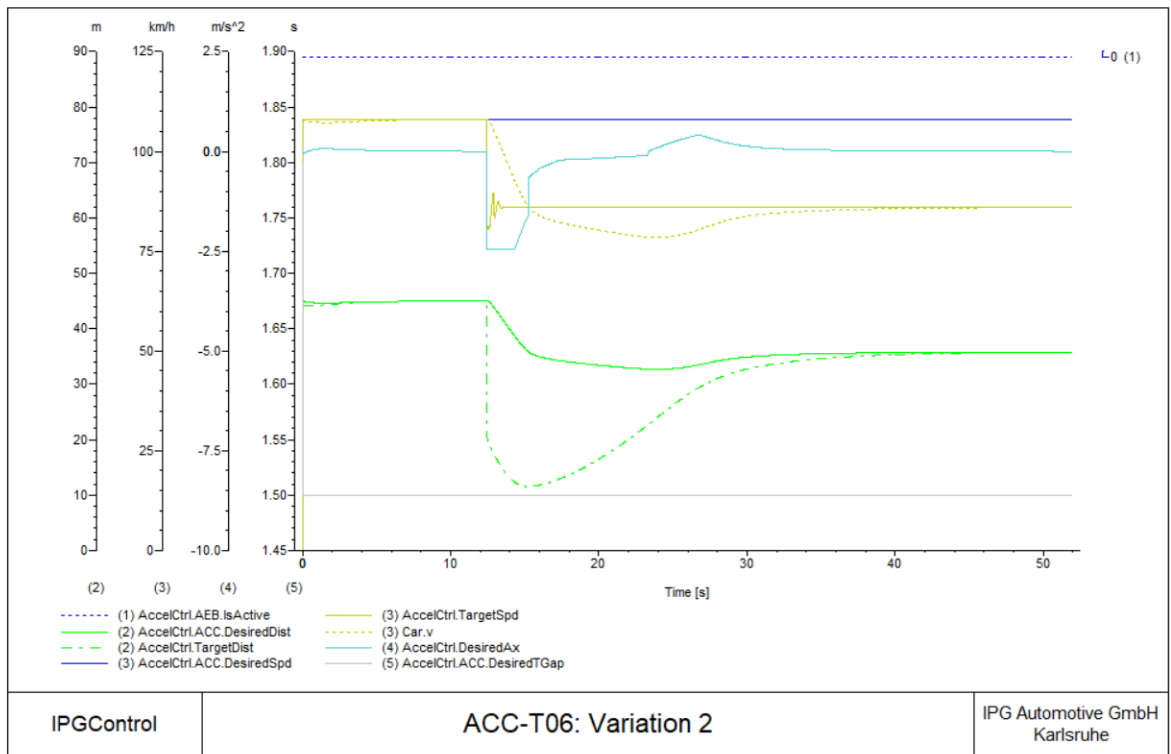

Figure 4.49: AEB-T06 Standard result graph



13.06.18 - 18:56

Figure 4.50: ACC-T06 Variation 1 result graph



13.06.18 - 18:58

Figure 4.51: ACC-T06 Variation 2 result graph

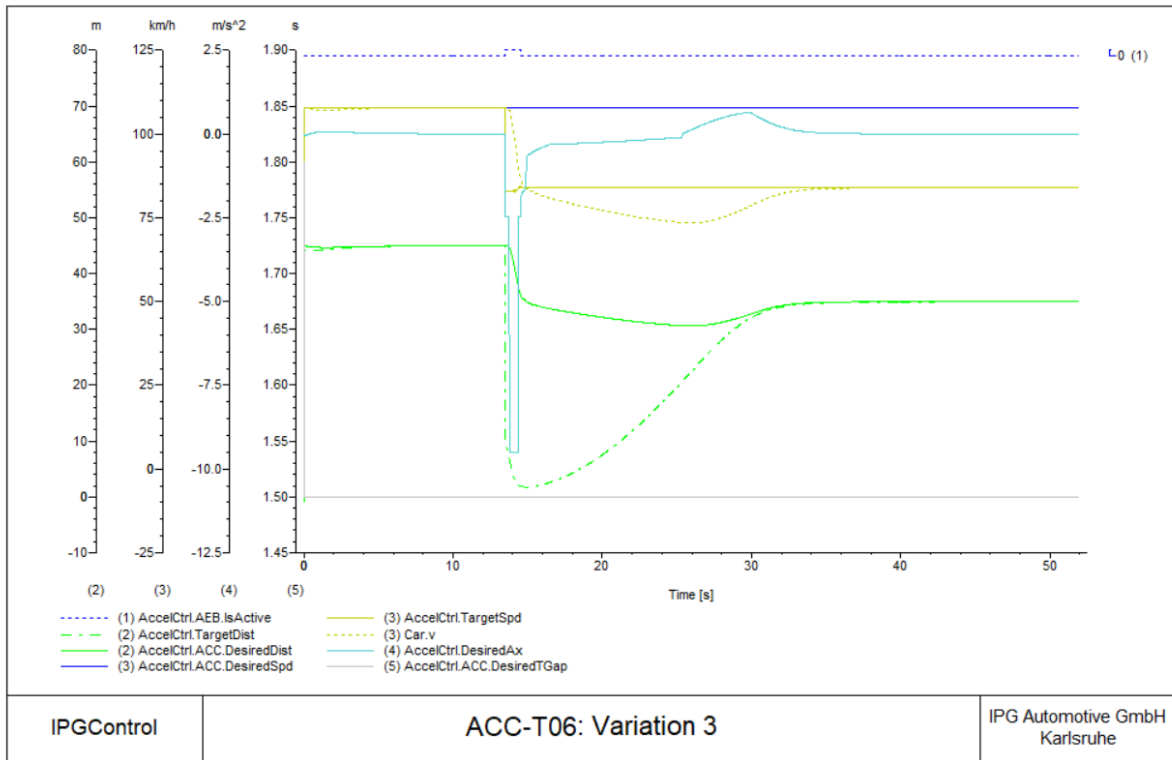

13.06.18 - 18:53

Figure 4.52: ACC-T06 Variation 3 result graph

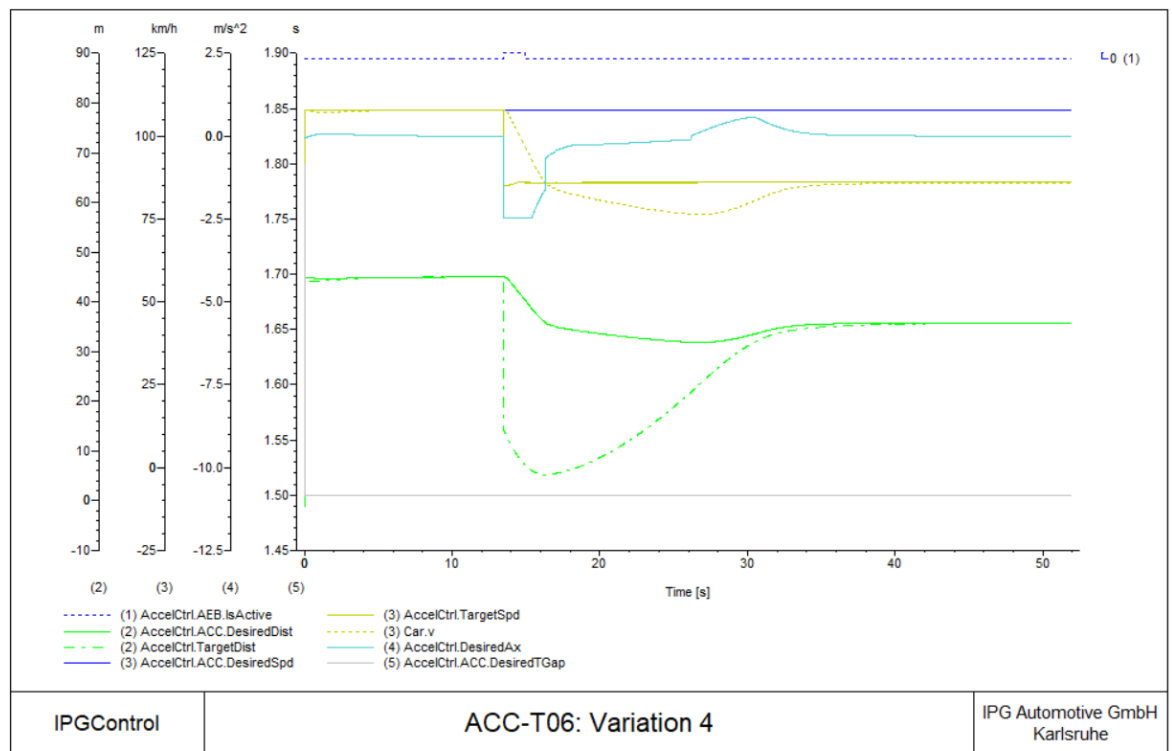

13.06.18 - 19:03

Figure 4.53: ACC-T06 Variation 4 result graph

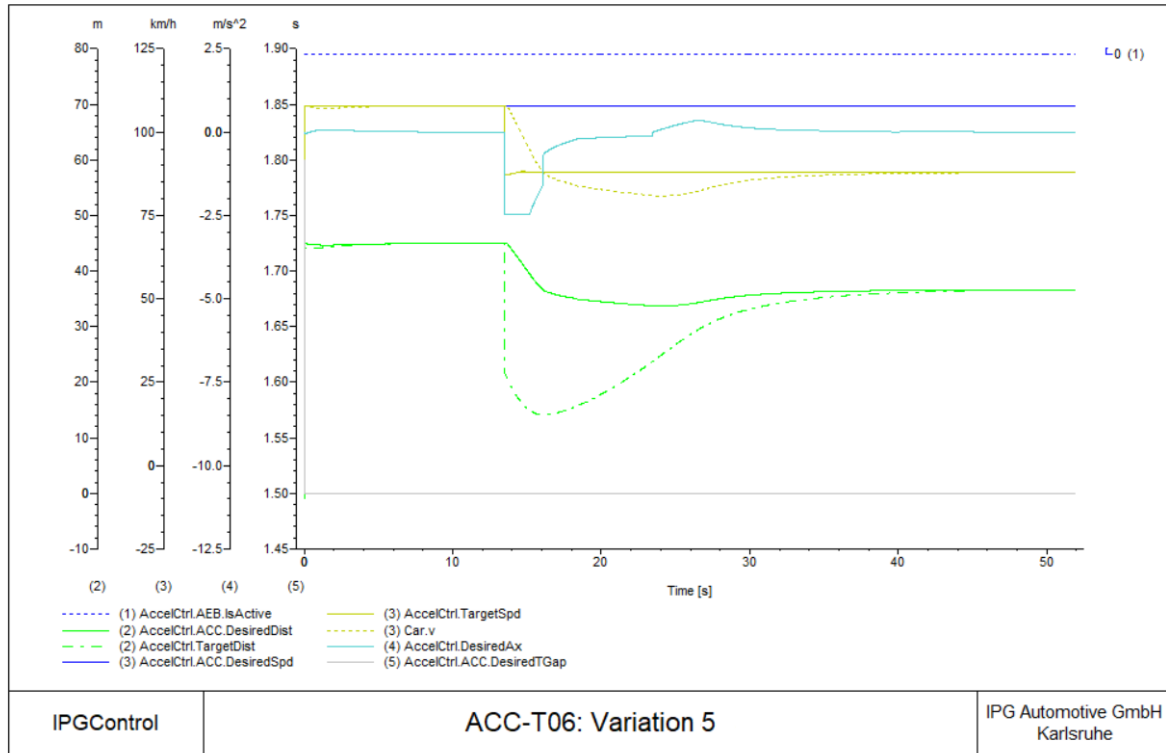

Figure 4.54: ACC-T06 Variation 5 result graph

As it is possible to see from the result chart, this test is a critic scenario, with 4 fails out of 6 variations. This is due to the low inter-vehicle distance when the ACC system detects the ahead target and by the velocity difference between the two vehicles (up to 26km/h). Indeed, decreasing too much the target vehicle velocity or the cut in distance will produce a higher deceleration request (displayed as a solid light blue line), until the AEB activation (displayed as a dotted blue line), leading to a test fail. Raising one factor but lowering the other will produce almost the same result. For this reason, the results can be analyzed in couple: Standard and Variation 4, with an emergency braking AEB activation, Variation 1 and Variation 3, with a pre-brake AEB activation, Variation 2 and Variation 5, with no AEB activation. In all cases it is possible to see how the inter-vehicle distance and host car velocity (green and yellow dotted line respectively) tend to reach and follow the desired distance and the target vehicle velocity (green and yellow solid line respectively) after the target vehicle has cut in. The desired speed, displayed with a solid blue line, has a higher value, and so the logic is performing a distance control action. To better understand the difference between the various variations, AccelCtrl.DesiredAx and AccelCtrl.TargetDist quantities are reported in Figure 4.55 and Figure 4.56, showing their trend during each test case. The two graphs reproduce the behavior of the previous diagrams, showing that decreasing the cut in distance as well as the target vehicle velocity will produce a lower inter-vehicle distance minimum peak, and, consequently, to a higher deceleration request in order to avoid a collision.

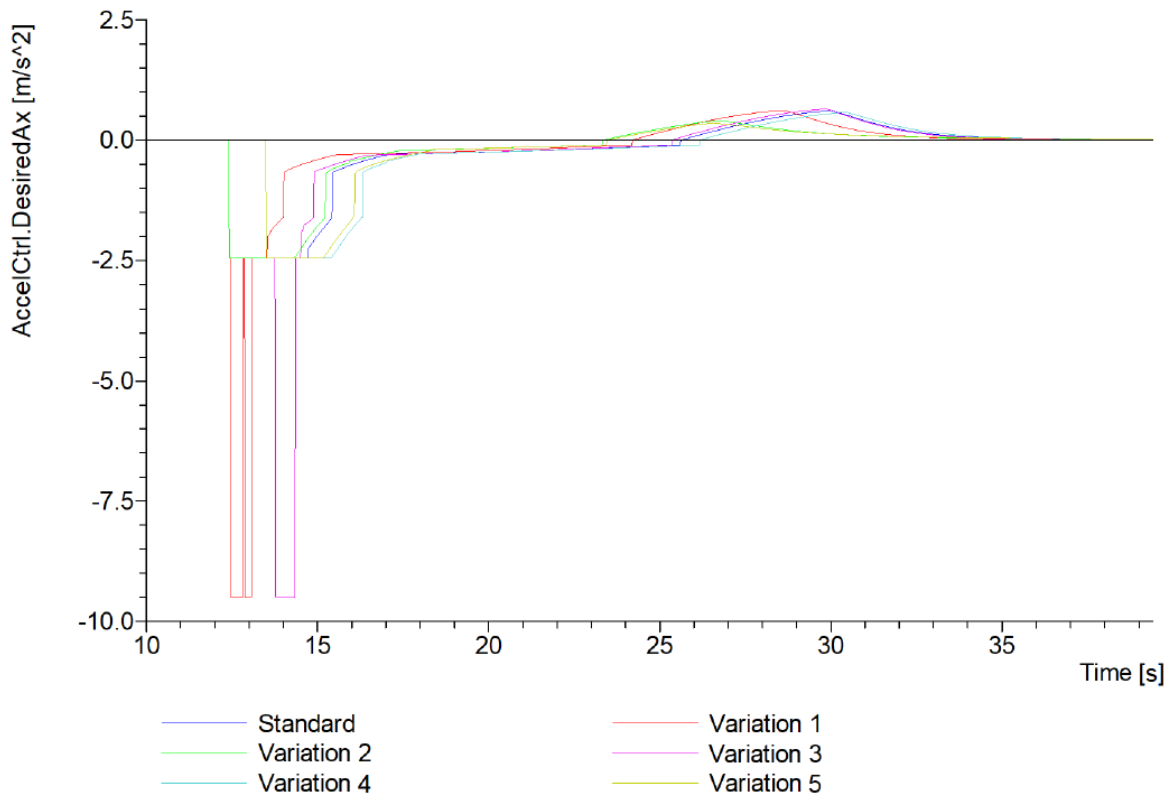

Figure 4.55: ACC-T06 AccelCtrl.DesiredAx variations result graph

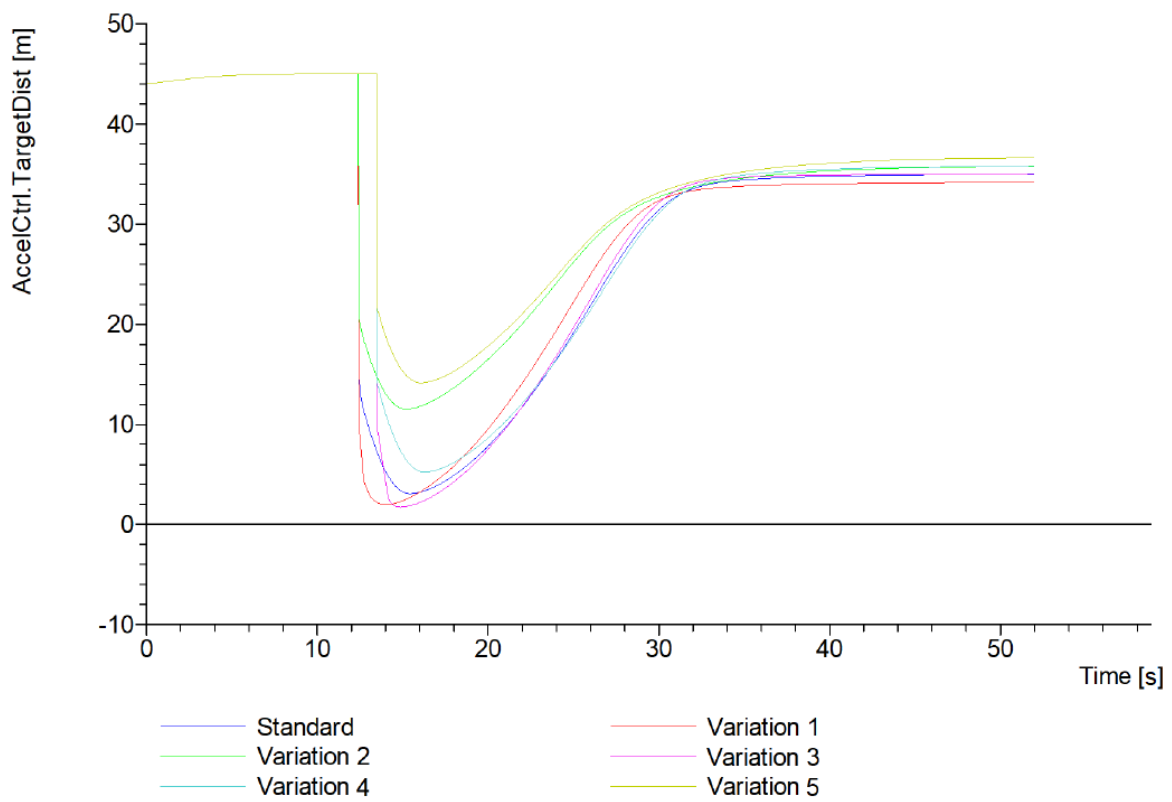

Figure 4.56: ACC-T06 AccelCtrl.TargetDist variations result graph

4.4.1.7 ACC-T07: Custom – Lane change and cruise speed test

The goal of the test is to verify ACC action when a slower vehicle is detected after the VUT driver decides to change lane, but also to prove that the system cannot exceed the host vehicle desired speed. In Figure 4.57 is shown the detailed result chart presented in the CarMaker test manager report, while in the following graphs the quantities trends for each case are reported.

Detailed Results

ID	Test	Result
7	Scenarios/ACC/ACC-T07_Custom	
7.1	Standard	✓
7.2	Variation 1	✓
7.3	Variation 2	✓
7.4	Variation 3	✓
7.5	Variation 4	⚡
7.6	Variation 5	⚡

Figure 4.57: ACC-T07 test series detailed results

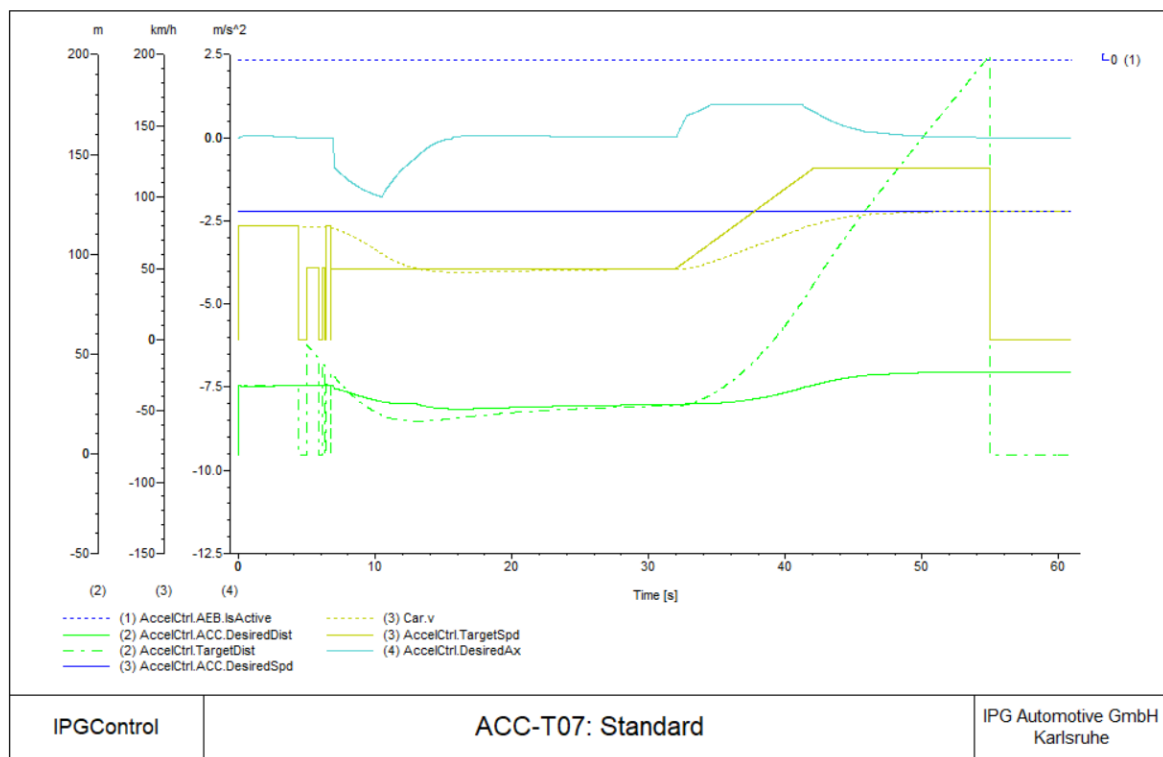
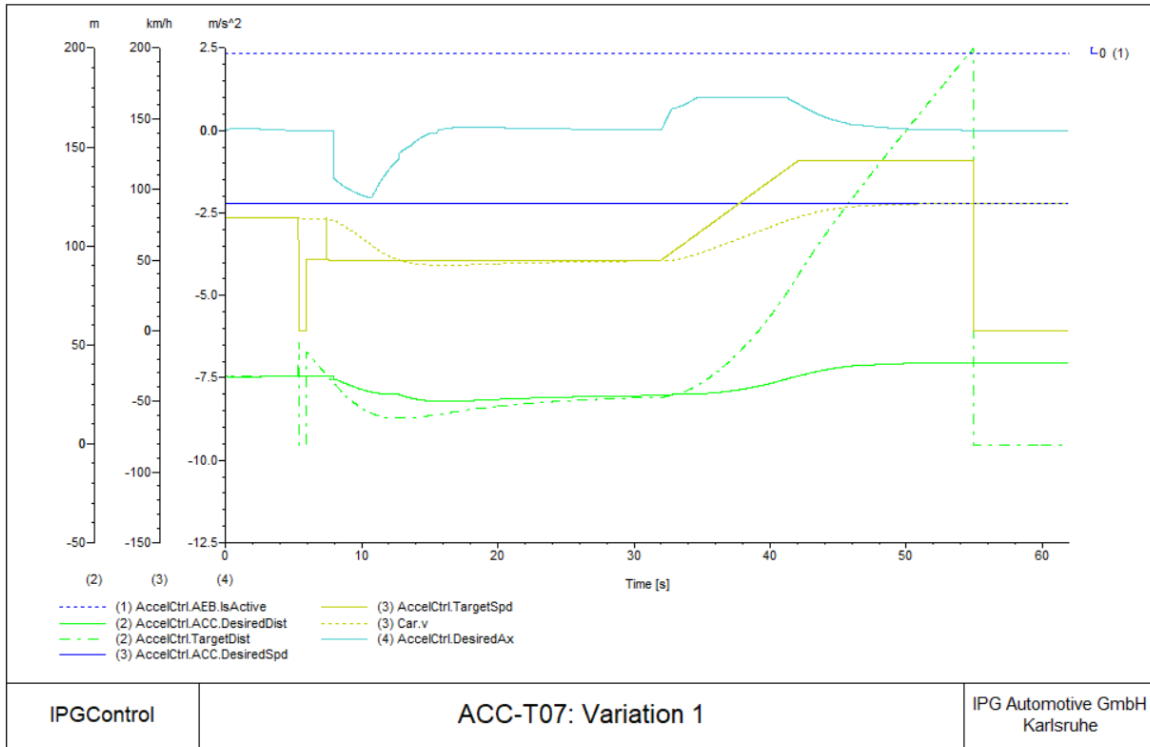
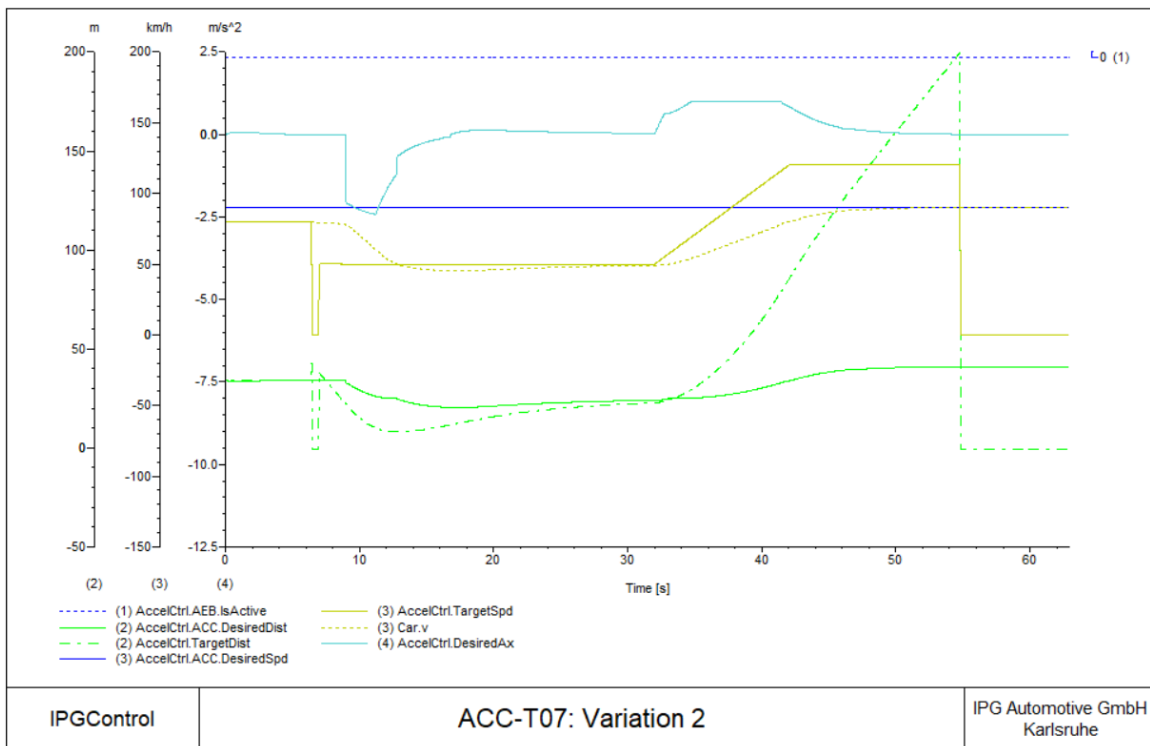

Figure 4.58: AEB-T07 Standard result graph



14.06.18 - 11:24

Figure 4.59: ACC-T07 Variation 1 result graph



14.06.18 - 11:26

Figure 4.60: ACC-T07 Variation 2 result graph

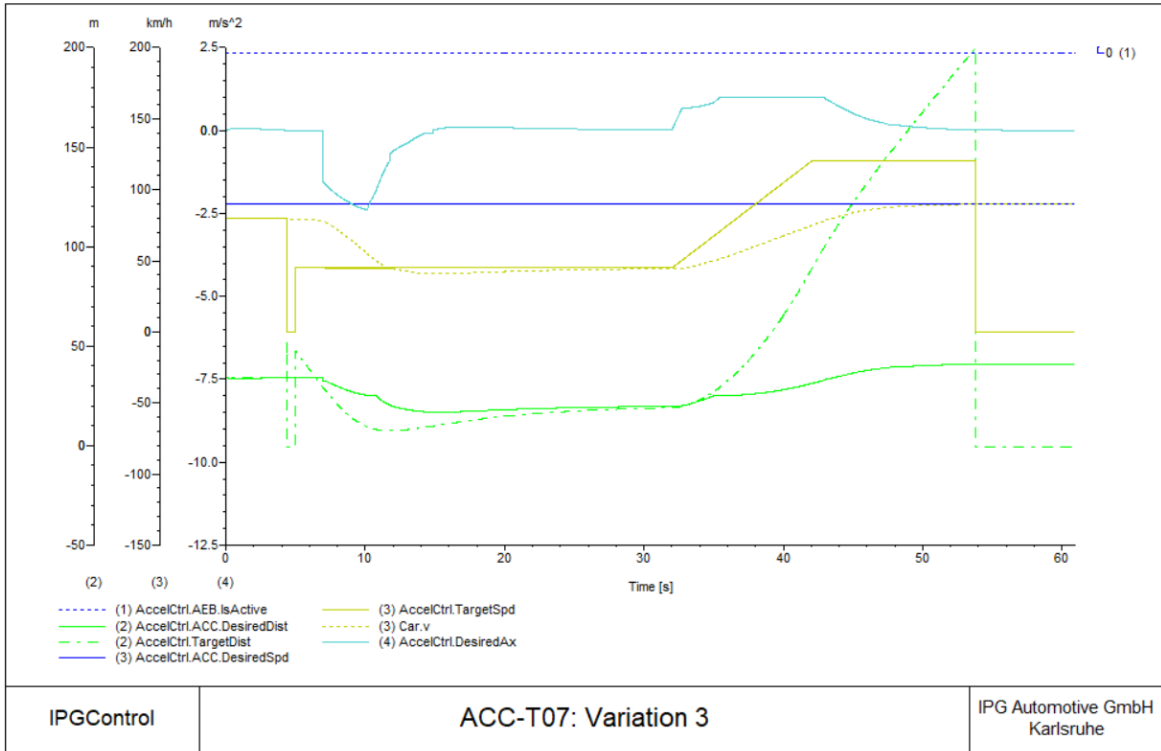

Figure 4.61: ACC-T07 Variation 3 result graph

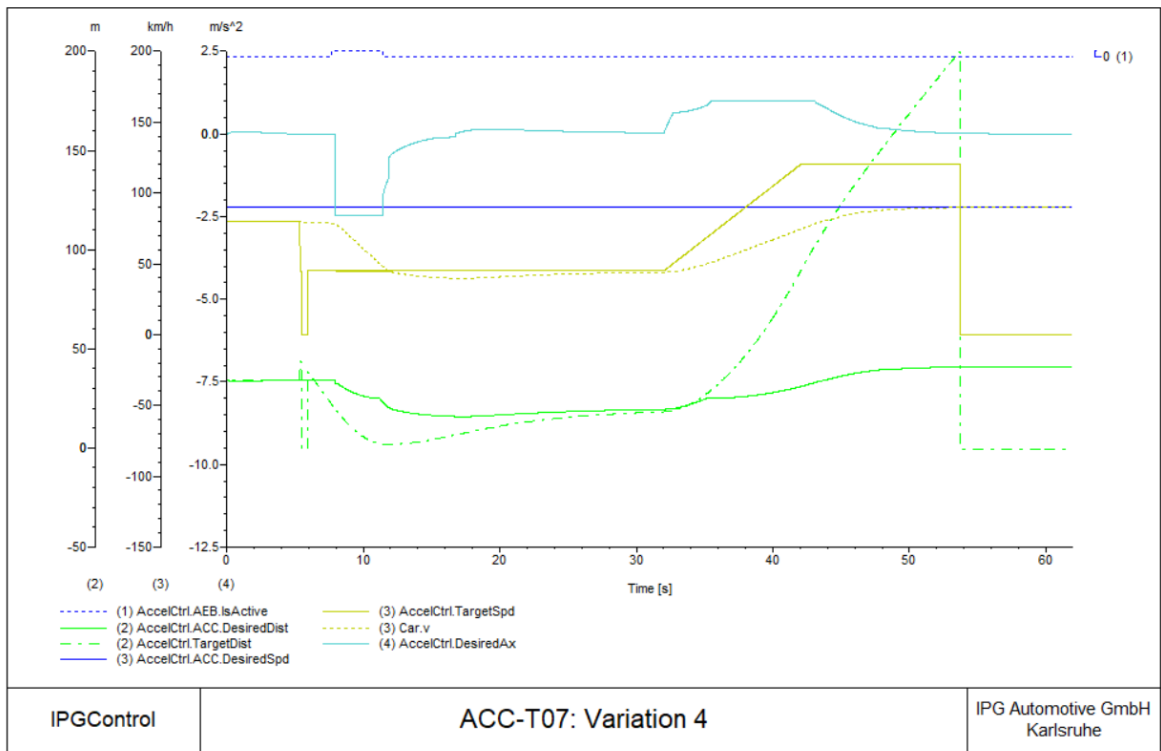

Figure 4.62: ACC-T07 Variation 4 result graph

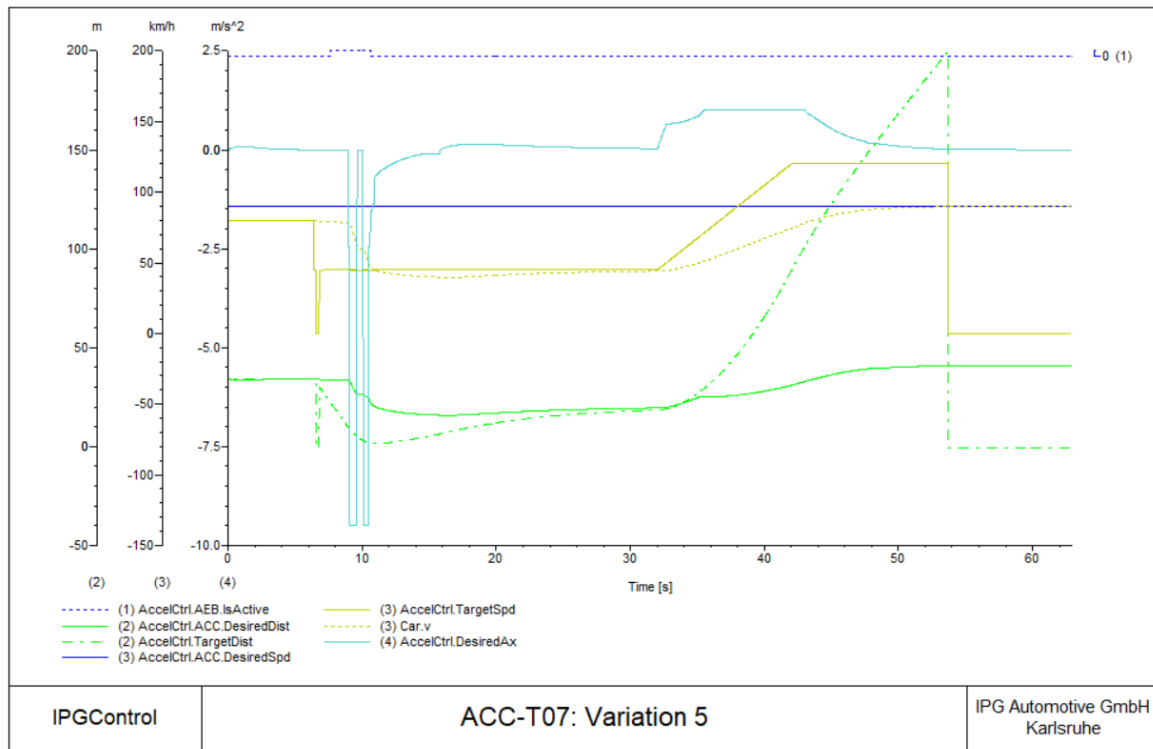

Figure 4.63: ACC-T07 Variation 5 result graph

As it is possible to see, decreasing the target vehicle velocity or the cut in distance will produce a higher deceleration request (displayed as a solid light blue line), until the AEB activates (displayed as a dotted blue line), leading to a test fail. In Standard, Variation 1, 2 and 3 the ACC was still capable of managing the situation. In Variation 4 the AEB pre-brake system activated, while in Variation 5 the full brake force was necessary in order to avoid a collision. In all cases it is possible to see how around 6 seconds (when the host car changes lane), the sensor loses the target when it has to switch vehicle, leading to a negative peak in the inter-vehicle distance and in the target car velocity (dotted green and solid yellow line respectively). Even when the sensor has acquired the new target, the ACC system did not intervene until the driver had finished to steer. After that, the actual inter-vehicle distance is lower than the security one, leading to a brake request. The system is firstly controlled by the distance logic, trying to reach and follow the desired distance and the target vehicle velocity (green and yellow solid line respectively), but when the target vehicle accelerates over the desired speed (solid blue line), the system logic is switched to a velocity control action, saturating the host car speed. To better understand the difference between the various variations, AccelCtrl.DesiredAx and AccelCtrl.TargetDist quantities are reported in Figure 4.64 and Figure 4.65, showing their trend during each test case. The two graphs reproduce the behavior of the previous diagrams, showing that increasing the cut in distance, the brake request is performed later, leading Variation 4 and 5 to an AEB activation. The same is happening when decreasing the host vehicle velocity, with the distance between the two vehicles reducing quicker, as the deceleration request is higher, bringing to a lower minimum peak before raising seeking to reach the desired inter-vehicle distance. In the final part of the two graphs it is possible to see how an acceleration request is performed until suitable, while the target vehicle, faster, disappears from radar range.

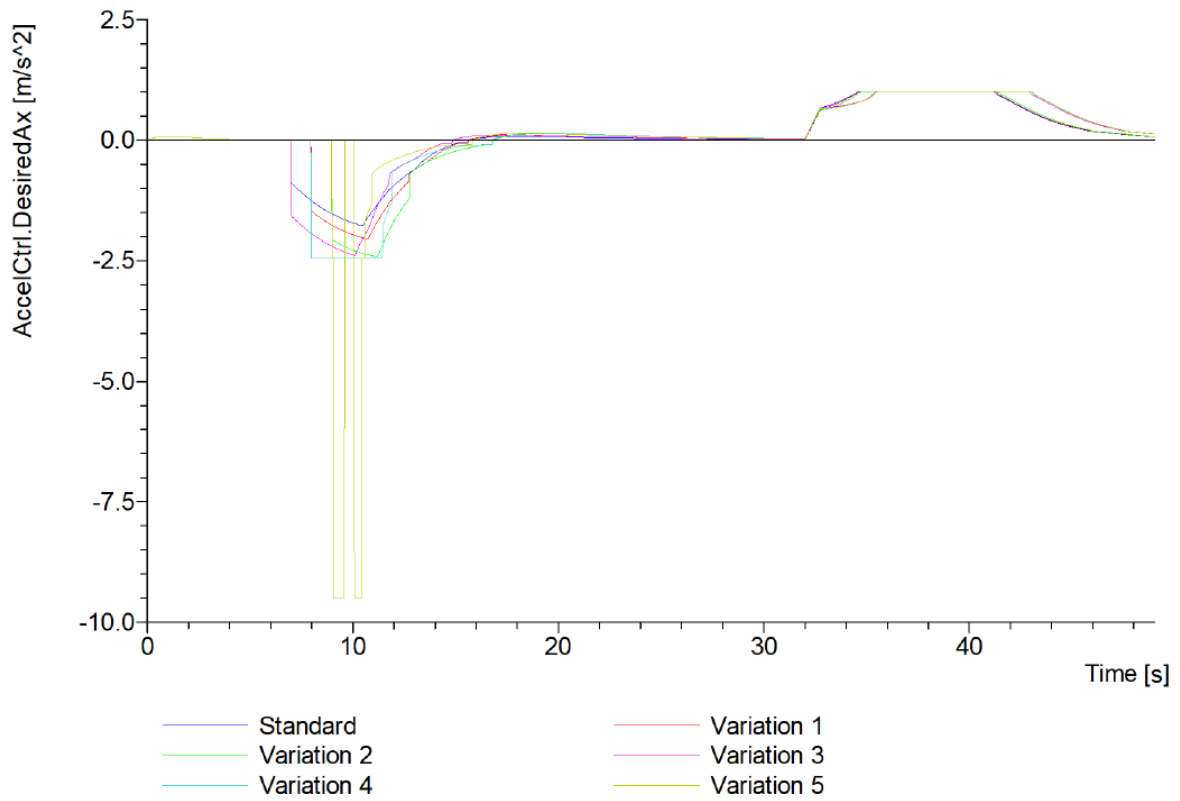

Figure 4.64: ACC-T07 `AccelCtrl.DesiredAx` variations result graph

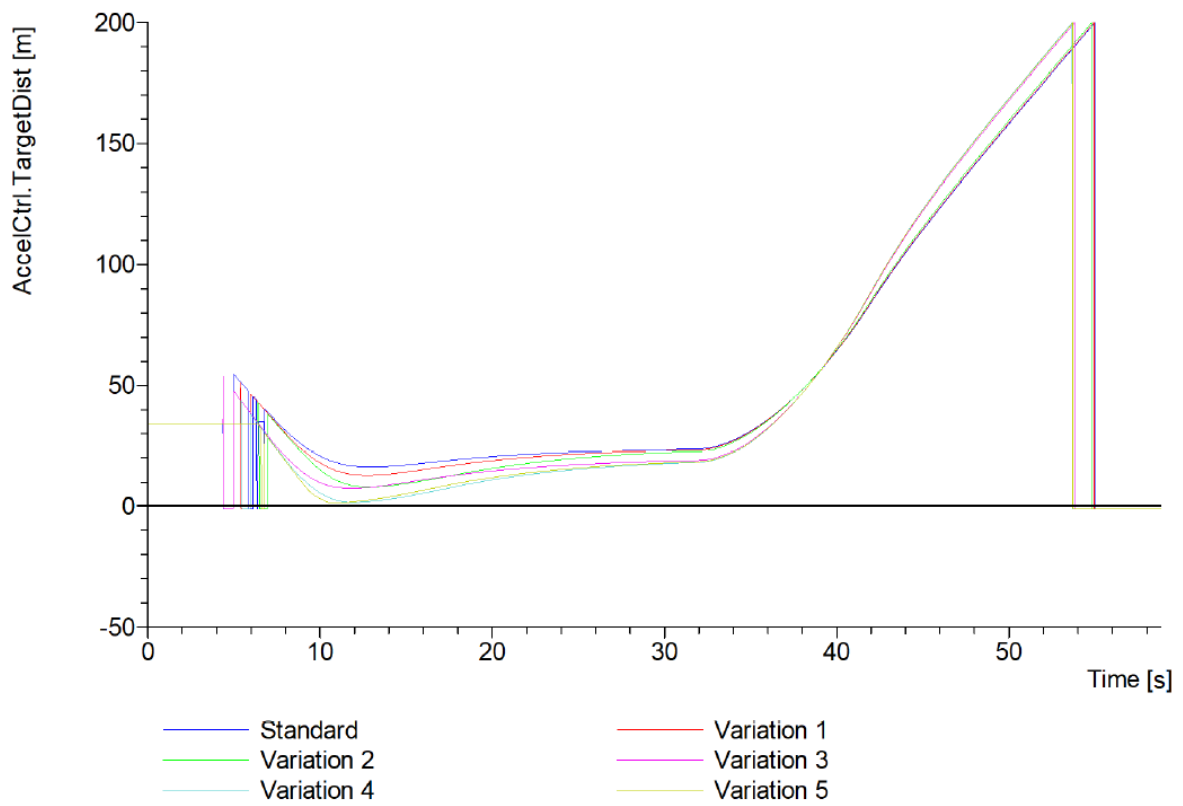

Figure 4.65: ACC-T07 `AccelCtrl.TargetDist` variations result graph

4.4.2 AEB

The criteria used for evaluating the AEB scenarios is the following:

- If the host car doesn't collide with the target vehicle, it is considered a pass (green mark).
- If the host car collides with the target vehicle, it is considered a fail (red mark).
- If the host car doesn't collide with the target vehicle, but the minimum inter-vehicle distance reached is under a threshold (set at 1.3 m), it is considered a pass with warning (yellow mark).

The overall results chart is presented in Figure 4.66, where the total number of properly passed, passed with warning and failed test, as well as their percentage, is reported. All the AEB test series scenarios were created into a single file called "AEB_scenarios.ts" with a total simulation time at full speed of 5min 38s.

Overall Results

Number of Tests:	68	100.0 %	
Tests passed:	43	63.2 %	✓
Tests skipped:	0	0.0 %	⏸
Tests with warning:	11	16.2 %	⚠
Tests failed:	14	20.6 %	✗
Tests with error:	0	0.0 %	⚡
Tests not executed:	0	0.0 %	○

Figure 4.66: AEB scenarios overall results chart

4.4.2.1 AEB-T01: EuroNCAP CCRs – Approaching a stationary vehicle

The goal of the test is to verify AEB action when the host car approaches a stopped vehicle. In Figure 4.67 is shown the detailed result chart presented in the CarMaker test manager report, while in the following graphs the quantities trends for each case are reported.

Detailed Results

ID	Test	Result	
		$C_f = 1$	$C_f = 0.5$
1	Scenarios/AEB/AEB-T01_EuroNCAP_CCRs		
1.1	Standard 1	✓	✓
1.2	Standard 2	✓	✓
1.3	Standard 3	✓	⚠
1.4	Standard 4	✓	✗
1.5	Standard 5	✓	✗
1.6	Standard 6	⚠	✗

Figure 4.67: AEB-T01 test series detailed results

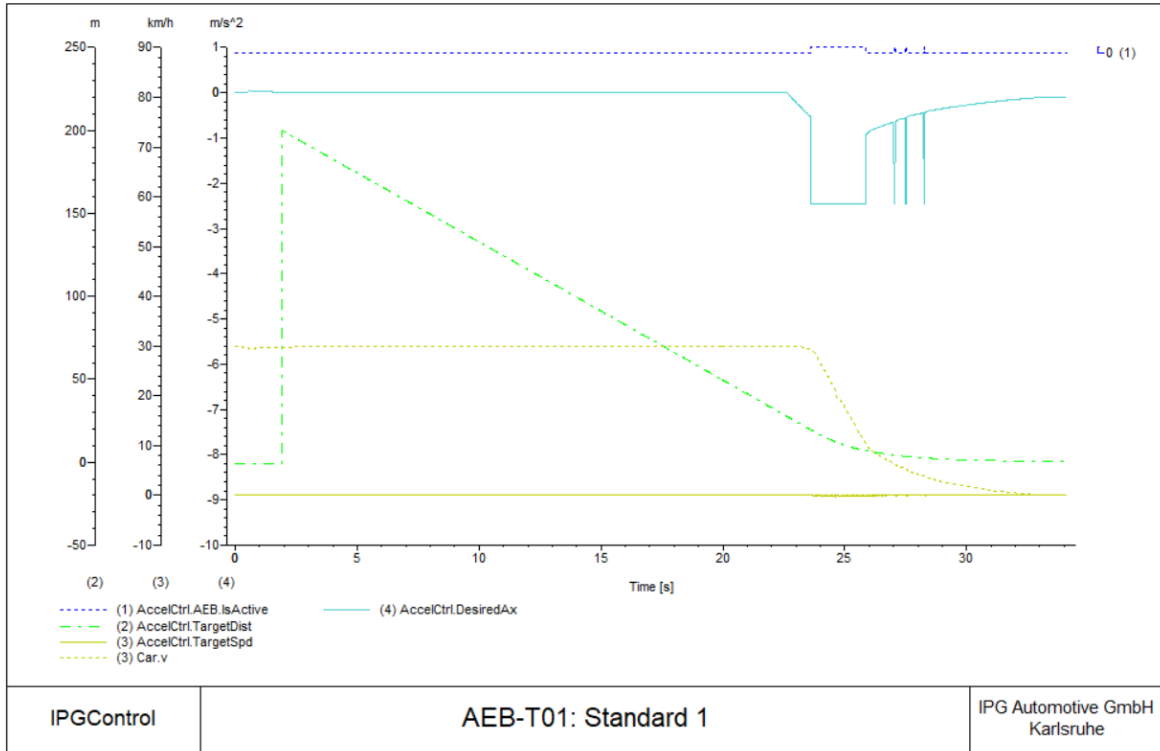

14.06.18 - 19:47

Figure 4.68: AEB-T01 Standard 1 result graph

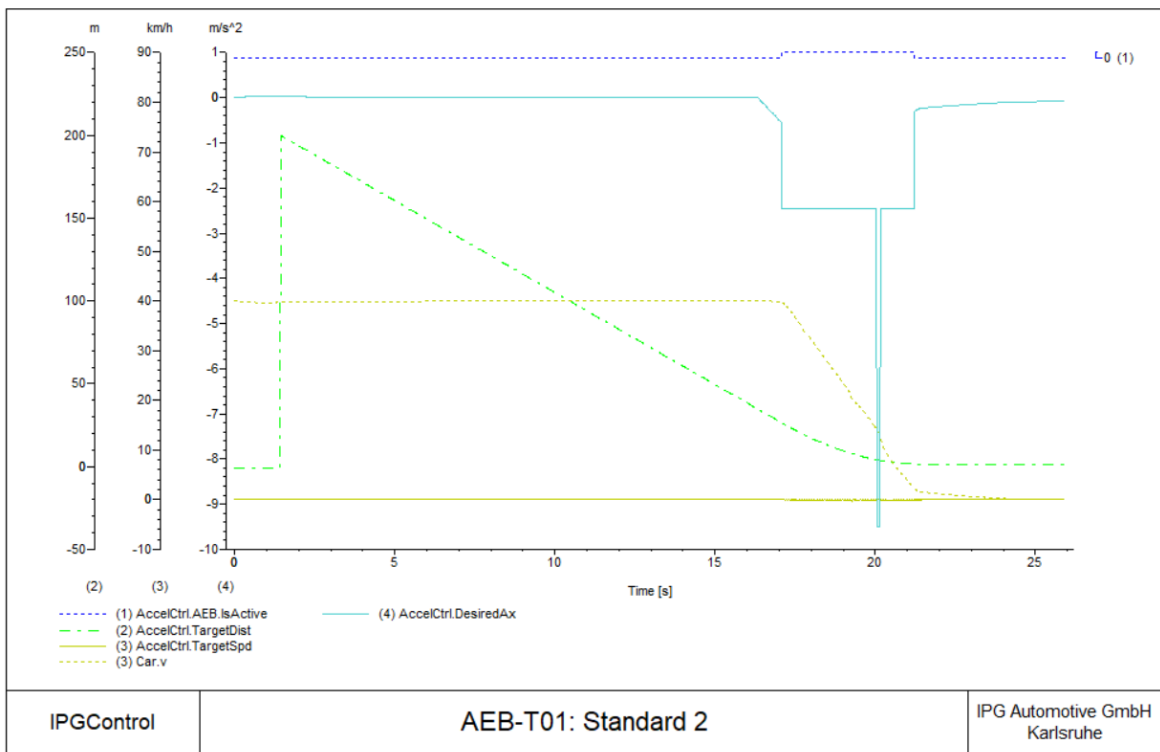

14.06.18 - 20:08

Figure 4.69: AEB-T01 Standard 2 result graph

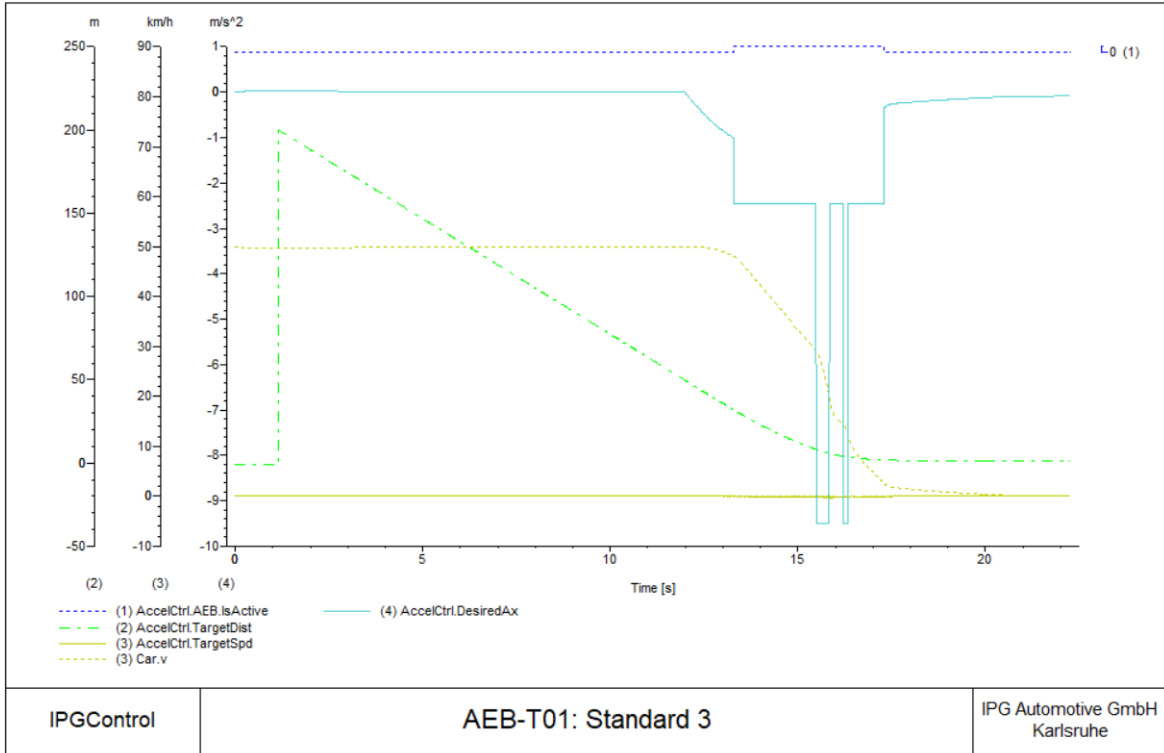

14.06.18 - 20.01

Figure 4.70: AEB-T01 Standard 3 result graph

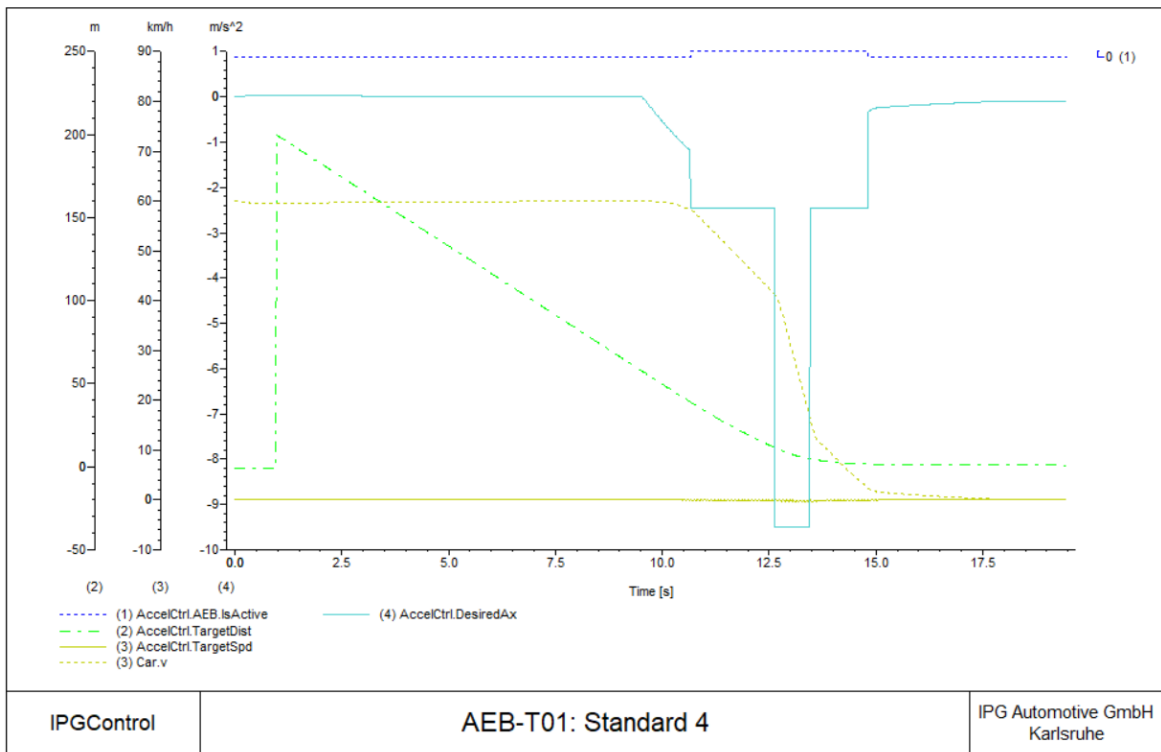

14.06.18 - 20.03

Figure 4.71: AEB-T01 Standard 4 result graph

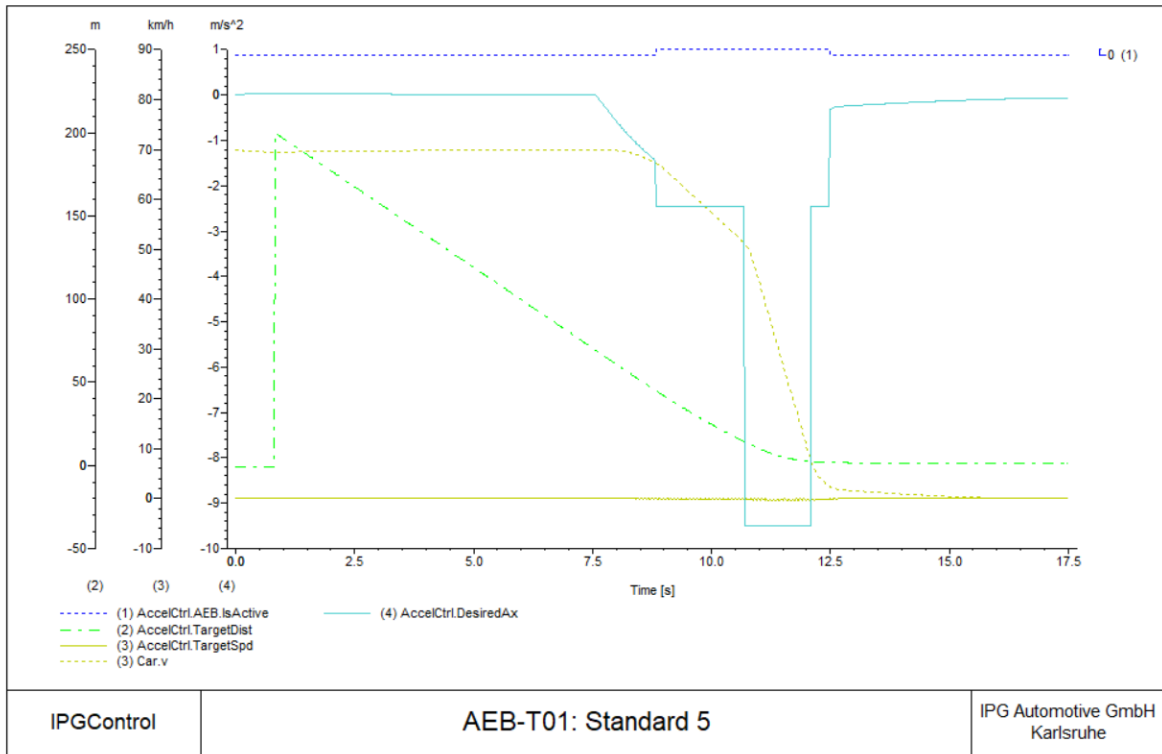

14.06.18 - 20:05

Figure 4.72: AEB-T01 Standard 5 result graph

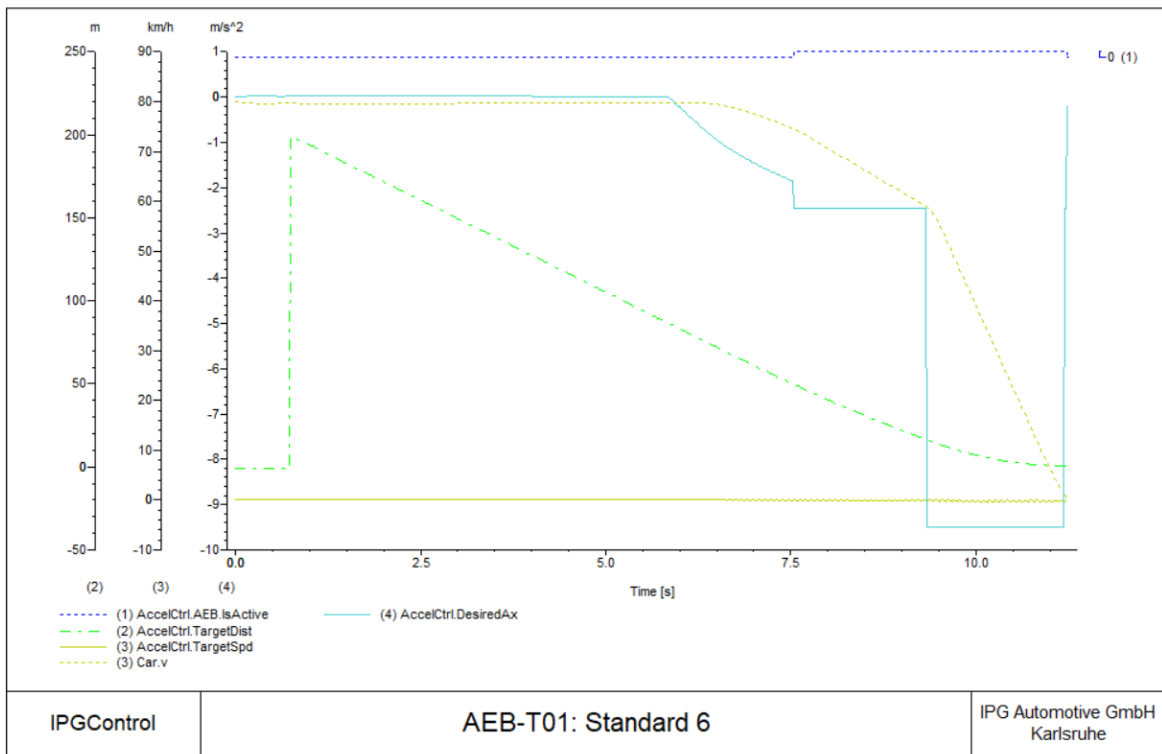

14.06.18 - 19:48

Figure 4.73: AEB-T01 Standard 6 result graph

As it is possible to see, increasing the host vehicle velocity will produce a higher deceleration request (displayed as a solid light blue line), until the AEB activation (displayed as a dotted blue line). In the Standard 1 test, the pre-brake action was sufficient to avoid a vehicle collision, while in the others tests the full brake is activated, longer with higher speeds.

In all cases it is possible to see how when the sensor range is reached, the target vehicle is detected (with its speed reported as a solid yellow line), but the host car continues to travel at its speed (dotted yellow line) because too far. When the VUT moves closer to the target vehicle, the ACC system intervenes, but, as soon as the TTC thresholds are reached, the pre-brake and the full brake AEB actions are performed.

To better understand the difference between the various variations, AccelCtrl.DesiredAx and AccelCtrl.TargetDist quantities are reported in Figure 4.74 and Figure 4.75, showing their trend during each test case. The two graphs reproduce the behavior of the previous diagrams, showing that increasing the host car velocity, the VUT will reach the target vehicle position earlier and with a higher deceleration request, so that the inter-vehicle distance is reduced quicker. In dry road conditions ($C_f = 1$) all the test ends successfully, except for Standard 6 test, where a minimum inter-vehicle distance of 0.5m has been reached, leading to a warning.

The same test series were also reproduced with a lower friction coefficient ($C_f = 0.5$) simulating a wet road, which AccelCtrl.DesiredAx variations are shown in Figure 4.76. In this case, a warning is already present in the Standard 3 test, where a minimum inter-vehicle distance of 1.2m has been reached. While Standard 1 and 2 tests are still passed successfully, Standard 4, 5 and 6 scenarios failed due to the presence of a collision, as it is possible to see from the corresponding interrupted lines. However, the impact speed was still decreased to 17.3 km/h, 30.1 km/h and 38.1 km/h, so with an initial speed reduction of 71.2%, 57% and 52.4% respectively.

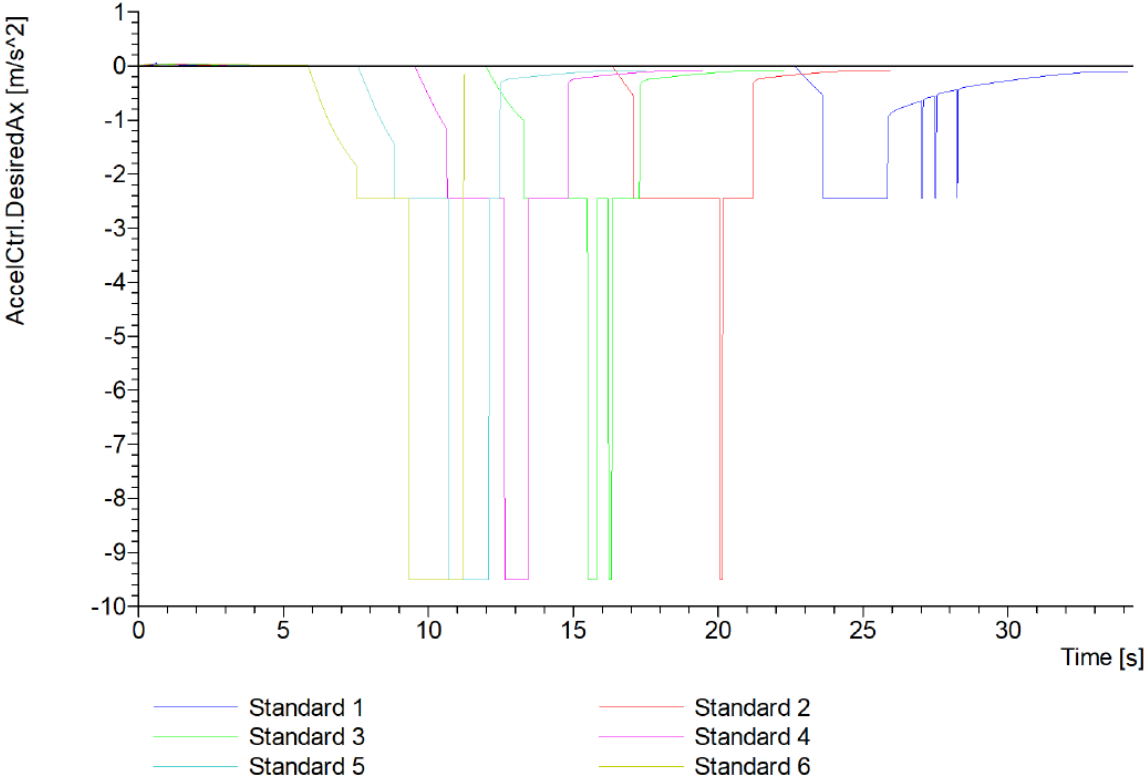

Figure 4.74: AEB-T01 AccelCtrl.DesiredAx variations result graph with $C_f=1$

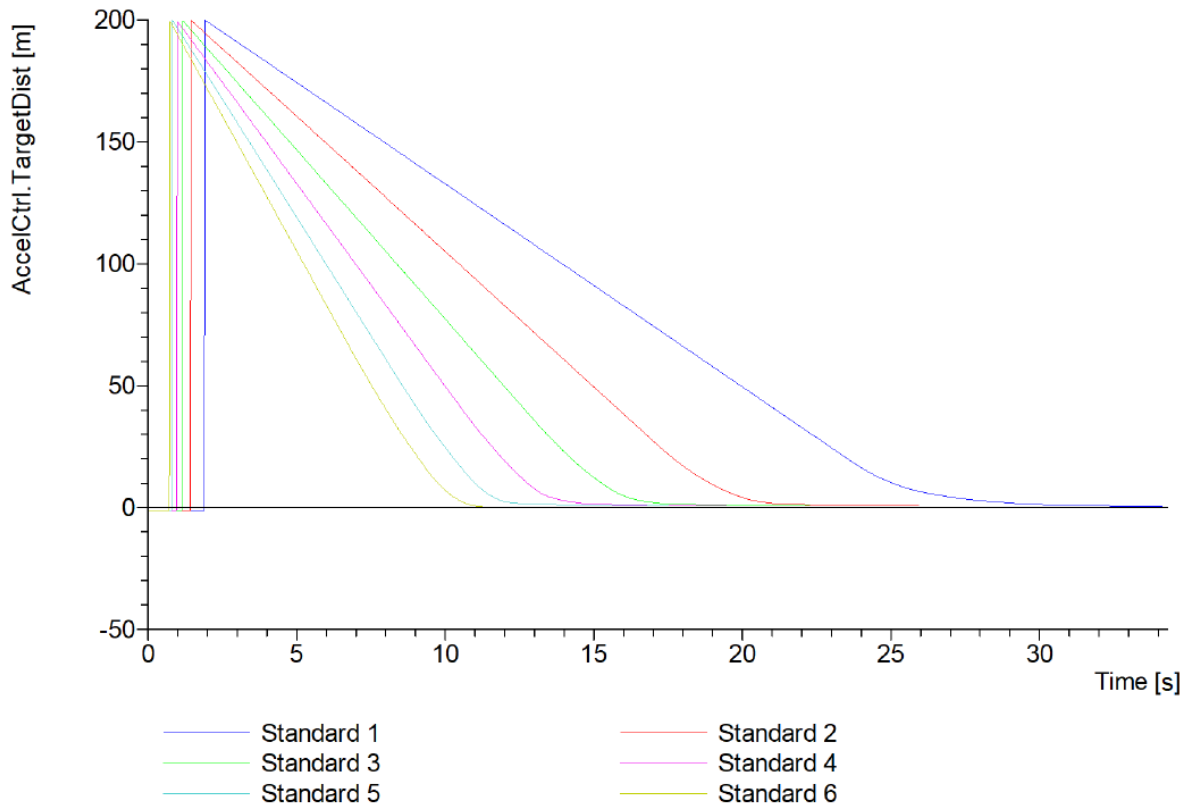

Figure 4.75: AEB-T01 AccelCtrl.TargetDist variations result graph with Cf=1

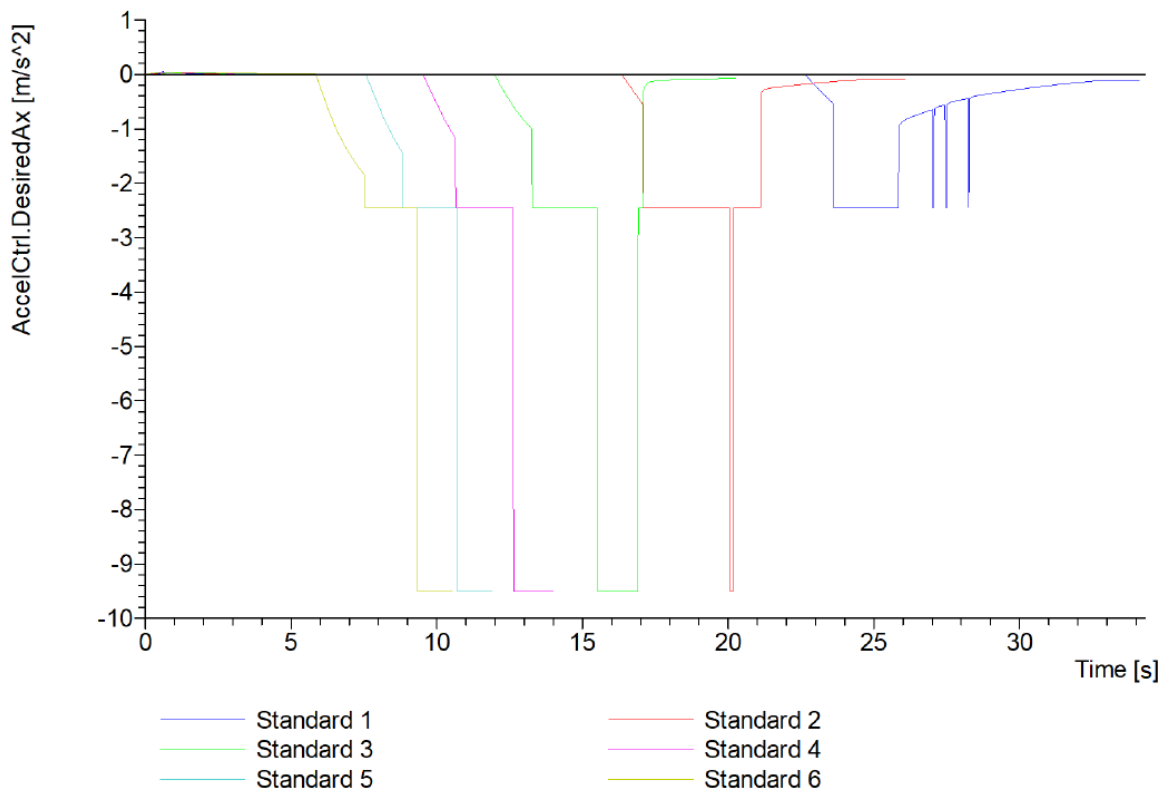

Figure 4.76: AEB-T01 AccelCtrl.DesiredAx variations result graph with Cf=0.5

4.4.2.2 AEB-T02: EuroNCAP CCRm – Approaching a slower moving vehicle

The goal of the test is to verify AEB action when the host car approaches a slower moving vehicle. In Figure 4.77 is shown the detailed result chart presented in the CarMaker test manager report, while in the following graphs the quantities trends for each case are reported.

Detailed Results

ID	Test	Result	
		C _f = 1	C _f = 0.5
2	Scenarios/AEB/AEB-T02_EuroNCAP_CCRm		
2.1	Standard 1	✓	✓
2.2	Standard 2	✓	✓
2.3	Standard 3	✓	✓
2.4	Standard 4	✓	✓
2.5	Standard 5	✓	✓
2.6	Standard 6	✓	✗

Figure 4.77: AEB-T02 test series detailed results

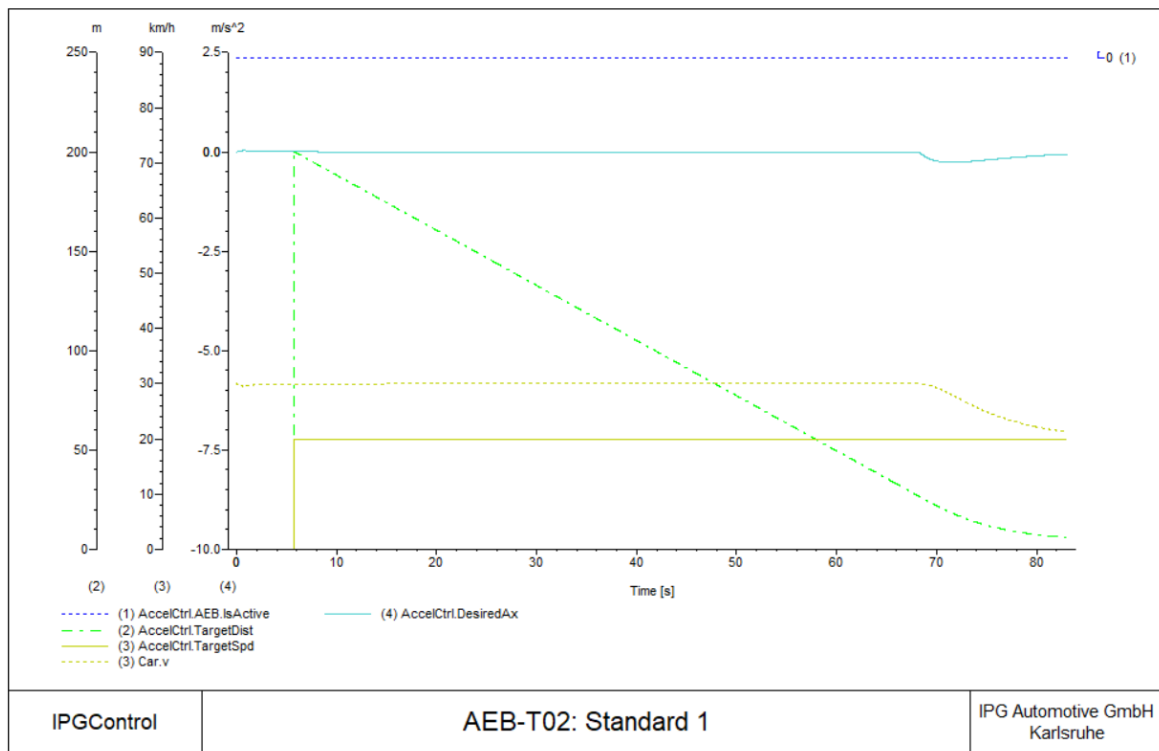
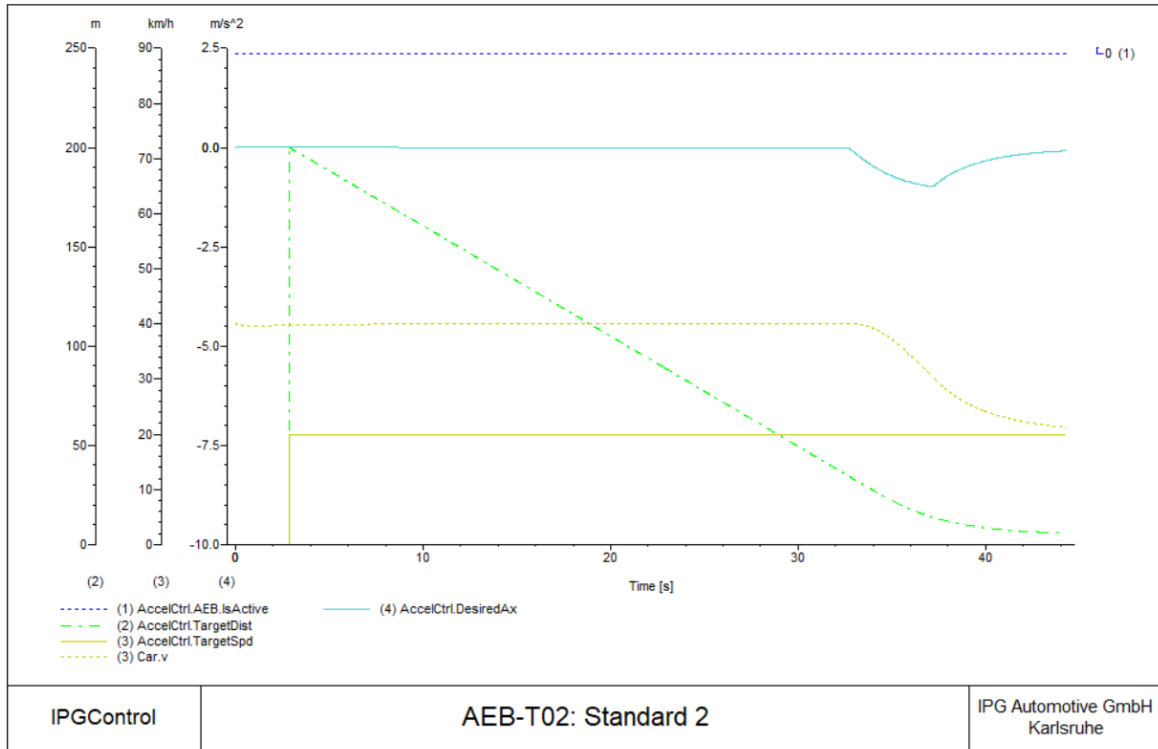
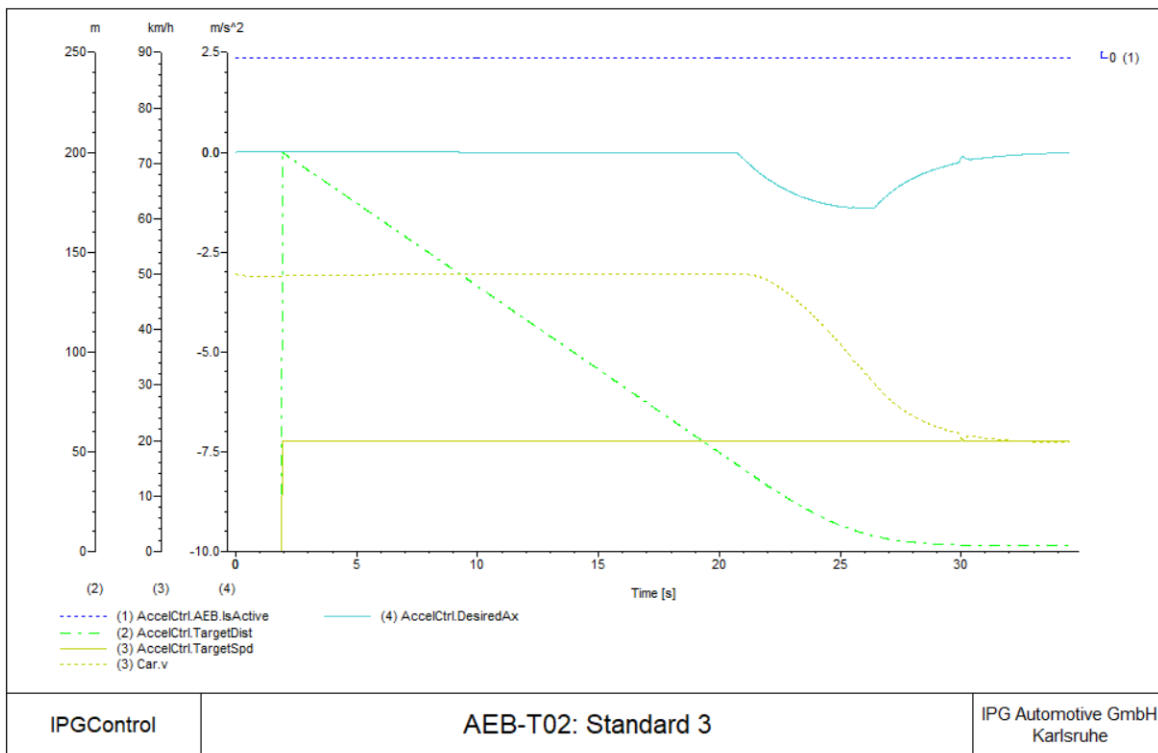

Figure 4.78: AEB-T02 Standard 1 result graph



15.06.18 - 17:47

Figure 4.79: AEB-T02 Standard 2 result graph



15.06.18 - 17:48

Figure 4.80: AEB-T02 Standard 3 result graph

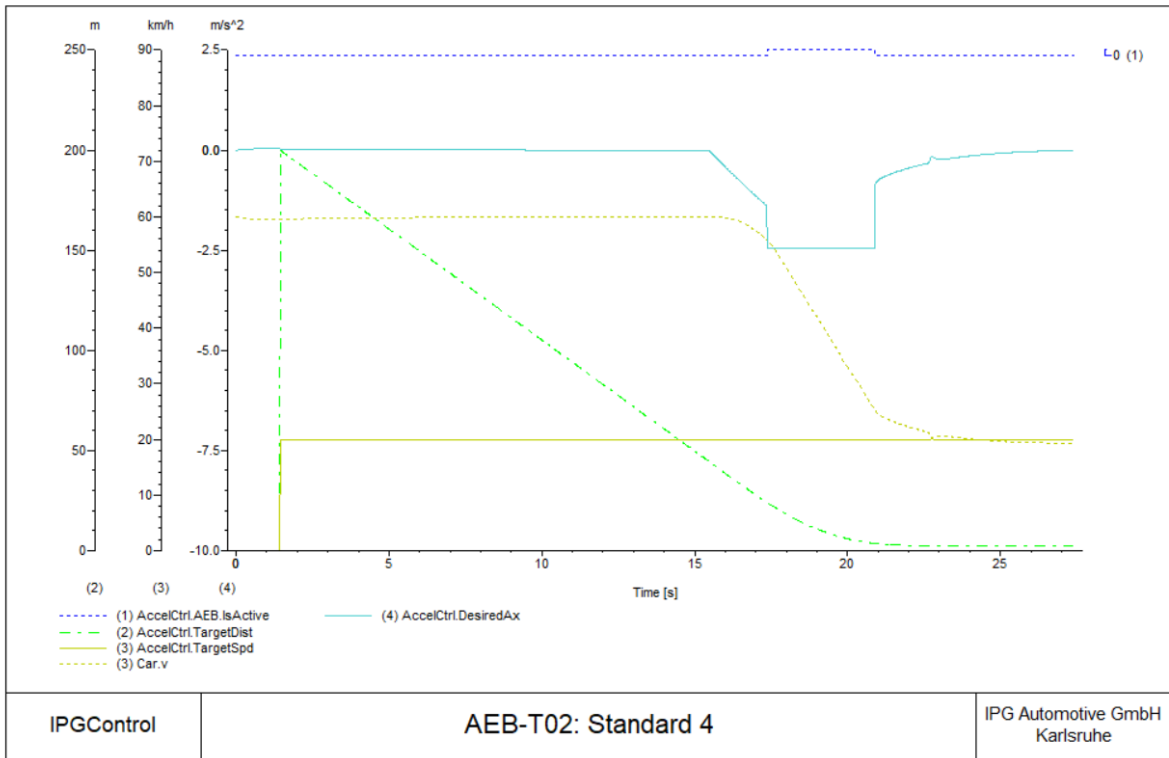

15.06.18 - 17:42

Figure 4.81: AEB-T02 Standard 4 result graph

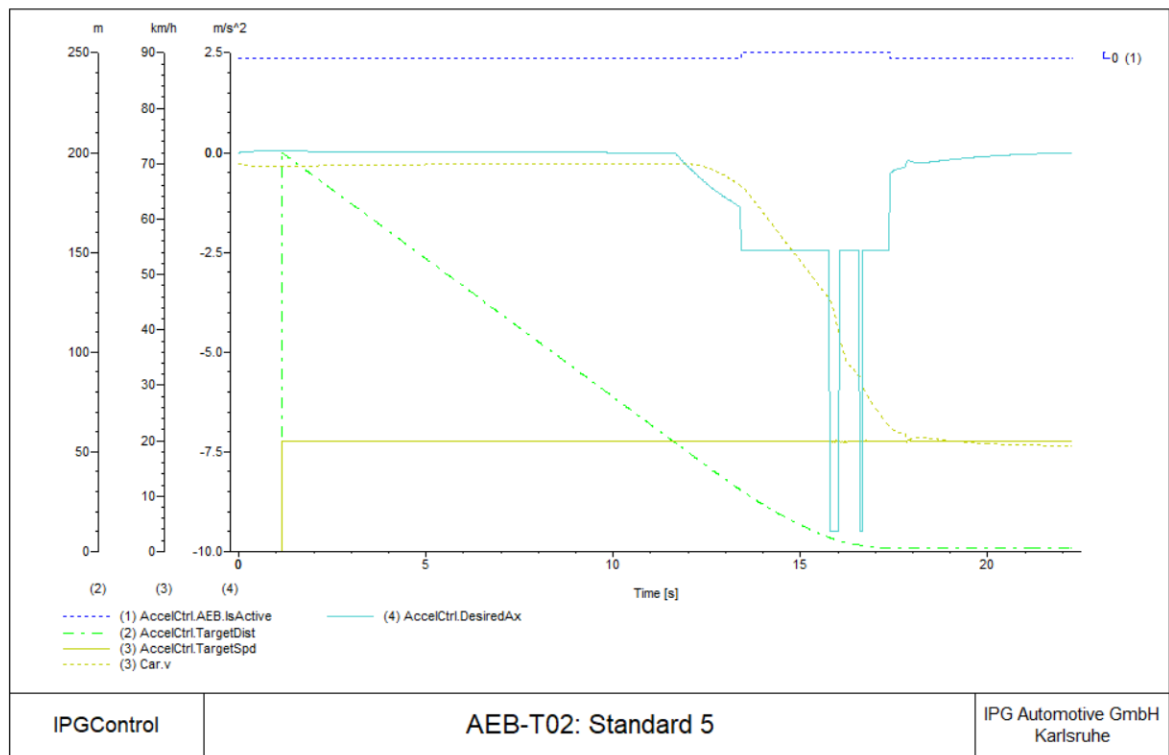

15.06.18 - 17:44

Figure 4.82: AEB-T02 Standard 5 result graph

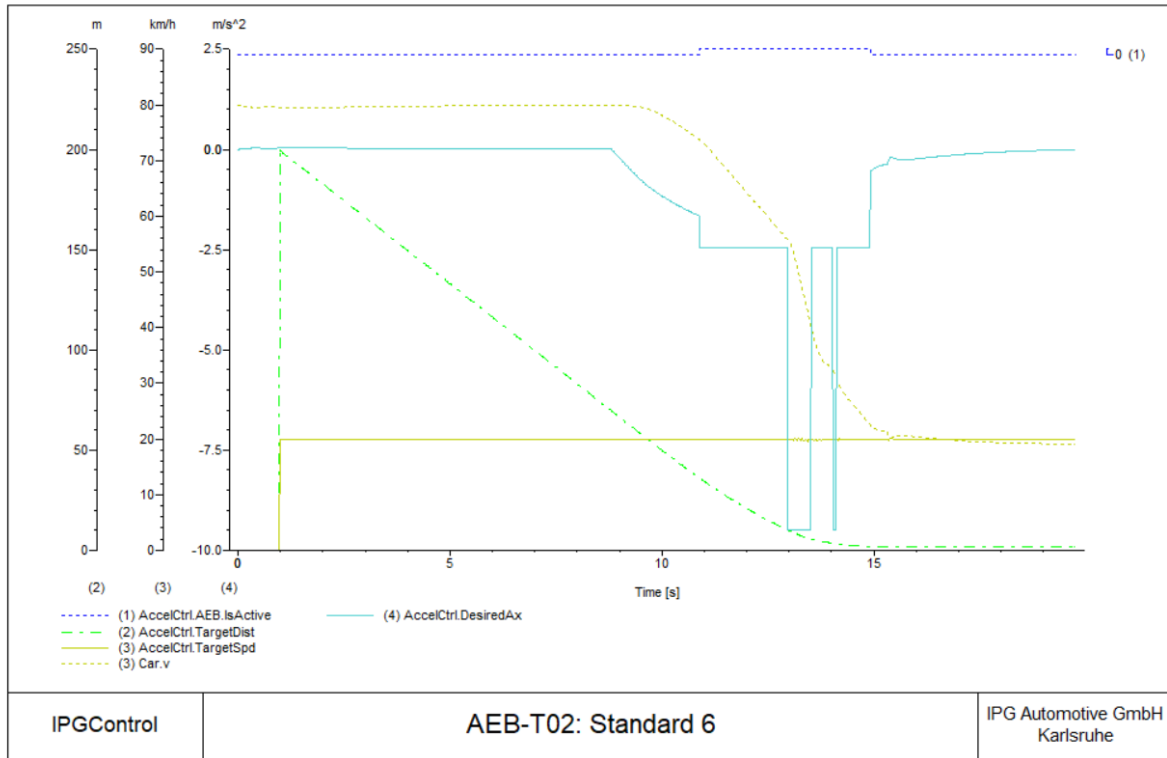

Figure 4.83: AEB-T02 Standard 6 result graph

As it is possible to see, increasing the host vehicle velocity will produce a higher deceleration request (displayed as a solid light blue line). In Standard 1, 2 and 3 tests the velocity difference between the host and the target vehicle was so small that the ACC was capable to manage the situation. On the other hand, in Standard 4 the pre-brake action of the AEB (displayed as a dotted blue line) was necessary, while in Standard 5 and 6 the full brake was activated. From the graphs it is possible to notice that initially the target vehicle is farther than the sensor range, which doesn't detect any object ahead, and so the host vehicle travels at its speed (dotted yellow line). When the sensor range is reached, the target vehicle is detected (with its speed reported as a solid yellow line), but the host car continues to approach because too far. When the VUT moves closer to the target vehicle, the ACC system intervenes, but, as soon as the TTC thresholds are reached, the pre-brake and the full brake AEB actions are performed.

To better understand the difference between the various variations, AccelCtrl.DesiredAx and AccelCtrl.TargetDist quantities are reported in Figure 4.84 and Figure 4.85, showing their trend during each test case. The two graphs reproduce the behavior of the previous diagrams, showing that increasing the host car velocity, the VUT will reach the target vehicle position earlier and with a higher deceleration request. This provokes a higher slope in the inter-vehicle distance as it decreases quicker. In dry road conditions ($C_f = 1$) all the test ends successfully.

The same test series were also reproduced with a lower friction coefficient ($C_f = 0.5$) simulating a wet road, which AccelCtrl.DesiredAx variations are shown in Figure 4.86. Also in this case, all the test ends successfully, except for the Standard 6, where is present a collision, as it is possible to see from the interrupted yellow line, and so which results in a fail. However, the impact speed was still decreased to 27.5 km/h, so with an initial speed reduction of 65.6%.

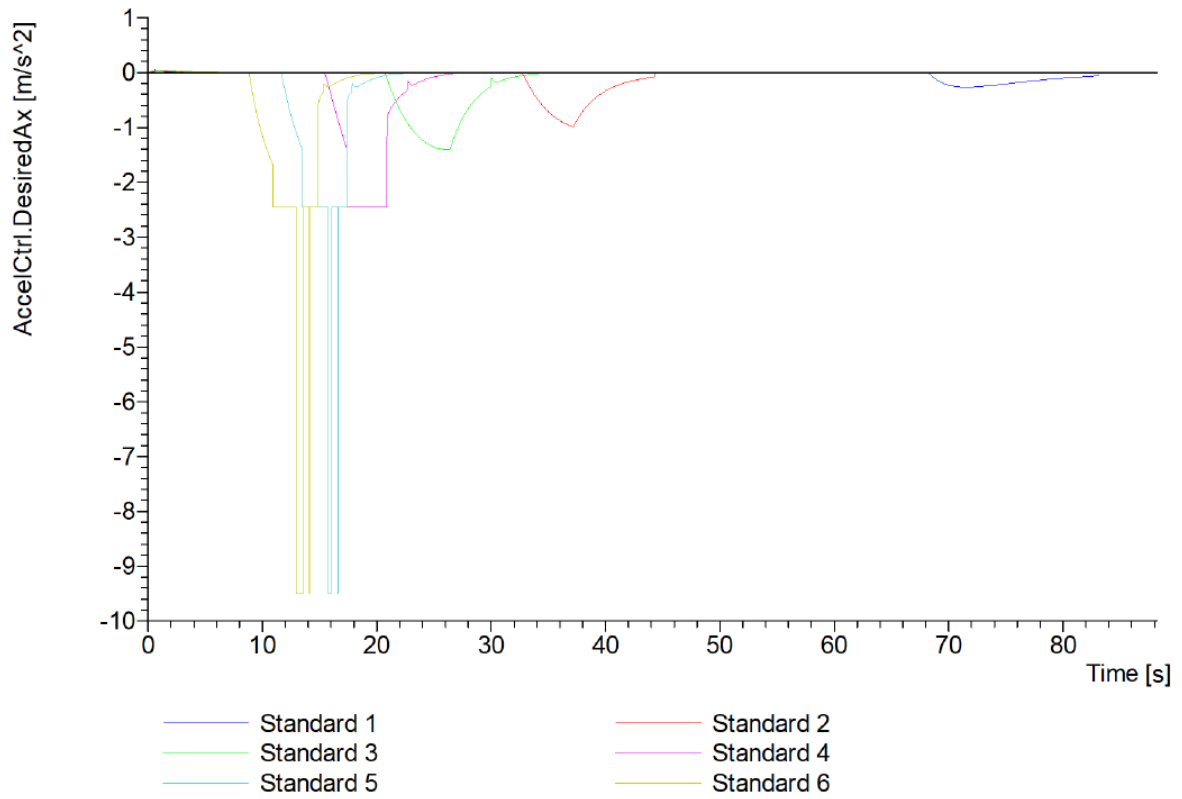

Figure 4.84: AEB-T02 AccelCtrl.DesiredAx variations result graph with Cf=1

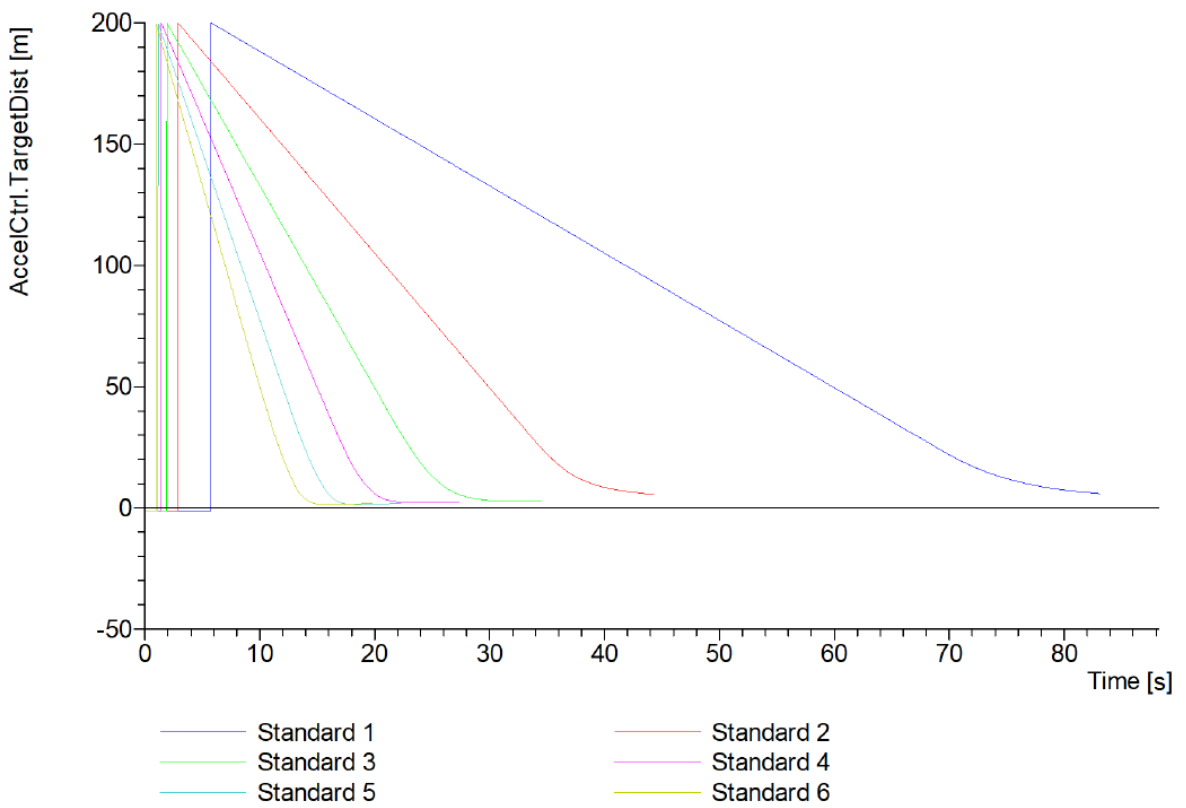

Figure 4.85: AEB-T02 AccelCtrl.TargetDist variations result graph with Cf=1

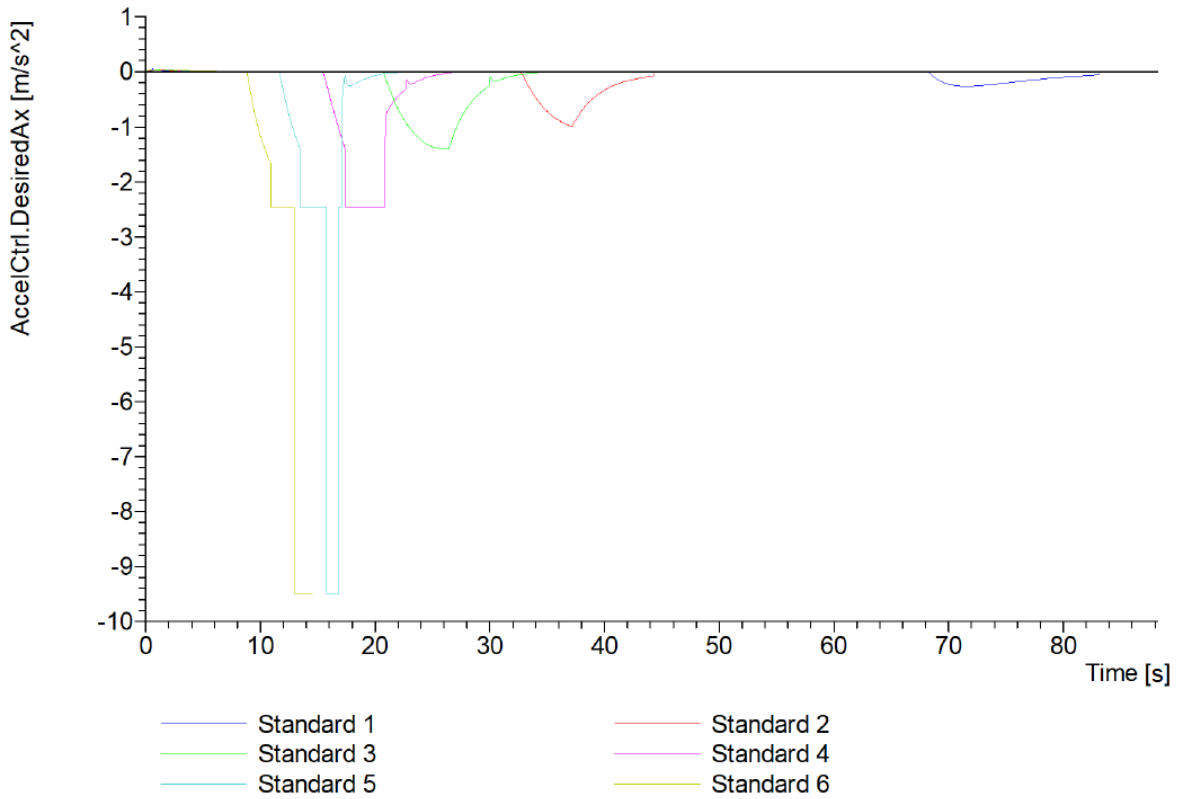

Figure 4.86: AEB-T02 AccelCtrl.DesiredAx variations result graph with Cf=0.5

4.4.2.3 AEB-T03: EuroNCAP CCRb – Following a decelerating vehicle

The goal of the test is to verify AEB action when the host car approaches a decelerating vehicle. In Figure 4.87 is shown the detailed result chart presented in the CarMaker test manager report, while in the following graphs the quantities trends for each case are reported.

Detailed Results

ID	Test	Result	
		C _f = 1	C _f = 0.5
3	Scenarios/AEB/AEB-T03_EuroNCAP_CCRb		
3.1	Standard 1	✓	✓
3.2	Standard 2	⚠	⚠
3.3	Standard 3	✓	✓
3.4	Standard 4	⚠	❌

Figure 4.87: AEB-T03 test series detailed results

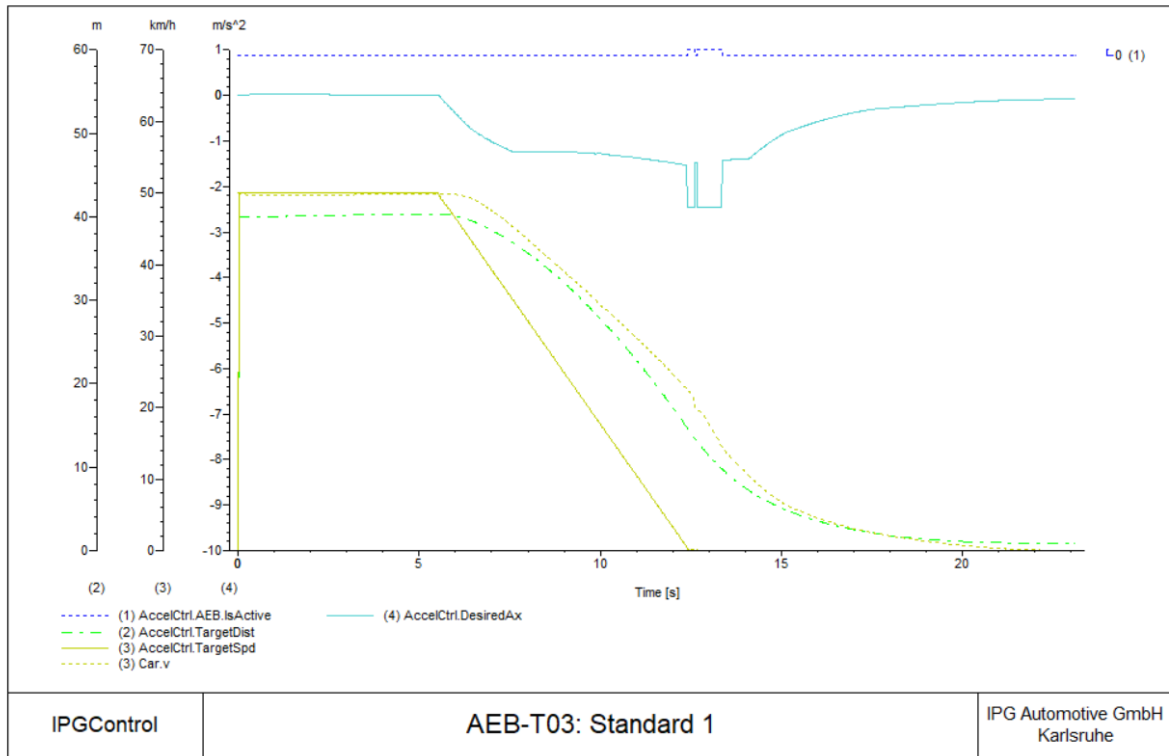

15.06.18 - 18.03

Figure 4.88: AEB-T03 Standard 1 result graph

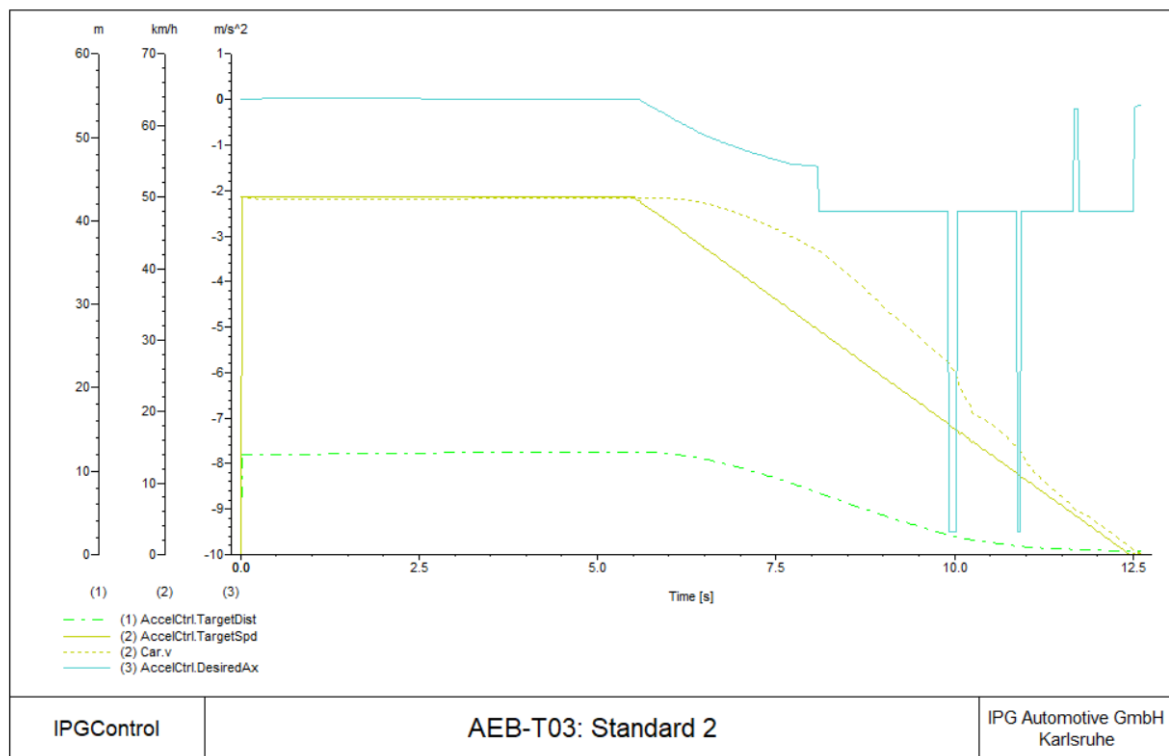

15.06.18 - 18.04

Figure 4.89: AEB-T03 Standard 2 result graph

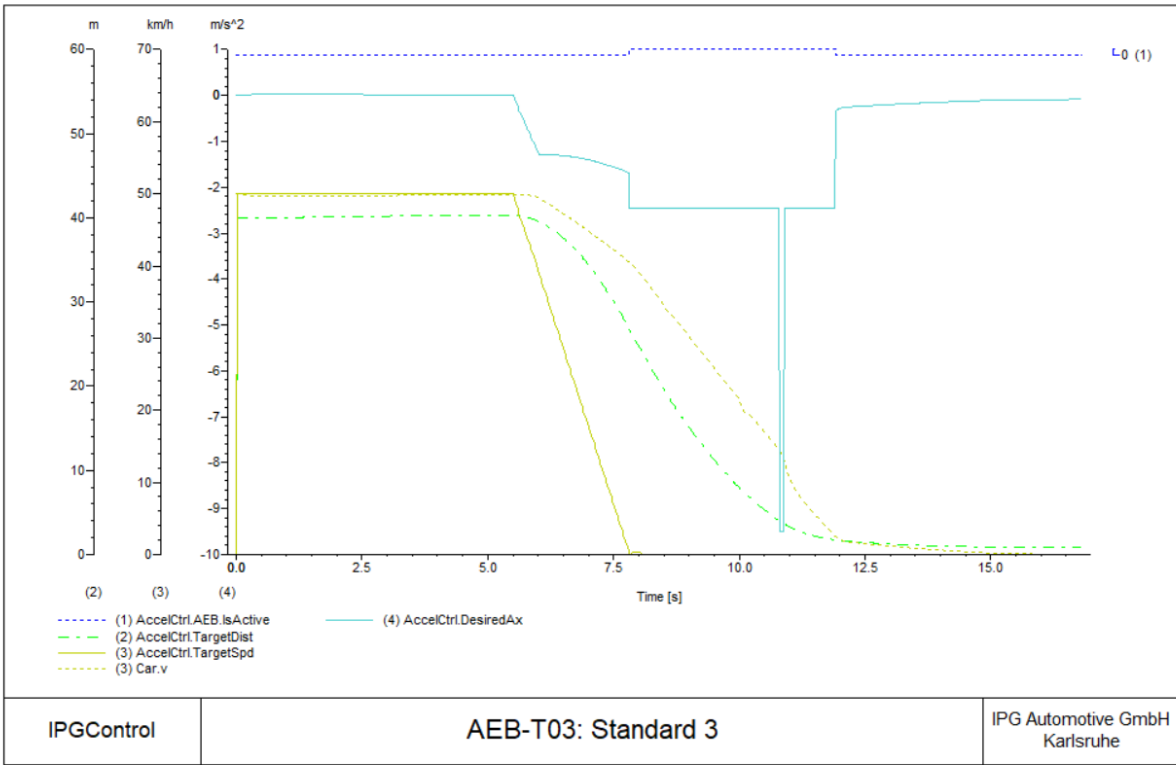

Figure 4.90: AEB-T03 Standard 3 result graph

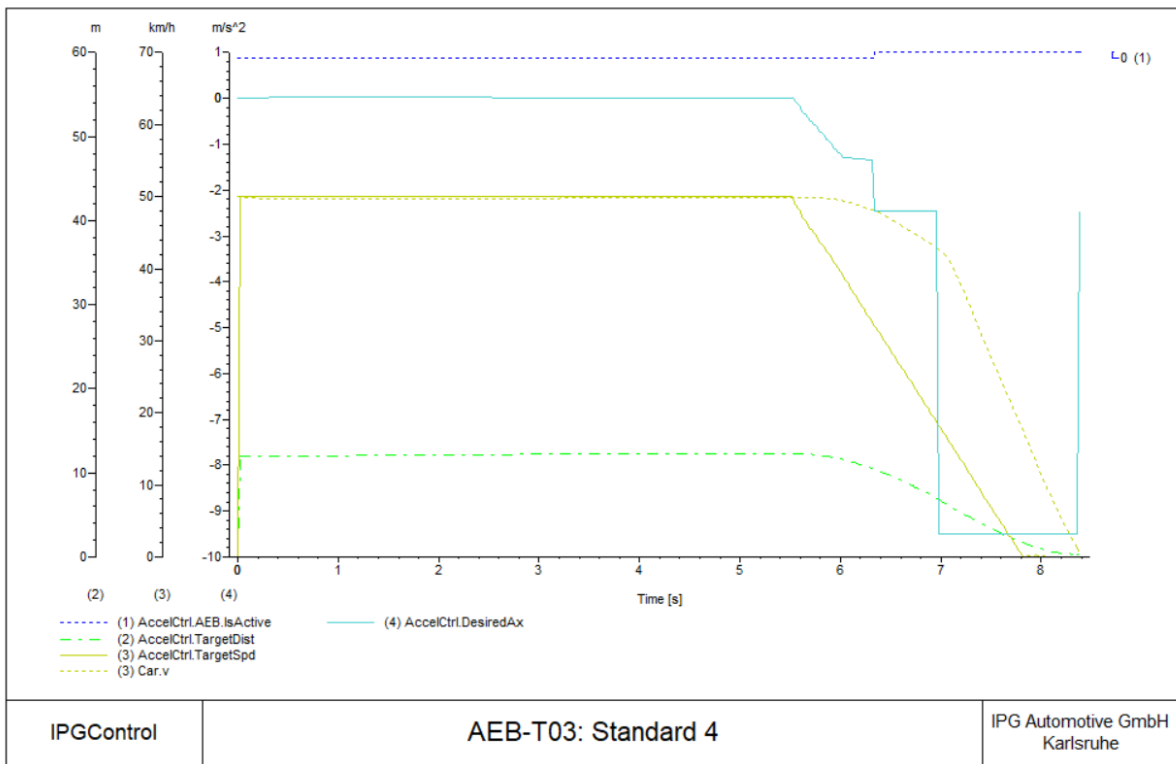

Figure 4.91: AEB-T03 Standard 4 result graph

As it is possible to see, decreasing the distance between the host and the target vehicle or increasing the target vehicle deceleration force, will produce a higher deceleration request (displayed as a solid light blue line), until the AEB activation (displayed as a dotted blue line). Critical are especially the situations where the inter-vehicle distance is reduced to 12m, as in Standard 2 and 4, where the tests are passed with warning. In Standard 1 the AEB pre-brake system activates, while in Standard 2, 3 and 4 the full brake force was necessary in order to avoid a collision.

In all cases it is possible to see how initially the host car is following the target vehicle at test distance (displayed as a dotted green line) and when the target vehicle decelerates (solid yellow line), the ACC system intervenes, but, as soon as the TTC thresholds are reached, the pre-brake and the full brake AEB actions are performed.

To better understand the difference between the various variations, AccelCtrl.DesiredAx and AccelCtrl.TargetDist quantities are reported in Figure 4.92 and Figure 4.93, showing their trend during each test case. The two graphs reproduce the behavior of the previous diagrams, showing that increasing the critical situation, the VUT will apply a higher deceleration request, so that the inter-vehicle distance is reduced quicker. In dry road conditions ($C_f = 1$) Standard 1 and 3 tests ends successfully, while in Standard 2 and 4 a minimum inter-vehicle distance of 0.4m and 0.3m respectively has been reached, leading to a warning.

The same test series were also reproduced with a lower friction coefficient ($C_f = 0.5$) simulating a wet road, which AccelCtrl.DesiredAx variations are shown in Figure 4.94. In this case, Standard 1 and 3 are still passed with success and Standard 2 with a warning (with minimum inter-vehicle distance of 0.3m), while in Standard 4 is present a collision, as it is possible to see from the interrupted pink line, which results in a fail. However, the impact speed was still decreased to 27.2 km/h, so with an initial speed reduction of 45.6%.

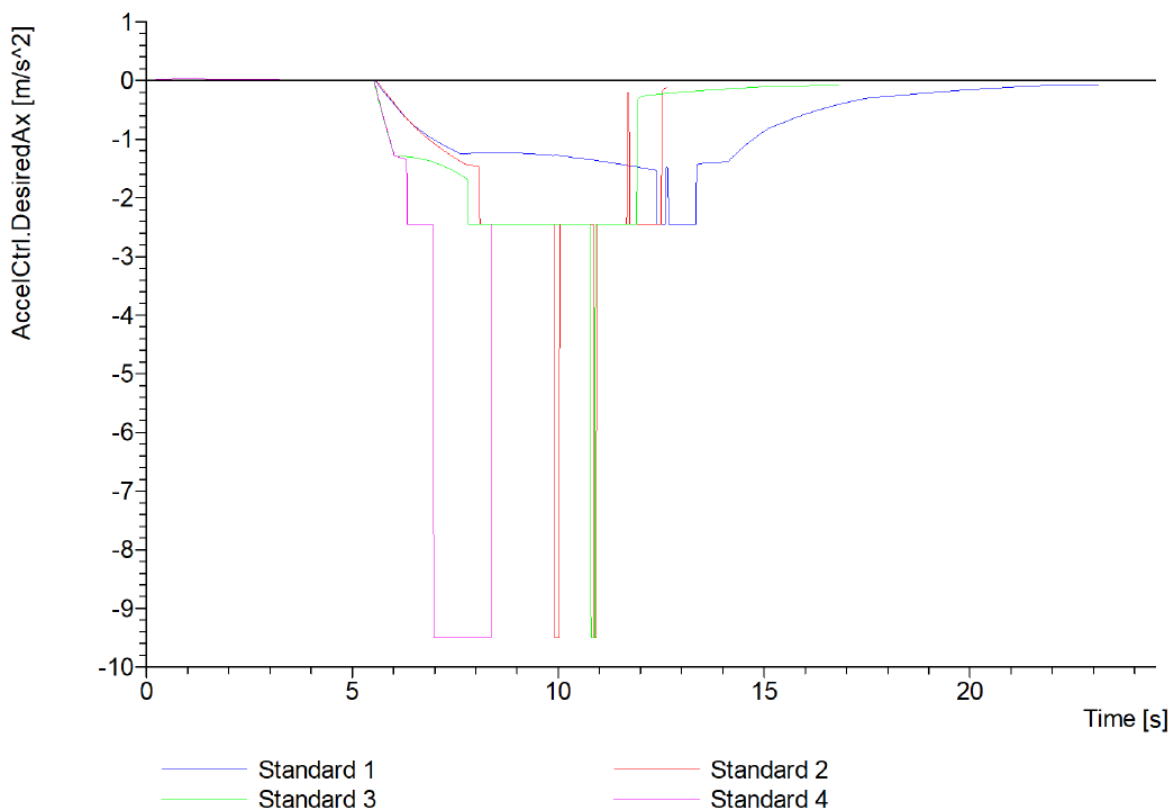

Figure 4.92: AEB-T03 AccelCtrl.DesiredAx variations result graph with $C_f=1$

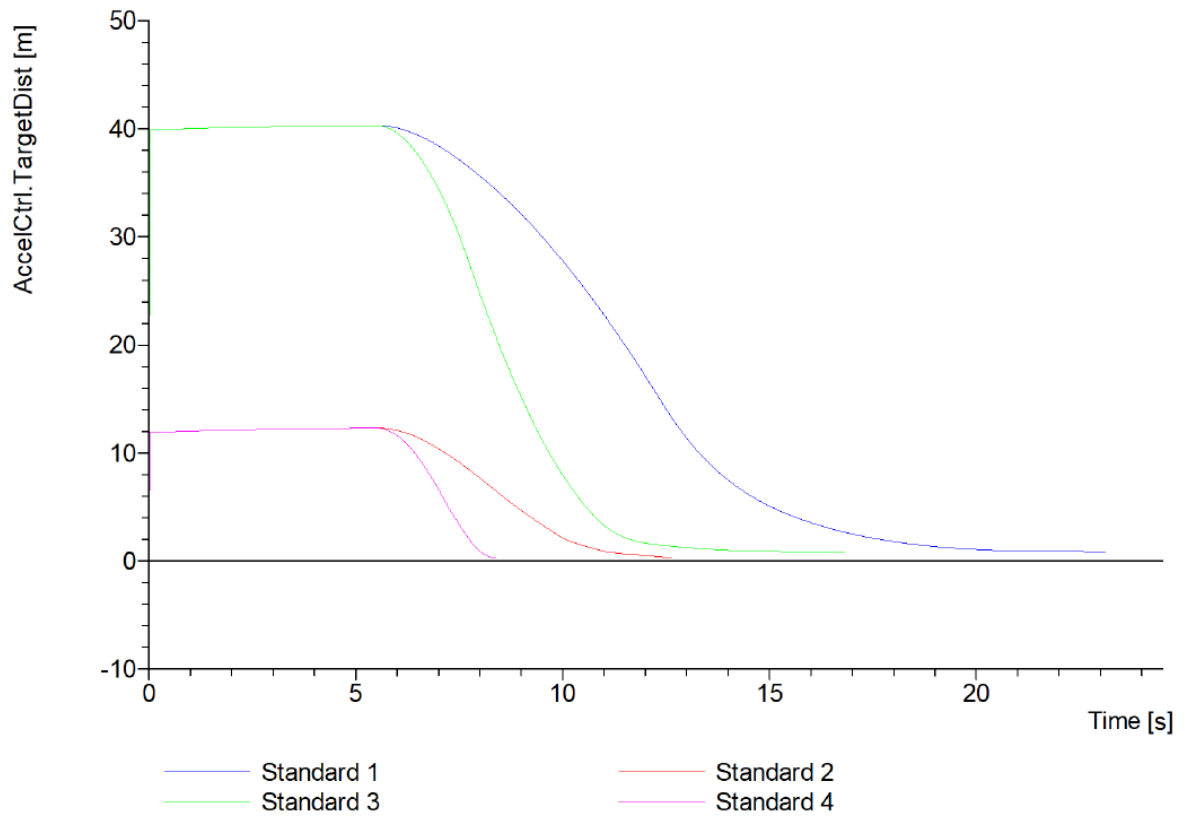

Figure 4.93: AEB-T03 AccelCtrl.TargetDist variations result graph with $C_f = 1$

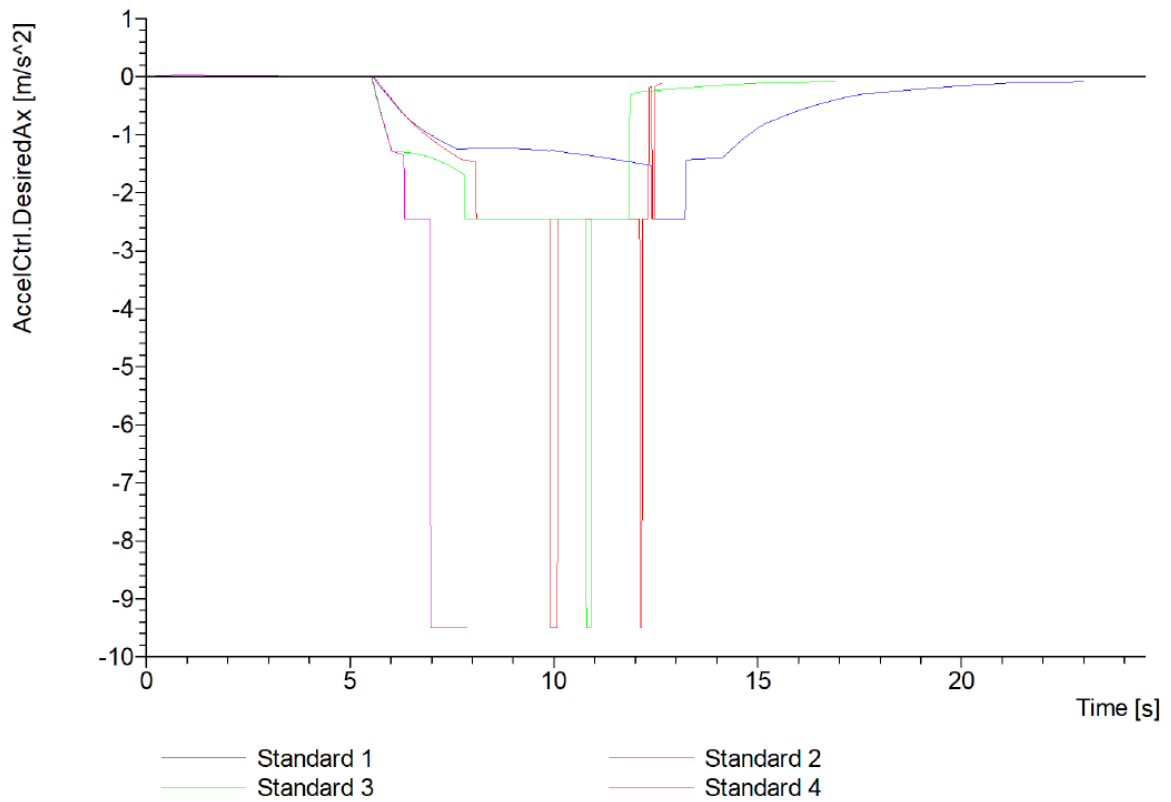

Figure 4.94: AEB-T03 AccelCtrl.DesiredAx variations result graph with $C_f = 0.5$

4.4.2.4 AEB-T04: EU 347/2012 – Approaching a slower moving vehicle

The goal of the test is to verify AEB action when the host car approaches a slower moving vehicle. In Figure 4.95 is shown the detailed result chart presented in the CarMaker test manager report, while in the following graphs the quantities trends for each case are reported.

Detailed Results

ID	Test	Result	
		C _f = 1	C _f = 0.5
4	Scenarios/AEB/AEB-T04_EU_347-2012		
4.1	Standard 1	✓	✓
4.2	Standard 2	✓	⚡
4.3	Variation 1	✓	✓
4.4	Variation 2	✓	⚡
4.5	Variation 3	⚠	⚡

Figure 4.95: AEB-T04 test series detailed results

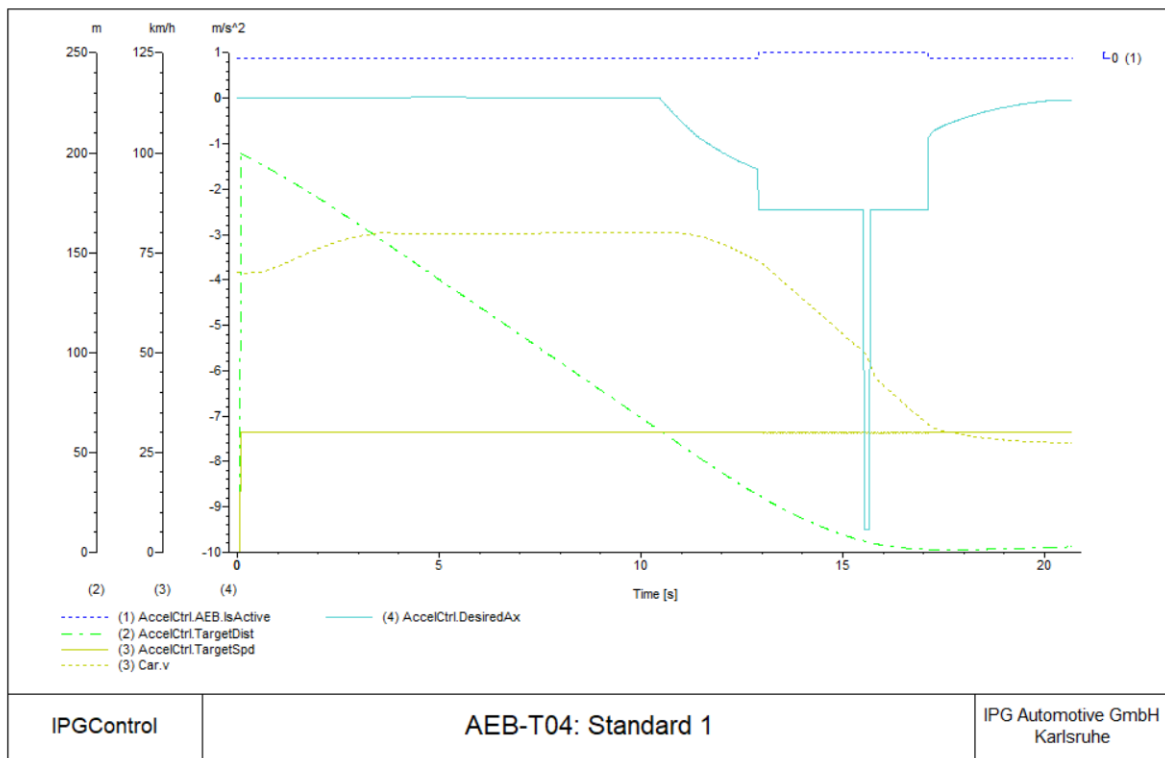
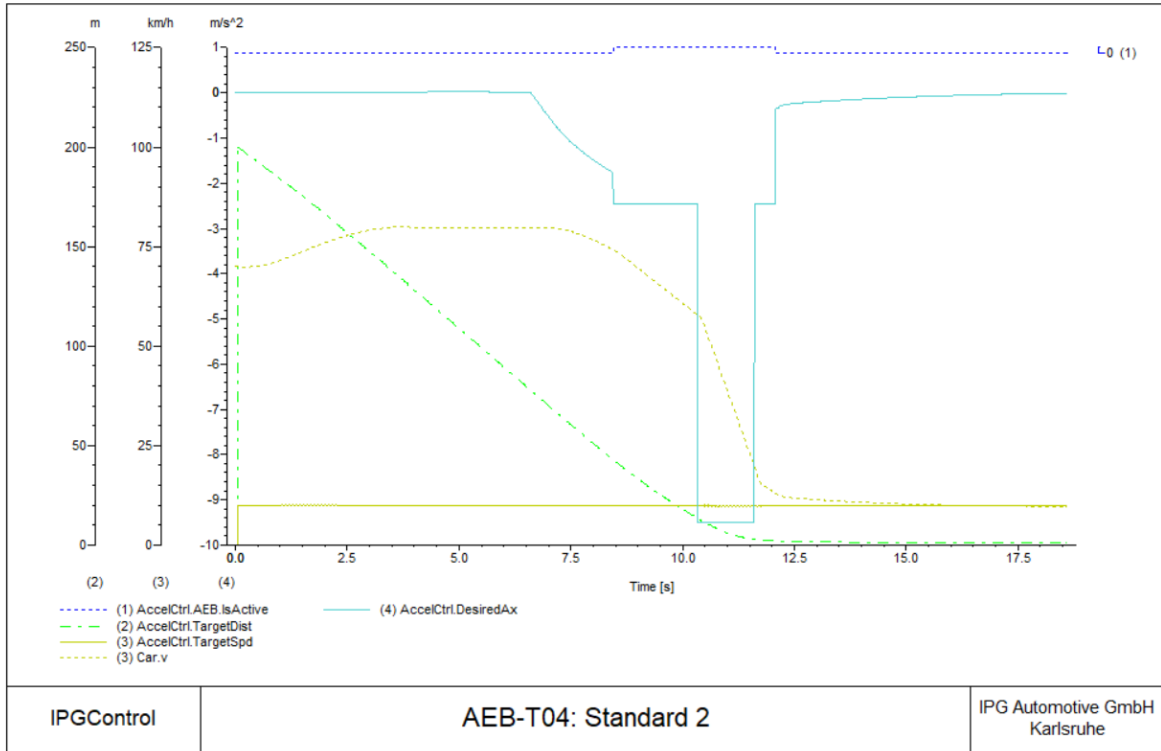
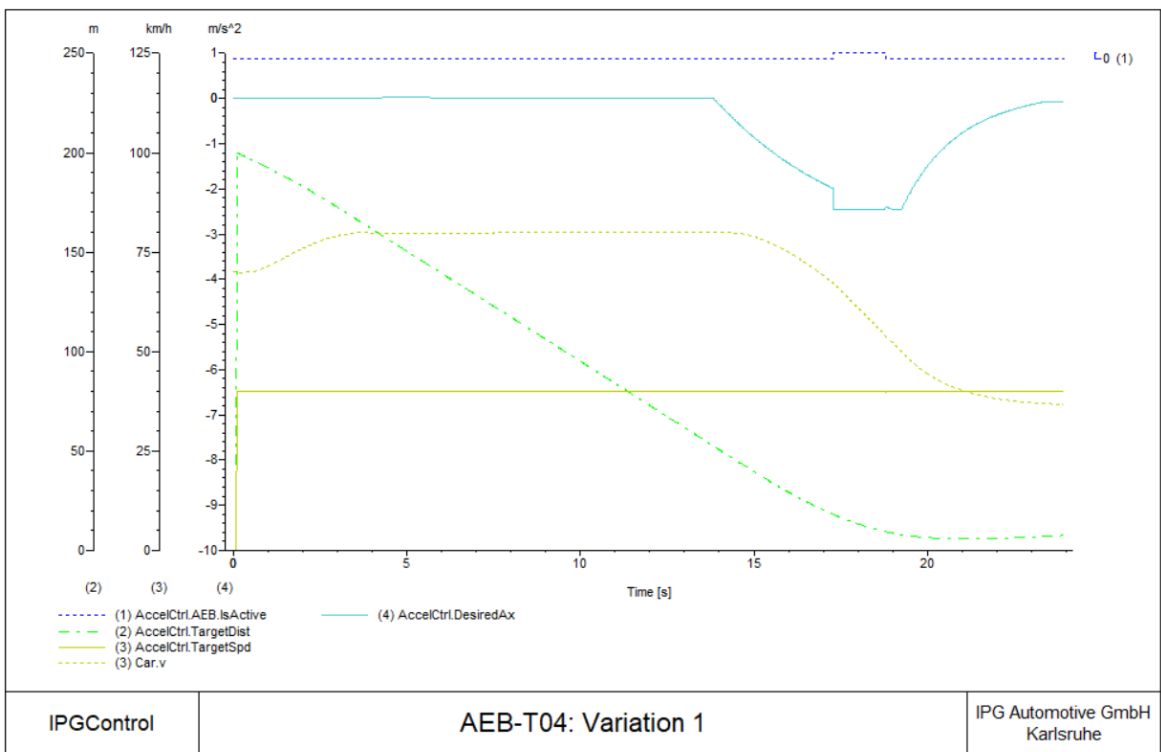

Figure 4.96: AEB-T04 Standard 1 result graph



15.06.18 - 18:20

Figure 4.97: AEB-T04 Standard 2 result graph



15.06.18 - 18:21

Figure 4.98: AEB-T04 Variation 1 result graph

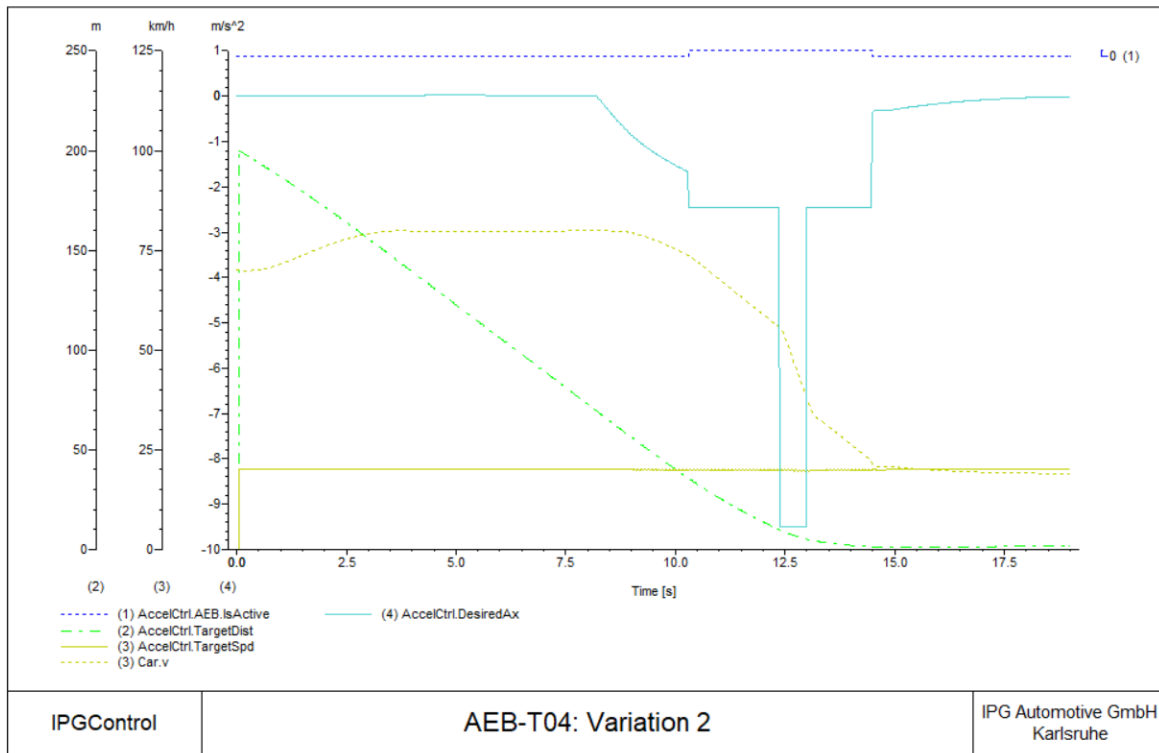

15.06.18 - 18:23

Figure 4.99: AEB-T04 Variation 2 result graph

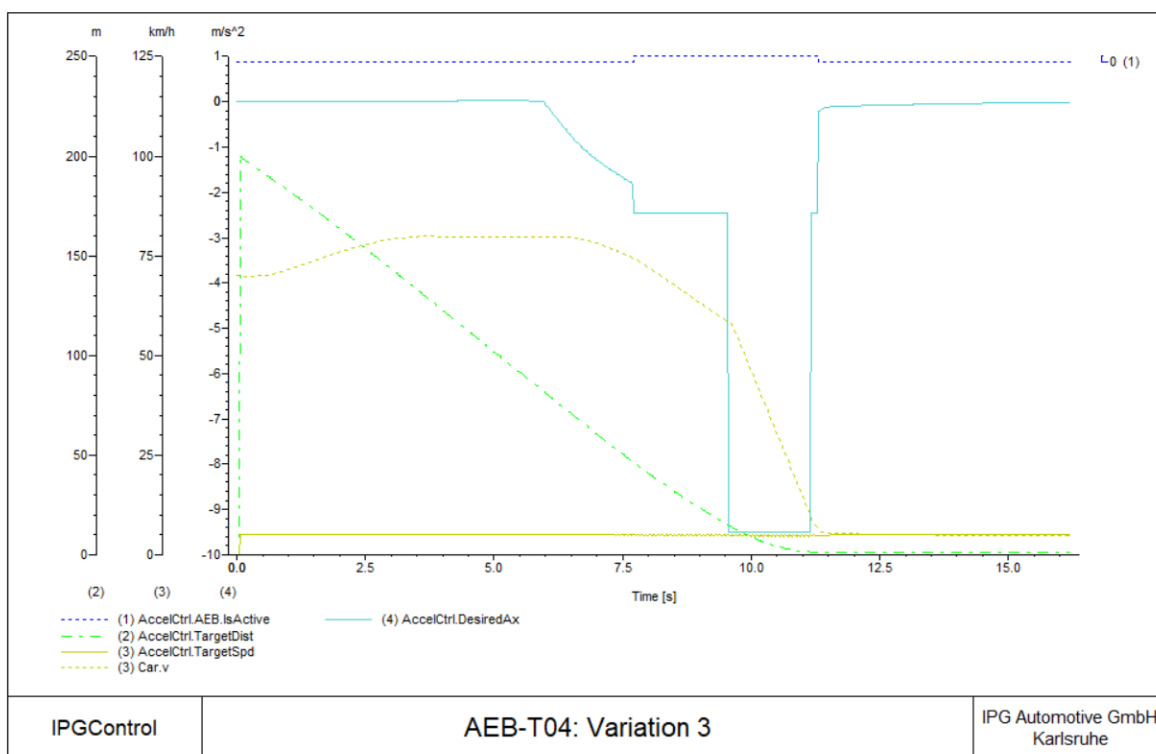

15.06.18 - 18:25

Figure 4.100: AEB-T04 Variation 3 result graph

As it is possible to see, decreasing the target vehicle velocity will produce a higher deceleration request (displayed as a solid light blue line), until the AEB activation (displayed as a dotted blue line). In the Variation 1 test, the pre-brake action was sufficient to avoid a vehicle collision, while in the others tests the full brake is activated, longer with higher speeds.

In all cases it is possible to see how the host vehicle velocity starts from 70km/h and increases until it reaches the test speed of 80km/h. When the VUT moves closer to the target vehicle, the ACC system intervenes, but, as soon as the TTC thresholds are reached, the pre-brake and the full brake AEB actions are performed.

To better understand the difference between the various variations, AccelCtrl.DesiredAx and AccelCtrl.TargetDist quantities are reported in Figure 4.101 and Figure 4.102, showing their trend during each test case. The two graphs reproduce the behavior of the previous diagrams, showing that decreasing the target vehicle velocity, the inter-vehicle distance is reduced quicker due to a higher deceleration request. In dry road conditions ($C_f = 1$) all the test ends successfully, except for Variation 3 test, where a minimum inter-vehicle distance of 1.3m is reached, leading to a warning.

The same test series were also reproduced with a lower friction coefficient ($C_f = 0.5$) simulating a wet road, which AccelCtrl.DesiredAx variations are shown in Figure 4.103. In this case, Standard 1 and Variation 1 test are still passed successfully, while decreasing the target vehicle speed starting from 20km/h will lead to a collision, and so to a fail. However, the impact speed of Standard 2, Variation 2 and 3 was still decreased to 37.2 km/h, 31.4 km/h and 38.7 km/h, so with an initial speed reduction of 53.5%, 60.7% and 51.6% respectively.

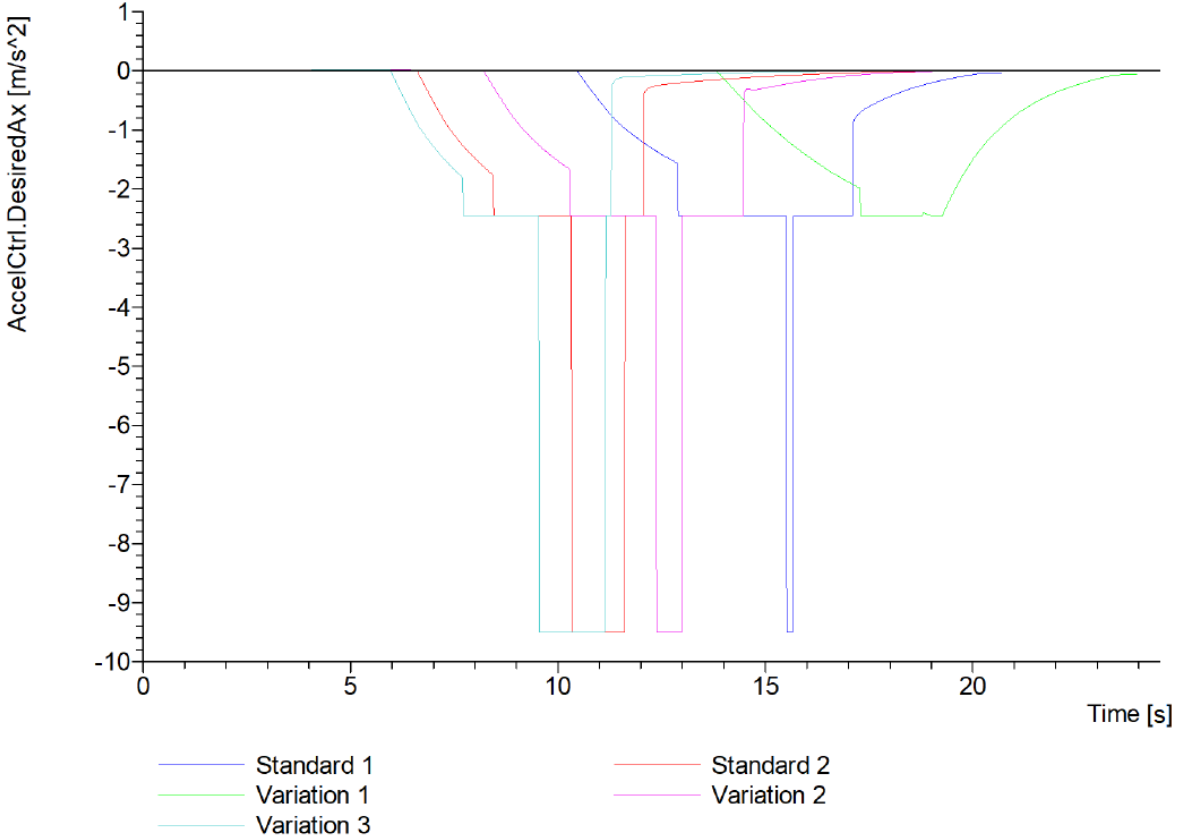

Figure 4.101: AEB-T04 AccelCtrl.DesiredAx variations result graph with $C_f = 1$

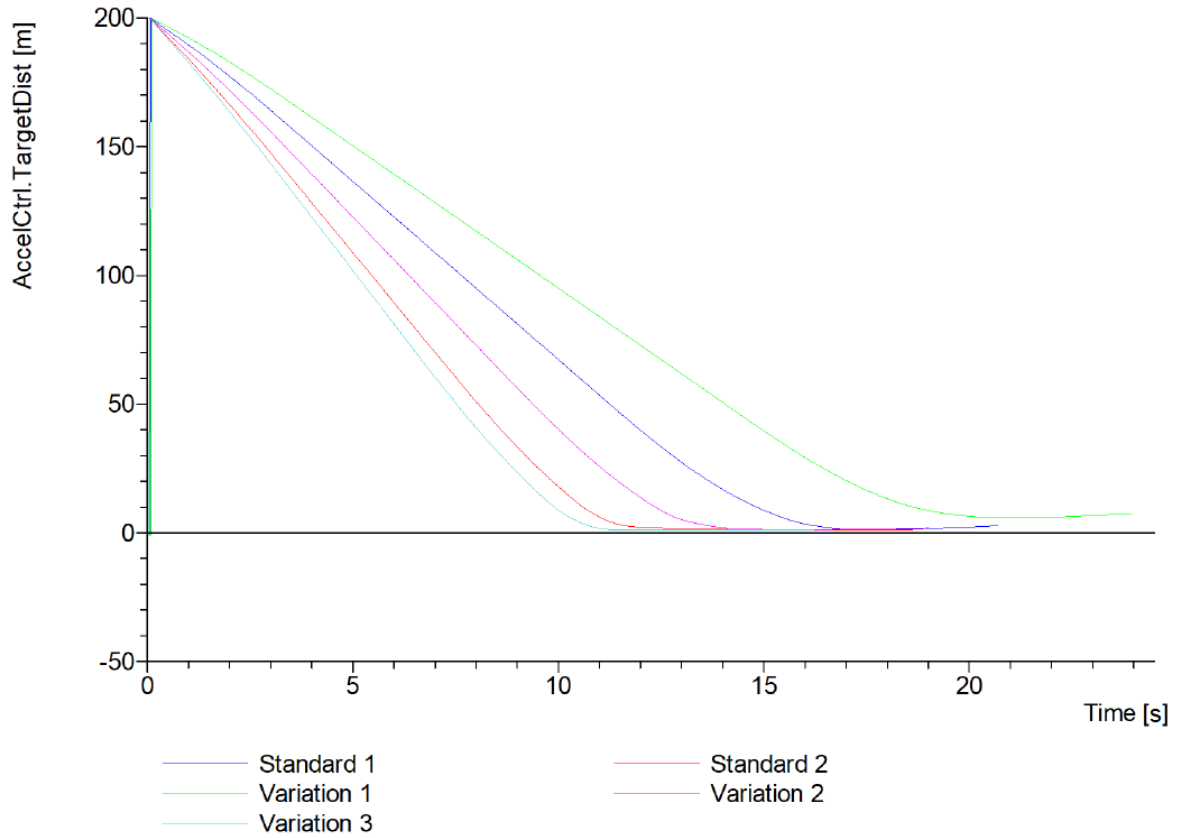

Figure 4.102: AEB-T04 AccelCtrl.TargetDist variations result graph with $C_f=1$

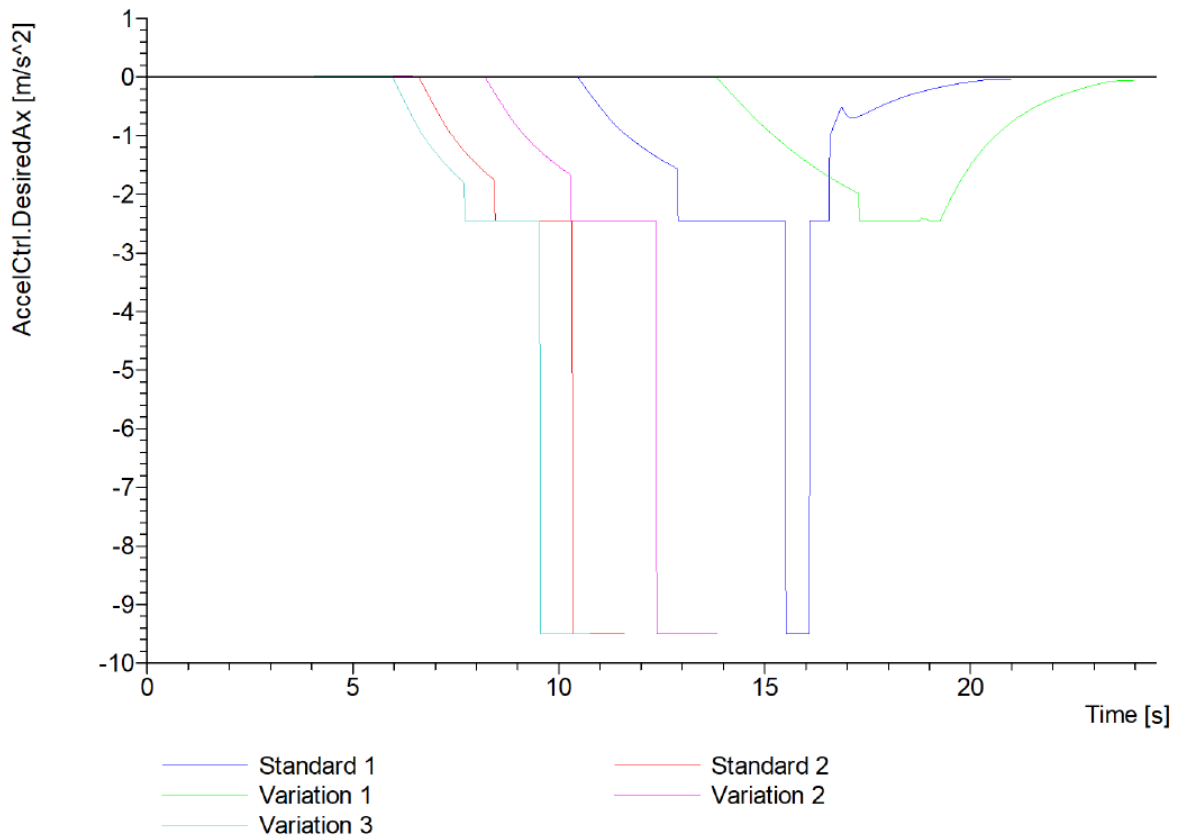

Figure 4.103: AEB-T04 AccelCtrl.DesiredAx variations result graph with $C_f=0.5$

4.4.2.5 AEB-T05: ISO 22179 – Following a decelerating vehicle

The goal of the test is to verify AEB action when the host car approaches a decelerating vehicle. In Figure 4.104 is shown the detailed result chart presented in the CarMaker test manager report, while in the following graphs the quantities trends for each case are reported.

Detailed Results

ID	Test	Result	
		C _f = 1	C _f = 0.5
5	Scenarios/AEB/AEB-T05_ISO_22179_CCRb		
5.1	Standard	✓	✓
5.2	Variation 1	✓	✓
5.3	Variation 2	✓	✓
5.4	Variation 3	✓	⚠

Figure 4.104: AEB-T05 test series detailed results

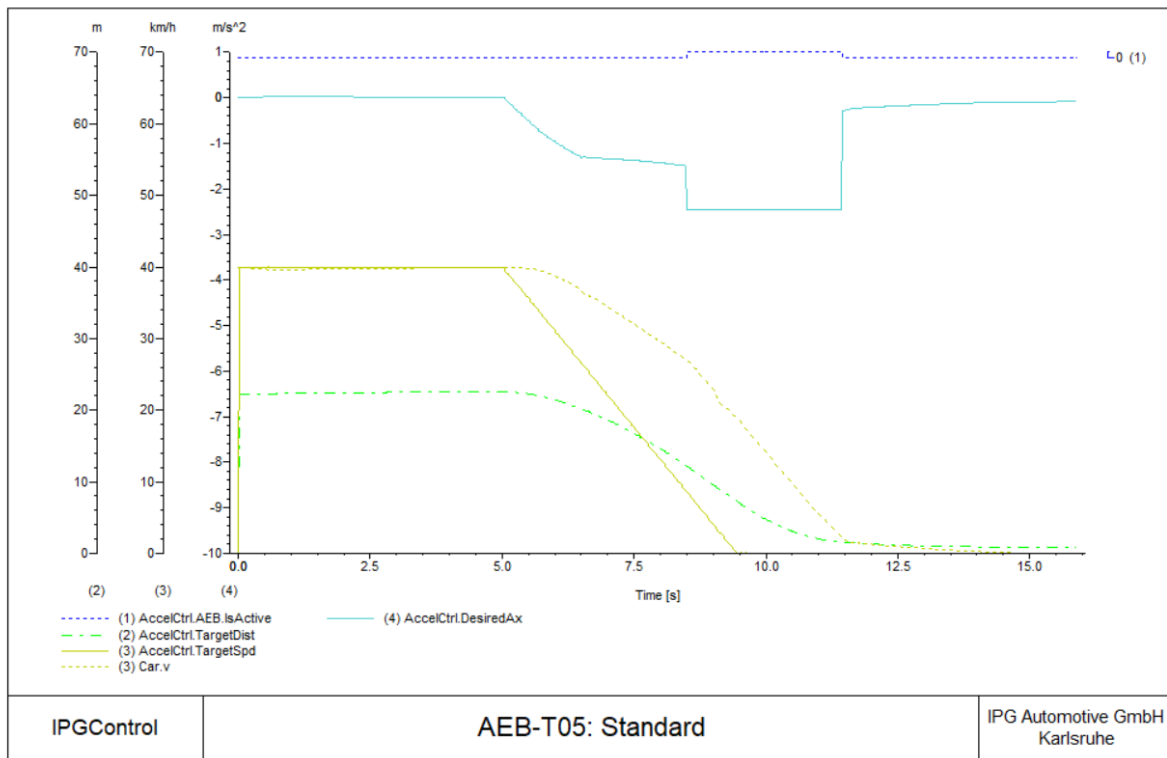

Figure 4.105: AEB-T05 Standard result graph

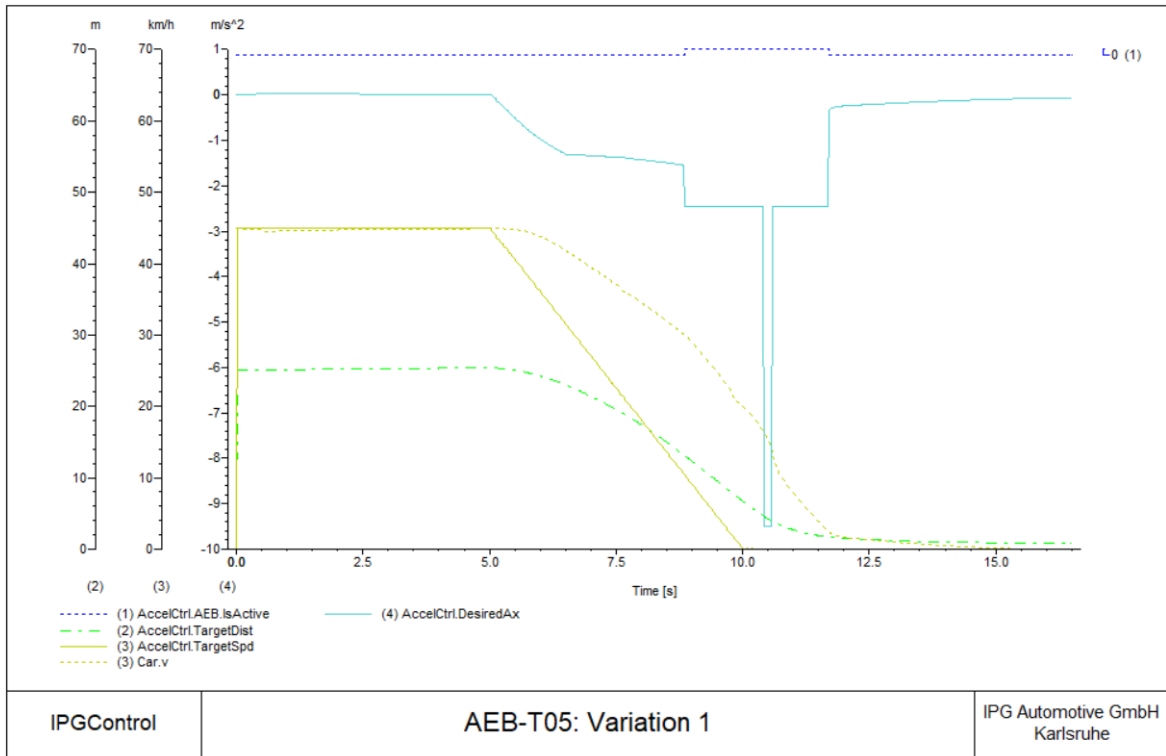

Figure 4.106: AEB-T05 Variation 1 result graph

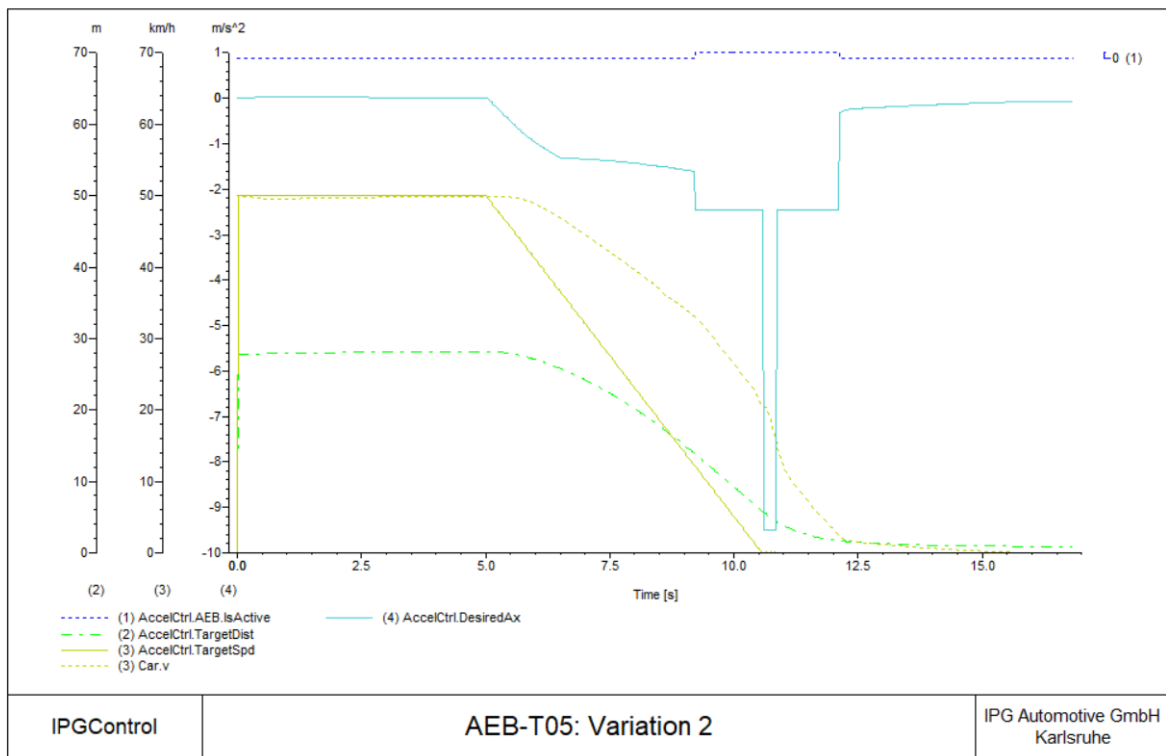

Figure 4.107: AEB-T05 Variation 2 result graph

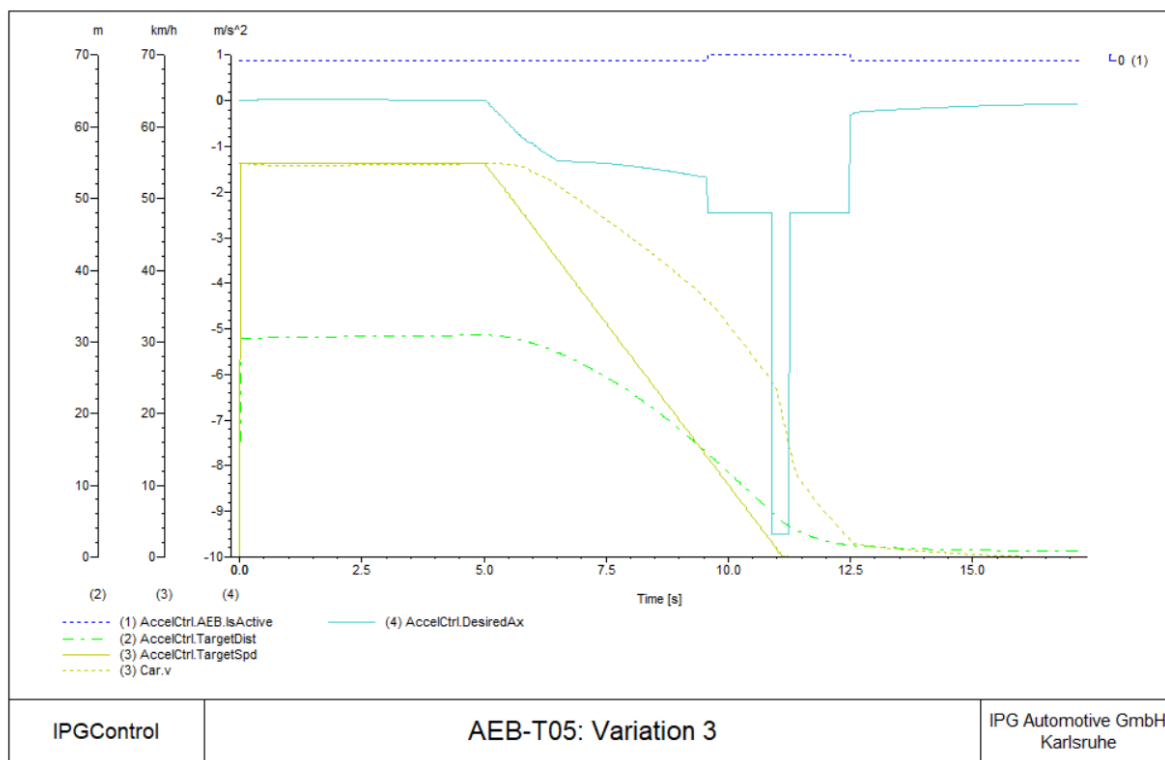

Figure 4.108: AEB-T05 Variation 3 result graph

As it is possible to see, increasing the starting host and target vehicle velocity will produce a higher deceleration request (displayed as a solid light blue line) when the latter decides to brake, making necessary AEB intervention (displayed as a dotted blue line). The results shown as this scenario is not a particular critical one, as every test series are passed with success. Moreover, in the Standard test, the pre-brake action was sufficient to avoid a vehicle collision, while in the others tests the full brake is activated.

In all cases it is possible to see how initially the host car is following the target vehicle at test distance (displayed as a dotted green line) and when the target vehicle decelerates (solid yellow line), the ACC system firstly activates, but, as soon as the TTC thresholds are reached, the pre-brake and the full brake AEB actions are performed.

To better understand the difference between the various variations, AccelCtrl.DesiredAx and AccelCtrl.TargetDist quantities are reported in Figure 4.109 and Figure 4.110, showing their trend during each test case. The two graphs reproduce the behavior of the previous diagrams, showing that increasing the critical situation, the VUT will apply a higher deceleration request, and the inter-vehicle distance, starting from a different value, is reduced as a consequence. In dry road conditions ($C_f = 1$) all the test ends successfully.

The same test series were also reproduced with a lower friction coefficient ($C_f = 0.5$) simulating a wet road, which AccelCtrl.DesiredAx variations are shown in Figure 4.111. Also in this case, all the test ends successfully except for the Variation 3, with a minimum inter-vehicle distance of 1m, leading to a warning.

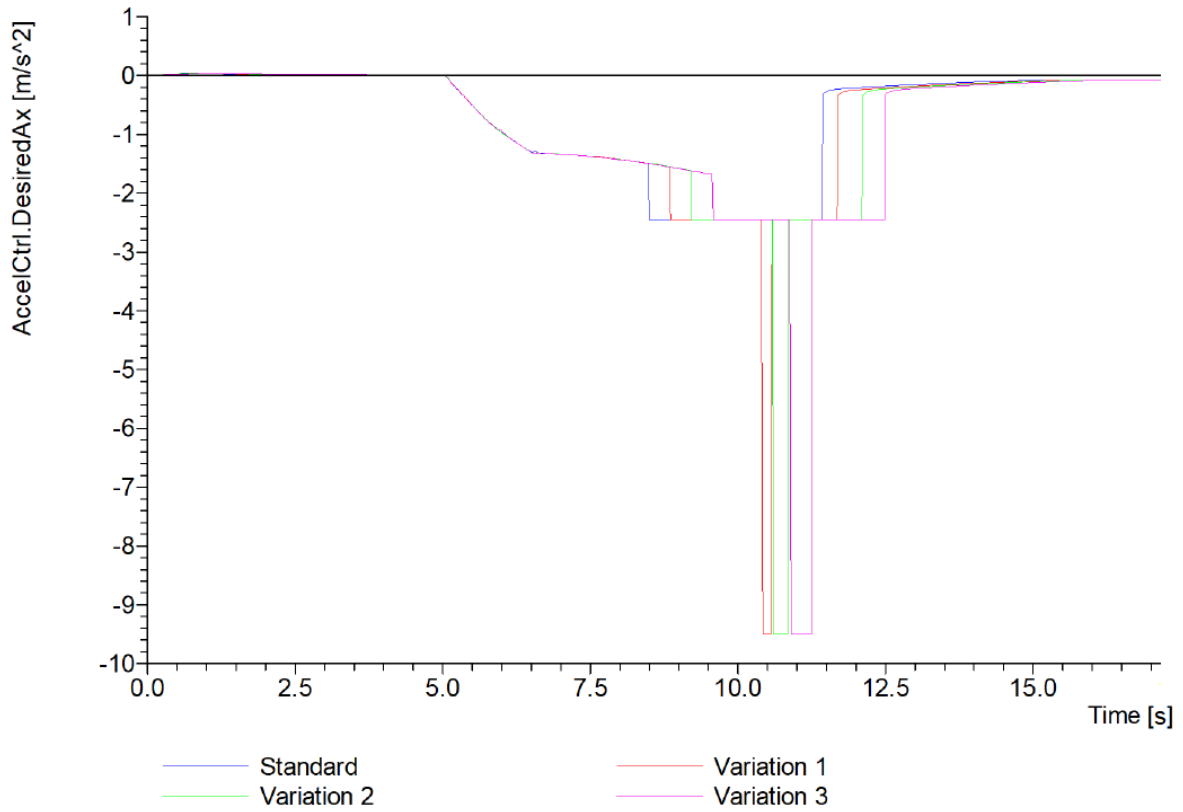

Figure 4.109: AEB-T05 AccelCtrl.DesiredAx variations result graph with $C_f=1$

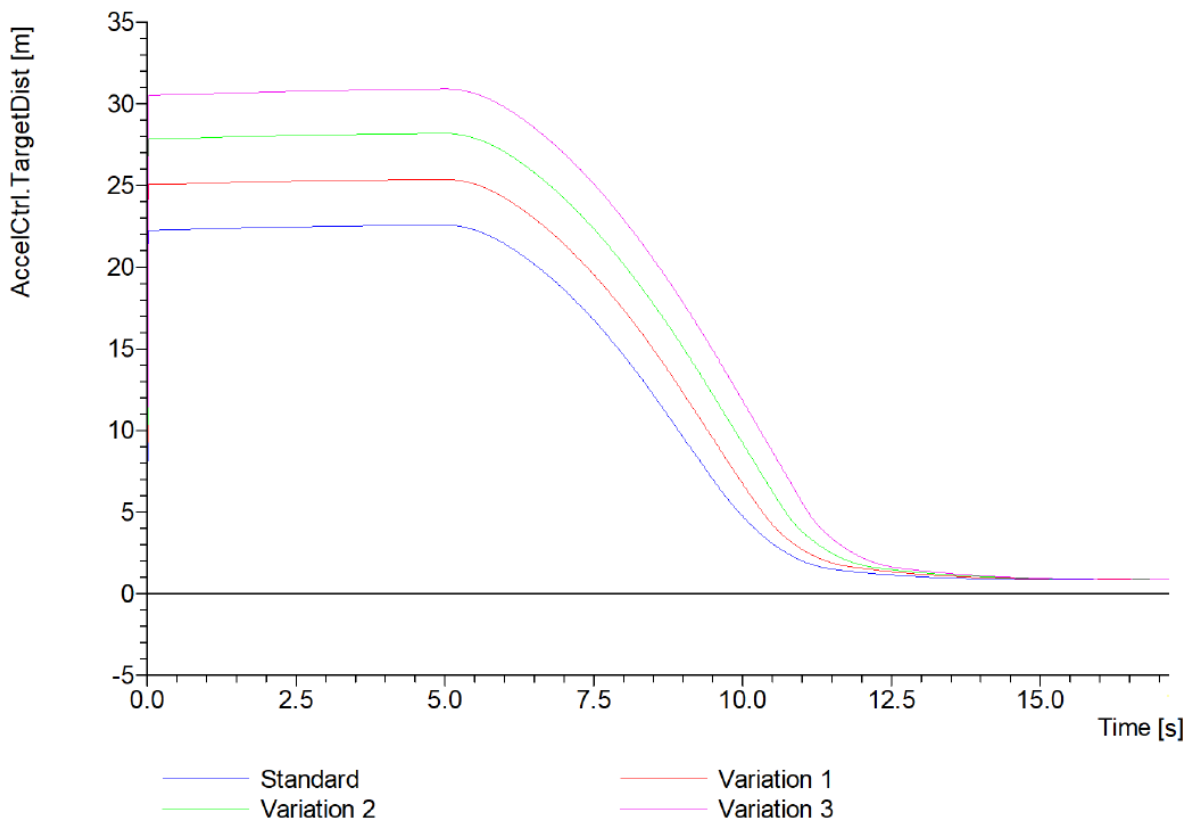

Figure 4.110: AEB-T05 AccelCtrl.TargetDist variations result graph with $C_f=1$

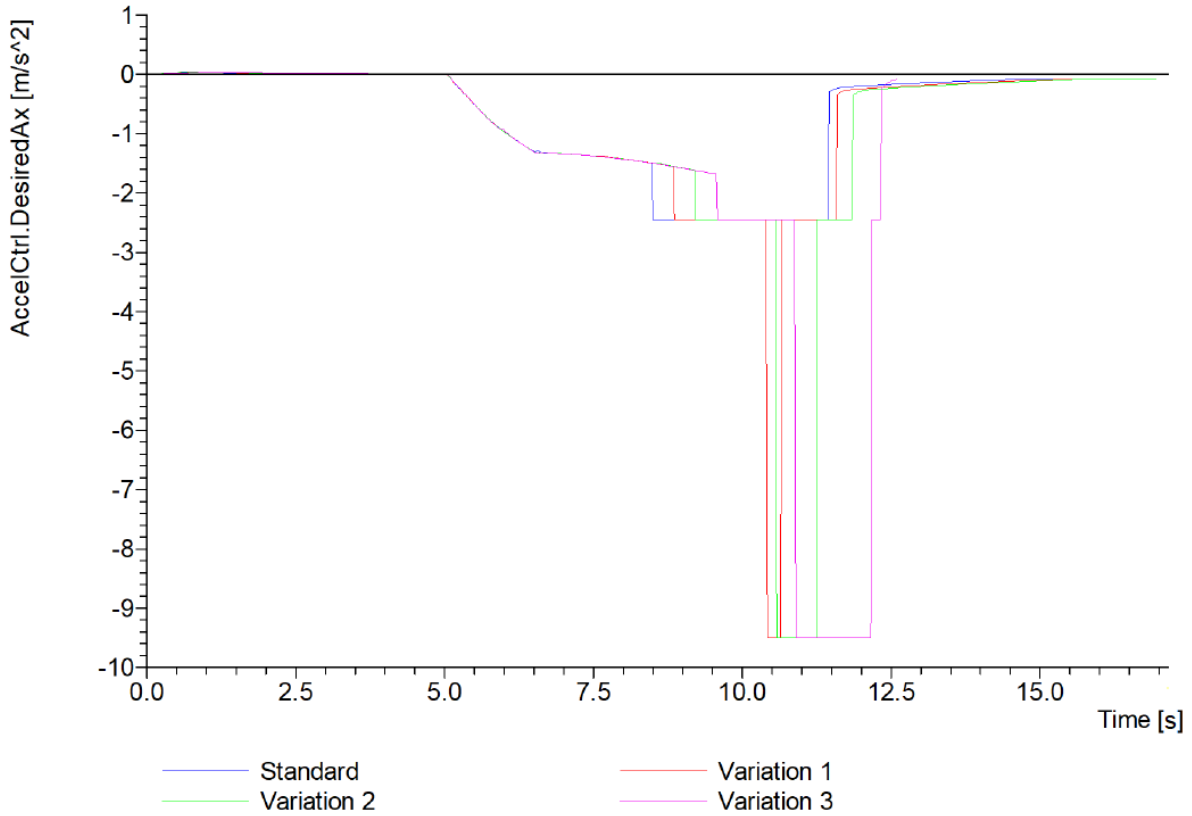

Figure 4.111: AEB-T05 AccelCtrl.DesiredAx variations result graph with Cf=0.5

4.4.2.6 AEB-T06: CTU-C – Static target encounter after vehicle cut-out

The goal of the test is focused on evaluating the promptness of the AEB system in case of an unexpected static target after the preceding moving target cuts out. In Figure 4.112 is shown the detailed result chart presented in the CarMaker test manager report, while in the following graphs the quantities trends for each case are reported.

Detailed Results

ID	Test	Result	
		C _f = 1	C _f = 0.5
6	Scenarios/AEB/AEB-T06_CTU-C		
6.1	Standard	❌	❌
6.2	Variation 1	⚠️	❌
6.3	Variation 2	✅	❌
6.4	Variation 3	✅	⚠️
6.5	Variation 4	✅	✅

Figure 4.112: AEB-T06 test series detailed results

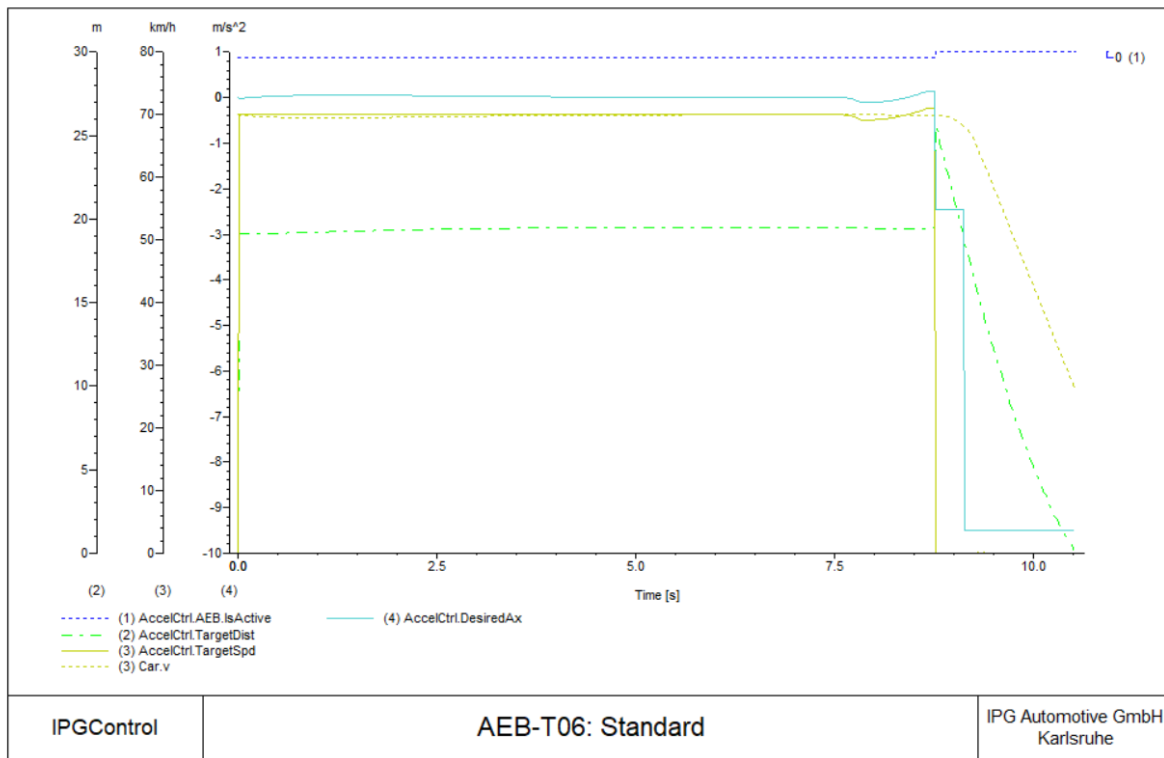

Figure 4.113: AEB-T06 Standard result graph

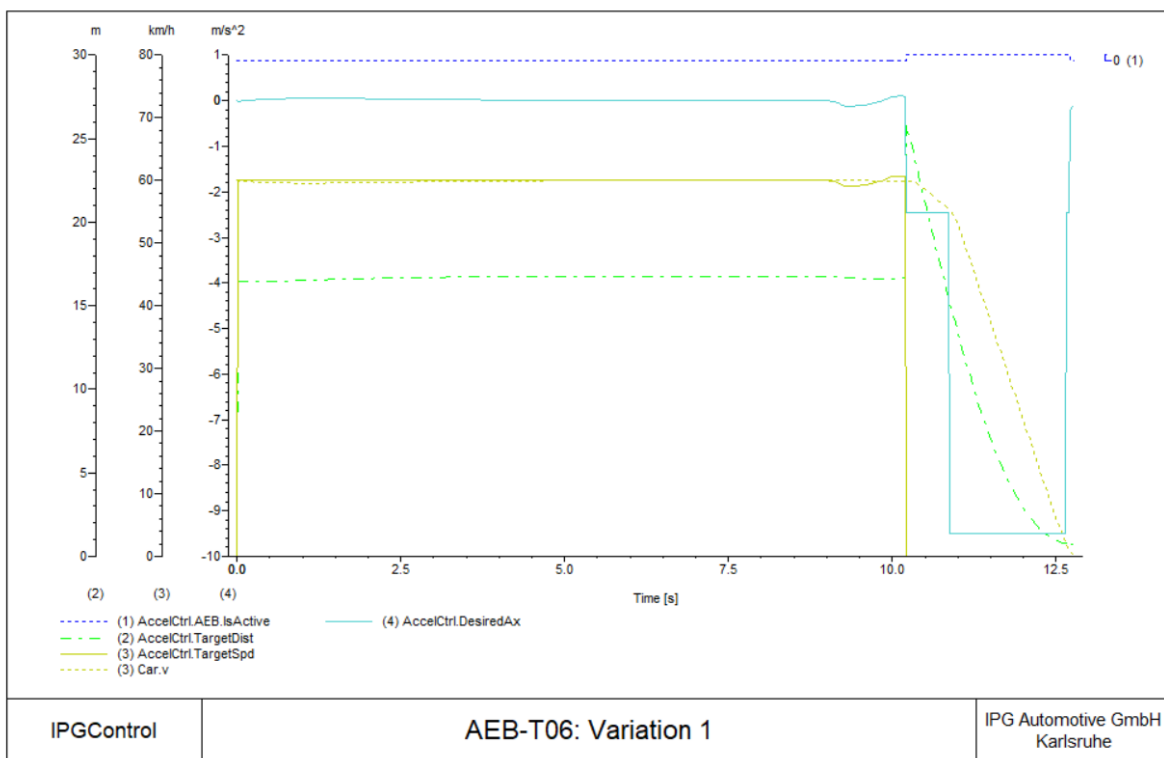
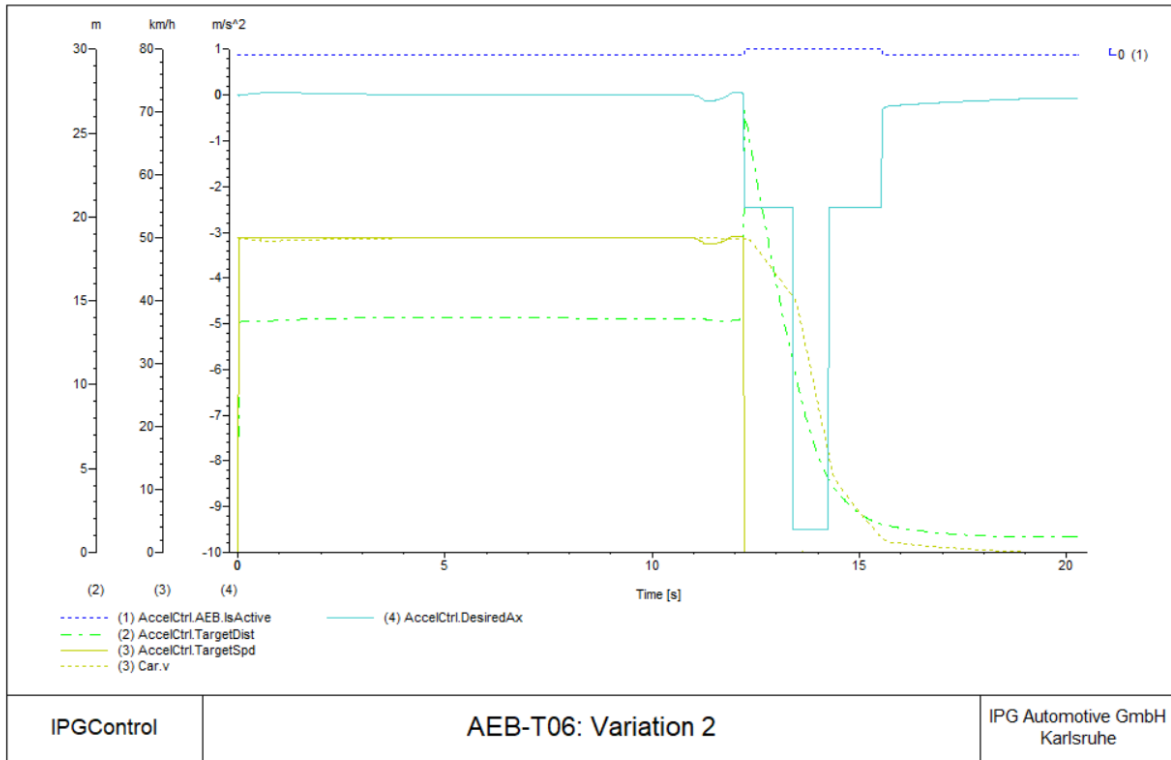
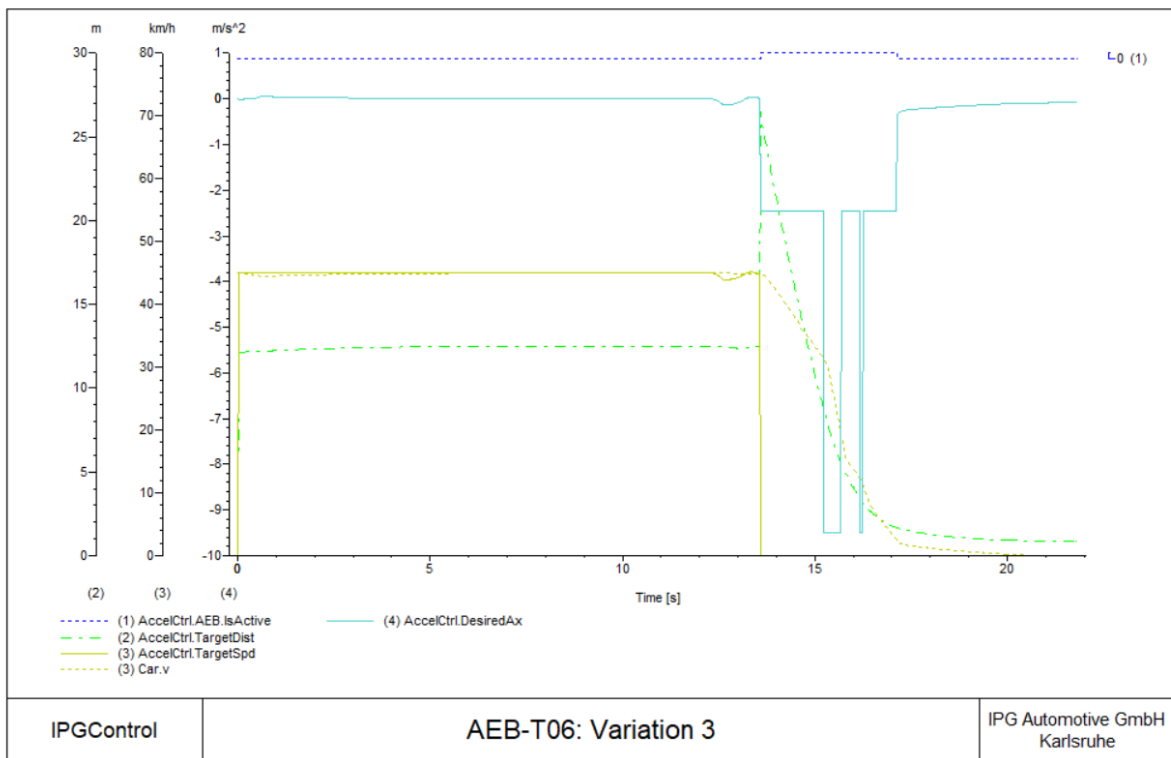

Figure 4.114: AEB-T06 Variation 1 result graph



16.06.18 - 10:55

Figure 4.115: AEB-T06 Variation 2 result graph



16.06.18 - 10:56

Figure 4.116: AEB-T06 Variation 3 result graph

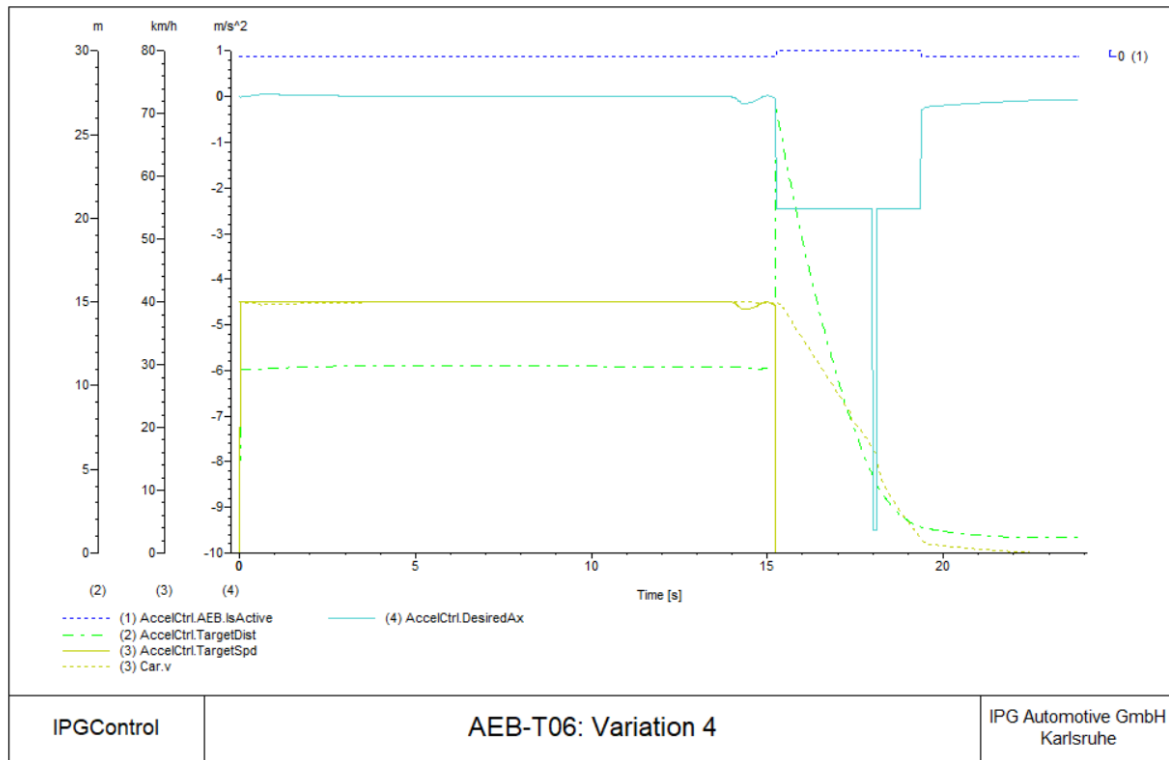

Figure 4.117: AEB-T06 Variation 4 result graph

As it is possible to see, increasing the host vehicle velocity will produce a higher deceleration request (displayed as a solid light blue line), until the AEB activation (displayed as a dotted blue line). This scenario is particularly critical, as in every test the full brake action was required in order to avoid or mitigate the collision. Moreover in all cases it is possible to notice a small negative peak before the sensor detects the stationary vehicle (with the speed displayed as a solid yellow line). This is due to the target vehicle cut-out, which lowers its speed. As soon as the static target is spotted, the AEB intervenes immediately, due to the hazard situation.

To better understand the difference between the various variations, AccelCtrl.DesiredAx and AccelCtrl.TargetDist quantities are reported in Figure 4.118 and Figure 4.119, showing their trend during each test case. The two graphs reproduce the behavior of the previous diagrams, showing that increasing the host car velocity, the VUT will obviously reach the stationary target vehicle earlier and with a higher deceleration request, so that the inter-vehicle distance decreases quicker. In dry road conditions ($C_f = 1$) the Variation 2, 3 and 4 tests end successfully, while in Variation 1 test a minimum inter-vehicle distance of 0.7m has been reached, leading to a warning. On the other hand, the Standard test has a too much higher host vehicle velocity value, resulting in a collision, and so to a fail. However, the impact speed was still decreased to 25.6 km/h, so with an initial speed reduction of 63.4%.

The same test series were also reproduced with a lower friction coefficient ($C_f = 0.5$) simulating a wet road, which AccelCtrl.DesiredAx variations are shown in Figure 4.120, where the results were obviously get worse. In this case, a test pass is present in Variation 4, while in Variation 3 test a minimum inter-vehicle distance of 0.2m has been reached, leading to a warning. Standard, Variation 1 and 2 instead present a collision, resulting to a test fail. However, also in these cases, the impact speed was still decreased to 49.6 km/h, 36.1 km/h and 18.8 km/h, so with an initial speed reduction of 29.1%, 39.8% and 62.4% respectively. As it is possible to notice from the graphs, every failed test Ax trend stops suddenly due to the collision.

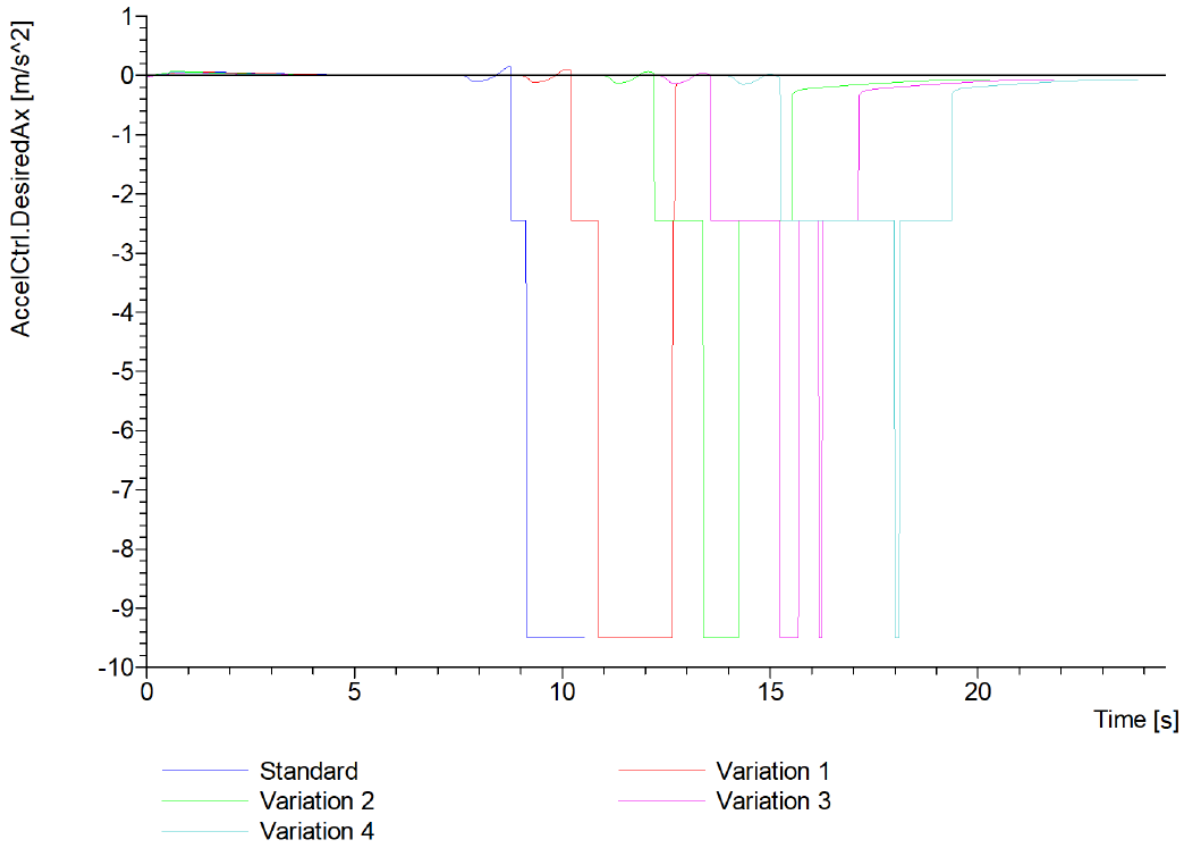

Figure 4.118: AEB-T06 AccelCtrl.DesiredAx variations result graph with $C_f=1$

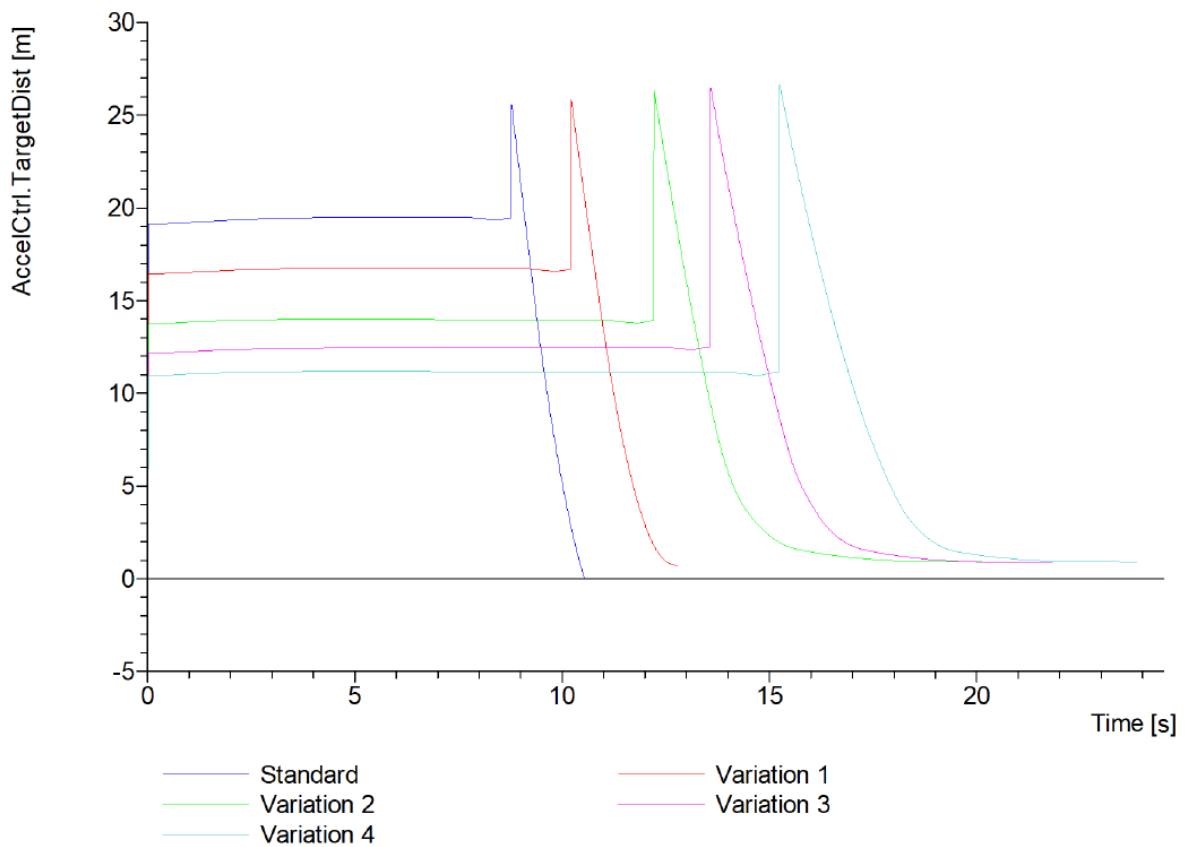

Figure 4.119: AEB-T06 AccelCtrl.TargetDist variations result graph with $C_f=0.5$

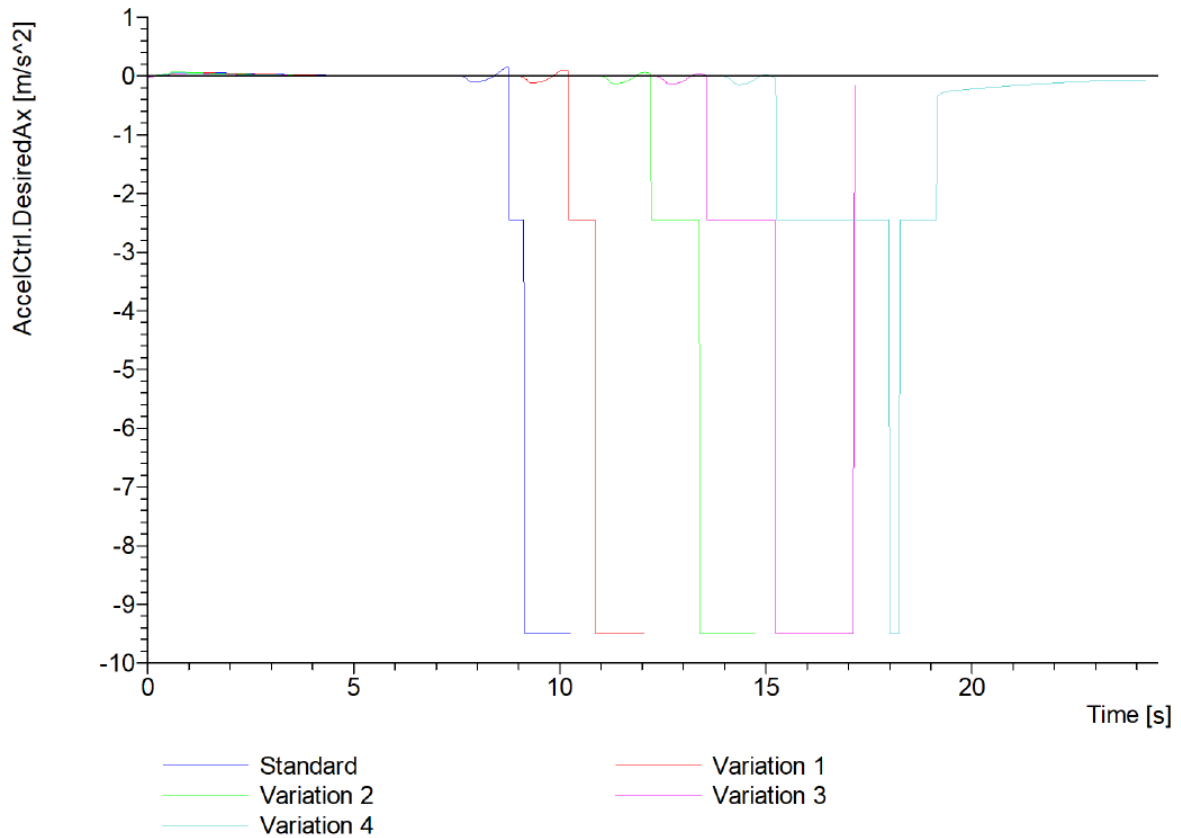

Figure 4.120: AEB-T06 AccelCtrl.DesiredAx variations result graph with Cf=1

4.4.2.7 AEB-T07: Wang paper – Vehicles in column: target vehicle cut-in

The goal of the test is to verify AEB action when a target vehicle cuts in the same lane of the host car. In Figure 4.121 is shown the detailed result chart presented in the CarMaker test manager report, while in the following graphs the quantities trends for each case are reported.

Detailed Results

ID	Test	Result	
		C _f = 1	C _f = 0.5
7	Scenarios/AEB/AEB-T07_Wang_paper		
7.1	Standard	✓	✗
7.2	Variation 1	✓	✓
7.3	Variation 2	✓	⚠
7.4	Variation 3	⚠	✗

Figure 4.121: AEB-T07 test series detailed results

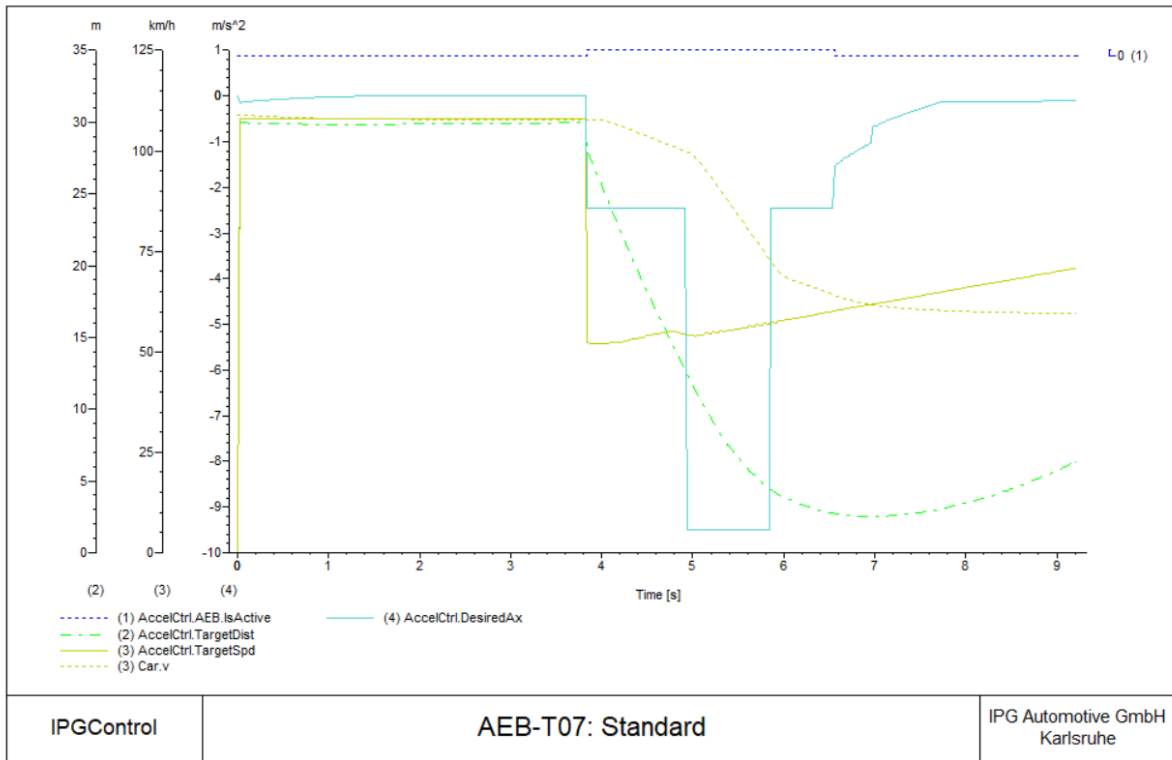

16.06.18 - 12:00

Figure 4.122: AEB-T07 Standard result graph

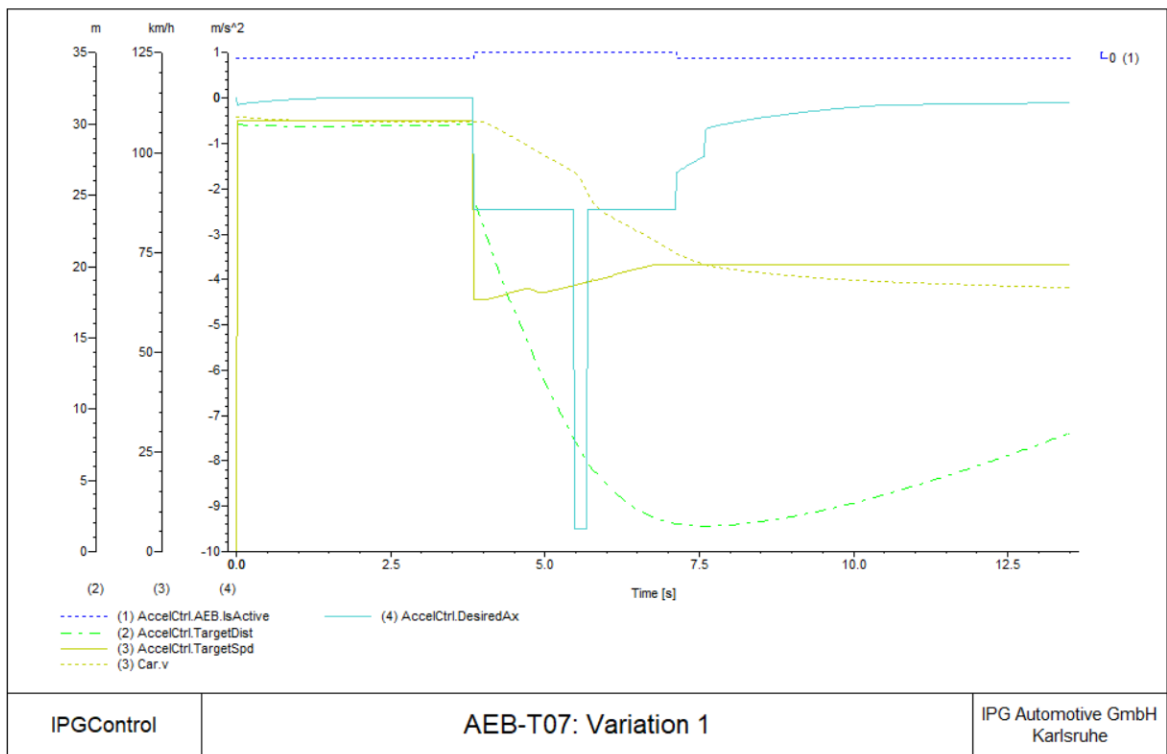

16.06.18 - 12:02

Figure 4.123: AEB-T07 Variation 1 result graph

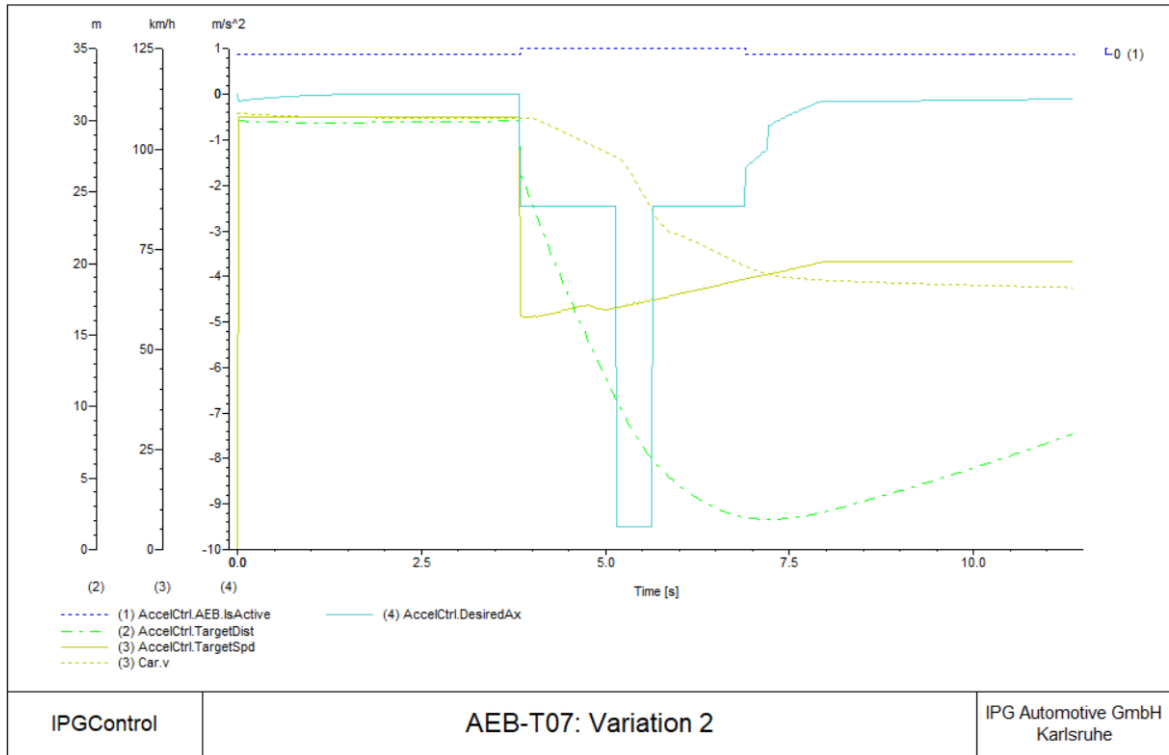

Figure 4.124: AEB-T07 Variation 2 result graph

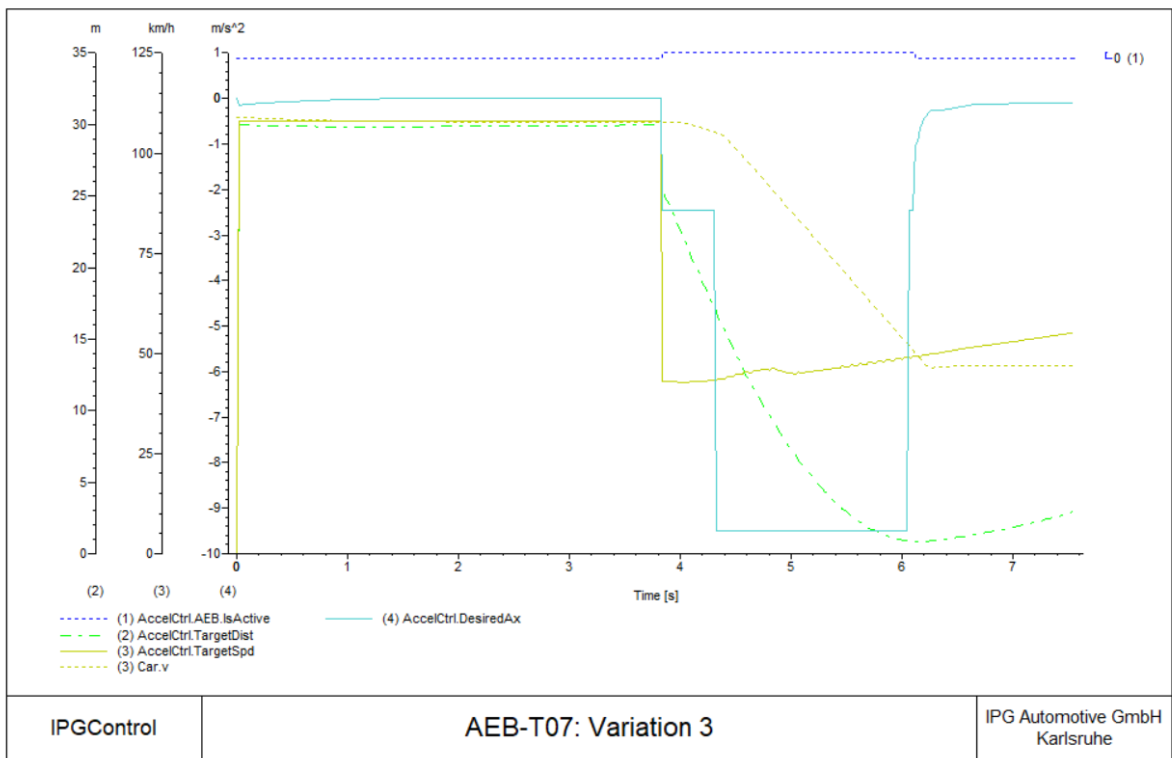

Figure 4.125: AEB-T07 Variation 3 result graph

As it is possible to see, decreasing the target vehicle velocity will produce a raising deceleration request (displayed as a solid light blue line), until the AEB activates (displayed as a dotted blue line). This scenario is particularly critical, as in every test the full brake action was required in order to avoid or mitigate the collision.

Moreover, in all cases it is possible to see how when the sensor detects the new target vehicle (with the speed displayed as a solid yellow line), the AEB intervenes immediately, due to the hazard situation, giving back the control to the ACC system when the TTC gets back under the thresholds values.

To better understand the difference between the various variations, AccelCtrl.DesiredAx and AccelCtrl.TargetDist quantities are reported in Figure 4.126 and Figure 4.127, showing their trend during each test case. The two graphs reproduce the behavior of the previous diagrams, showing that increasing the host car velocity, the VUT will reach the target vehicle position earlier and with a higher deceleration request, so that the distance between the two vehicles reduces quicker, with a lower peak in the worse test (Variation 3).

In dry road conditions ($C_f = 1$) Standard, Variation 1 and 2 tests end successfully, while in Variation 3 test a minimum inter-vehicle distance of 0.8m has been reached, leading to a warning. The same test series were also reproduced with a lower friction coefficient ($C_f = 0.5$) simulating a wet road, which AccelCtrl.DesiredAx variations are shown in Figure 4.128, where the results were slightly worse. In this case, a test pass is present only in Variation 1, while in Variation 2 test a minimum inter-vehicle distance of 0.8m has been reached, leading to a warning. Standard and Variation 3 instead present a collision, resulting to a test fail, as it is possible to notice from the blue and pink lines interruption. However, the impact speed was decreased to 77.1 km/h and 85.3 km/h, so with an initial speed reduction of 28.6% and 21% respectively.

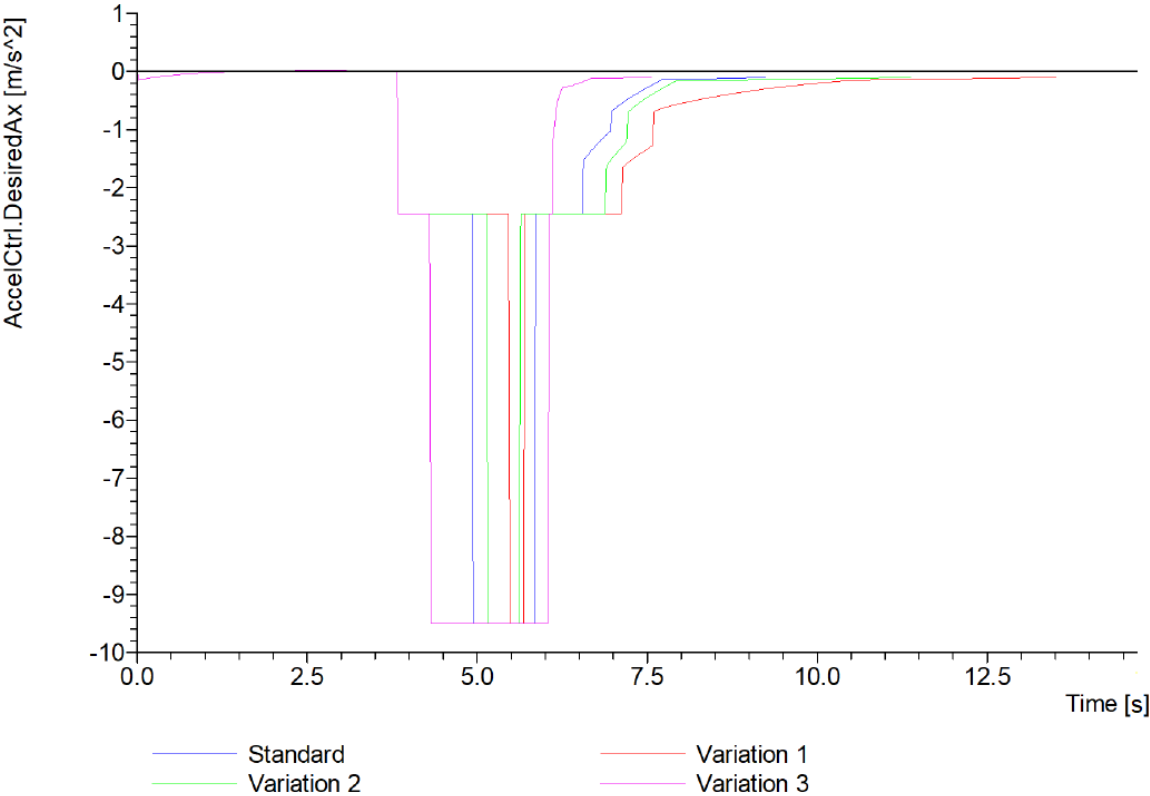

Figure 4.126: AEB-T07 AccelCtrl.DesiredAx variations result graph with $C_f=1$

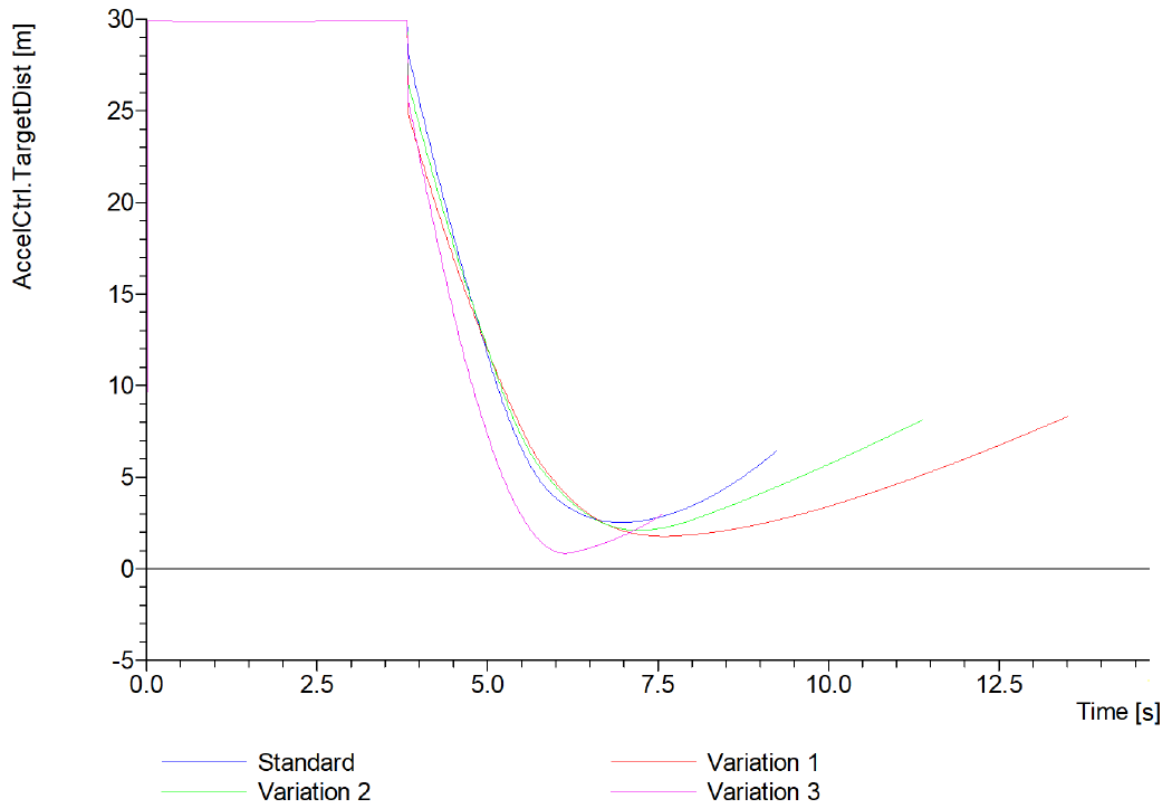

Figure 4.127: AEB-T07 AccelCtrl.TargetDist variations result graph with $C_f=1$

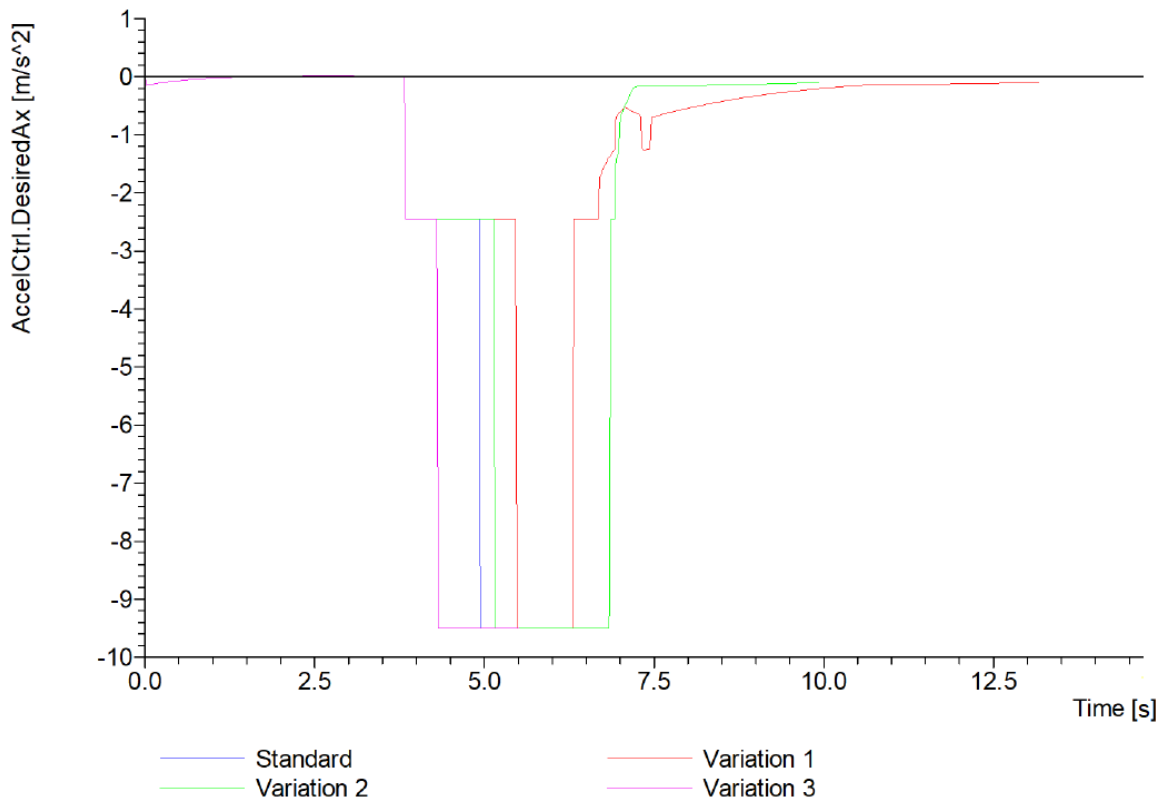

Figure 4.128: AEB-T07 AccelCtrl.DesiredAx variations result graph with $C_f=0.5$

Chapter 5

Conclusions

Advanced Driver Assistance Systems are expected to reduce drivers' workload, improve safety and efficiency of transportation, but, as these systems are the first step for the autonomous driving, they are becoming more and more complex. As a consequence, ADAS must satisfy increasingly stringent reliability and safety requirements to perform in many different conditions.

In this thesis, an overview of ADAS testing was illustrated, analysing the importance of in-the-loop simulations. It was explained the 'V' diagram, focusing on verification and validation phases. The testing methodology was described and the scenarios elements were listed.

A depth analysis about ACC and AEB systems was presented, in particular the benefits and how they work, listing scenarios and critical situations. The second part described the used software, i.e. Simulink and IPG CarMaker. With the first one it was created an ACC and AEB controller, which logic has been fully described, while the latter was used to develop the testing scenarios based on the current standards. In the last part all the driving scenarios were simulated and parametrized, and the results were analysed.

The simulated scenarios tested the implemented ACC and AEB controller based on a pre-set vehicle dynamic and sensor logic provided by the IPG CarMaker software, so in order to evaluate better the results, proper dynamic vehicle and sensor models must be developed, even if it a complex task as it depends on modelling requirements of an actual car. The ACC and AEB controller itself can be improved, considering other factors, as the friction coefficient or the road slope [49]. Moreover, fault-tolerant tests could be implemented to verify the system failures performance introducing disturbances and errors.

Another important issue regarding ADAS equipped vehicles is that of driver situation awareness. Due to increase in automation of vehicle, a human driver's situation awareness of the surrounding environment may decrease, potentially adversely affecting the response during re-engagement due to critical situations or system faults [50]. Therefore, the implementation of a visual/audible warning [17] or an attention detection system [51] is essential to allow the driver to fully assess the situation and reengage in the driving task.

Bibliography

- [1] Anders Cioran (2015). “System Integration Testing of Advanced Driver Assistance Systems”. *KTH royal institute of technology school of electrical engineering, Soodertjaale, Sweden*.
- [2] Olaf Gietelink (2007). “Design and Validation of Advanced Driver Assistance Systems”. *Netherlands TRAIL Research School*.
- [3] Klaus Bengler, Klaus Dietmayer, Berthold Farber, Markus Maurer, Christoph Stiller, Hermann Winner (2014). “Three Decades of Driver Assistance Systems: Review and Future Perspectives”. *IEEE Intelligent Transportation Systems Magazine (Volume: 6, Issue: 4)*.
- [4] Meiyuan Zhao (2015). “Advanced Driver Assistant System - Threats, Requirements, Security Solutions”. *Technical White Paper, Security & Privacy Research, Intel Lab*.
- [5] NHTSA’s National Center for Statistics and Analysis (2015). “Critical reasons for crashes investigated in the national motor vehicle crash causation survey”. *A Brief Statistical Summary, DOT HS 812 115*.
- [6] Ioana Koglbauer, Jürgen Holzinger, Arno Eichberger and Cornelia Lex (2017). “Drivers’ Interaction with Adaptive Cruise Control on Dry and Snowy Roads with Various Tire-Road Grip Potentials”. *Institute of Automotive Engineering, Graz University of Technology, Graz, Austria; AVL List GmbH, Graz, Austria*.
- [7] A. Vahidi and A. Eskandarian (2003). “Research advances in intelligent collision avoidance and adaptive cruise control”. *IEEE Transactions on Intelligent Transportation Systems*.
- [8] L. Nilsson (1995). “Safety effects of adaptive cruise controls in critical traffic situations”. *Proceedings of the Second World Congress on Intelligent Transport Systems*.
- [9] Pratyush Bhatia (2003). “Vehicle Technologies to Improve Performance and Safety”. *UC Berkeley: University of California Transportation Center*.
- [10] Dean Gibson (2017). “Cruise control and adaptive cruise control: the complete guide”. *Autoexpress.co.uk article*.
- [11] Luttinen, R. Tapio (1996). “Statistical Analysis of Vehicle Time Headways”. *Helsinki University of Technology, Transportation Engineering, Publication 87*.

- [12] Silvia Magdici and Matthias Althoff (2017). “Adaptive Cruise Control with Safety Guarantees for Autonomous Vehicles”. *IFAC (International Federation of Automatic Control)*.
- [13] DAF Trucks (2017). “Predictive Cruise Control”. *DAF Trucks N.V. Eindhoven headquarter*.
- [14] Yusuf Kavurucu, Tolga Ensari (2017). “Predictive Cruise Control”. *IEEE Xplore digital library*.
- [15] Robert Pepper (2017). “Autonomous Emergency Braking (AEB) Explained”. *Practicalmotoring.com.au*.
- [16] SAE international (2016). “Taxonomy and Definitions for Terms Related to Driving Automation Systems for On-Road Motor Vehicles”. *SAE J3016_201806*.
- [17] Adit Joshi (2017). "Hardware-in-the-Loop (HIL) Implementation and Validation of SAE Level 2 Autonomous Vehicle with Subsystem Fault Tolerant Fallback Performance for Takeover Scenarios". *SAE Technical Paper 2017-01-1994, 2017, doi:10.4271/2017- 01-1994*.
- [18] Juan Rodriguez (2015). “Ensuring Best Inspection Practice”. *Al Bustan Rotana Hotel workshop*.
- [19] Hermann Kopetz and Stephan Poledna (2013). “Autonomous Emergency Braking: a System-of-Systems Perspective”. *IEEE Xplore digital library*.
- [20] ISO 15622 (2010). “Intelligent transport systems - Adaptive Cruise Control systems - Performance requirements and test procedures”. *Published in Switzerland, Reference number ISO 15622:2010*.
- [21] Alain Piperno (2016). “Homologation et testing des ADAS/véhicules autonomes”. *Brussels Autosens presentation*.
- [22] C. Hôte (2002). “Abstract interpretation techniques for software testing”. *Business Briefing: Global Automotive Manufacturing & Technology*.
- [23] Emmanuel Genty (2017). “Physical and Virtual simulation, a winning combination for autonomous driving “. *Group.renault.com*.
- [24] National Research Council (1998). “Statistics, Testing, and Defense Acquisition: New Approaches and Methodological Improvements”. *Washington, DC: The National Academies Press. https://doi.org/10.17226/6037*.
- [25] Alexander Fasching (2016). “Virtual Prototyping - HW/SW Codesign”. *Vienna University of Technology*.

- [26] Kashyap Vyas (2015). “Can simulation tools replace physical tests completely?”. *Pddnet.com article*.
- [27] X. B. Fan and P. Deng (2013). “Study on the tire/road friction coefficient estimation”. *Auto Engineer*, vol. 12, pp. 47–50.
- [28] R. Rajamani, N. Piyabongkarn, J. Lew (2010). “Tire-road friction coefficient estimation”. *IEEE Control Systems Magazine*, vol. 30, no. 4, pp. 54–69.
- [29] Longhai Yang, Xiqiao Zhang, Jiekun Gong, and Juntao Liu (2015). “The Research of Car-Following Model Based on Real-Time Maximum Deceleration”. *School of Transportation Science and Engineering, Harbin Institute of Technology, Harbin 150090, China*.
- [30] M. Rimini-Döring (Robert Bosch GmbH), A. Keinath (BMW), E. Nodari, F. Palma, A. Toffetti (CRF), N. Floudas (ICCS), E. Bekiaris, V. Portouli, M. Panou (HIT) (2015). “Aide (Adaptive Integrated Driver-vehicle Interface) considerations on Test Scenarios”. *Information Society Technologies (IST) programme*.
- [31] B.S. Kerner (2009). “Introduction to Modern Traffic Flow Theory and Control”. *Springer-Verlag Berlin Heidelberg, Chapter 2, DOI 10.1007/978-3-642-02605-8*.
- [32] EuroNCAP test protocol – AEB systems. *Version 2.0.1, November 2017*.
- [33] Wesley Hulshof, Iain Knight, Alix Edwards, Matthew Avery, Colin Grover (2013). “Autonomous emergency braking test results”. *Thatcham Research, UK, Paper Number 13-0168*.
- [34] IPG Automotive GmbH (2015). “Brochure about CarMaker, TruckMaker and MotorcycleMaker”. *Bannwaldallee 60, 76185 Karlsruhe, ipg-automotive.com*.
- [35] ACI (Italian Automobile Club) (1992). “Art. 149. of New road codex - safety distance between vehicles. Decree of the President of the Republic 16 December 1992, n. 495.
- [36] IPG CarMaker (2017). “Reference Manual – Version 6.0”. *Bannwaldallee 60, 76185 Karlsruhe, ipg-automotive.com*.
- [37] Ding Zhao, Henry Lam, Huei Peng, Shan Bao, David J. LeBlanc, Kazutoshi Nobukawa, and Christopher S. Pan (2017). “Accelerated Evaluation of Automated Vehicles Safety in Lane-Change Scenarios Based on Importance Sampling Techniques”. *IEEE Transactions on intelligent transportation systems*, vol. 18, no. 3, March 2017 595.

- [38] Moeckli, J., Brown, T., Dow, B., Boyle, L.N., Schwarz, C., & Xiong, H. (2015). "Evaluation of adaptive cruise control interface requirements on the National Advanced Driving Simulator". (*Report No. DOT HS 812 172*). Washington, DC: National Highway Traffic Safety Administration.
- [39] Nilsson, J., Strand, N., Falcone, P. (2013). "Driver performance in the presence of adaptive cruise control related failures: Implications for safety analysis and fault tolerance". *2013 43rd Annual IEEE/IFIP Conference on Dependable Systems and Networks Workshop (DSN-W)* pp. 1-10.
- [40] European Commission (2009). "Explanation of the draft regulation on automatic emergency braking". *AEBS/LDWS-01-06, Transmitted by Expert from Japan*
- [41] Chen, Q., Lin, M., Dai, B., and Chen, J. (2015). "Typical Pedestrian Accident Scenarios in China and Crash Severity Mitigation by Autonomous Emergency Braking Systems". *SAE Technical Paper 2015-01-1464*, 2015, doi:10.4271/2015-01-1464.
- [42] Erik Rosén (2013). "Autonomous Emergency Braking for Vulnerable Road Users". *IRC-13-71 IRCOBI Conference 2013*.
- [43] Patrik Zita (2017). "Simulation of AEB system testing". *Czech Technical University in Prague, Faculty of Mechanical Engineering*.
- [44] NHTSA's National Center for Statistics and Analysis (1998). "Intelligent Cruise Control Field Operational Test". *Volume I: Technical Report, DOT HS 808 849*.
- [45] Jinwei Zhou, Luigi del Re (2017). "Reduced Complexity Safety Testing for ADAS & ADF". *Institute for Design and Control of Mechatronical System, Johannes Kepler University Linz, 4040 Linz, Austria*.
- [46] European Commission (2012). "Implementing Regulation (EC) No 661/2009 of the European Parliament and of the Council with respect to type-approval requirements for certain categories of motor vehicles with regard to advanced emergency braking systems". *Commission regulation No 347/2012, Brussels*.
- [47] Martin Hykš (2014). "Detection of barriers in active and integrated safety systems". *Czech Technical University in Prague, Faculty of transportation Sciences*.
- [48] Wei-Jen Wang (2017). "Design of an Adaptive Cruise Control and Collision Avoidance with Lane Keeping System Support for Vehicle Assistance Driving". *Automotive Research & Testing Center, Taiwan*.
- [49] Ming Lin, Jaewoo Yoon and Byeongwoo Kim (2015). "A Study and Analysis for Calculating the Brake-application Time of AEB Systems Considering the Gradient". *International Journal of Control and Automation Vol. 8, No. 6 (2015), pp. 283-292*.

- [50] Mark Vollratha, Susanne Schleicherb, Christhard Gelauc (2010). “The influence of Cruise Control and Adaptive Cruise Control on driving behaviour – A driving simulator study”. *Department of Traffic and Engineering Psychology, TU Braunschweig, Gausstr. 23, D-38106 Braunschweig, Germany; Lehrstuhl für Versorgungssystemforschung und Grundlagen der Qualitätssicherung in der Rehabilitation, Luisenstr. 13 A, D-10117 Berlin, Germany; Bundesanstalt für Straßenwesen, Brüderstraße 53, D-51427 Bergisch Gladbach, Germany.*
- [51] Philipp Wehner, Fynn Schwiegelshohn, Diana Göhringer, Michael Hübner (2014). “Development of Driver Assistance Systems using virtual Hardware-in-the-Loop”. *Ruhr-University Bochum, Germany.*
- [52] European Commission (2007). “Directive 2007/46/EC of the European Parliament and of the Council establishing a framework for the approval of motor vehicles and their trailers, and of systems, components and separate technical units intended for such vehicles”. *Commission regulation 2007/46, Brussels.*

Appendix

European Union Regulation No. 347/2012 describes five scenarios to validate the AEB system for M2, M3, N2 and N3 vehicles. Table 1 describes the vehicle category and Table 2 and 3 the Approval level 1 and 2 requirements.

Category	Description
M2	Vehicles used for the carriage of passengers, comprising more than eight seats in addition to the driver's seat, and having a maximum mass not exceeding 5 tonnes. (Bus)
M3	Vehicles used for the carriage of passengers, comprising more than eight seats in addition to the driver's seat, and having a maximum mass exceeding 5 tonnes. (Bus)
N2	Vehicles used for the carriage of goods and having a maximum mass exceeding 3.5 tonnes but not exceeding 12 tonnes. (Commercial Truck)
N3	Vehicles used for the carriage of goods and having a maximum mass exceeding 12 tonnes. (Commercial Truck)

Table 1: Vehicle category classification [52]

Approval level 1: activation test requirements - pass/fail values

Vehicle category	Stationary target	Moving Target at 32 ± 2 km/h
M3, N3 and N2 > 8 t (equipped with pneumatic or air over hydraulic braking systems and with pneumatic rear axle suspension systems)	Speed reduction of subject vehicle not less than 10 km/h	Subject vehicle shall not impact with the moving target

Table 2: Approval level 1 requirements [46]

Approval level 2: activation test requirements - pass/fail values

Vehicle category	Stationary target	Moving Target at 12 ± 2 km/h
M3, N3 and N2 > 8 t ⁽¹⁾	Speed reduction of subject vehicle not less than 20 km/h	Subject vehicle shall not impact with the moving target
N2 < 8 t and M2 ⁽²⁾	Values to be specified	Values to be specified

Table 3: Approval level 2 requirements [46]

⁽¹⁾ Vehicles of category M3 with hydraulic braking system are subject to the requirements of the second row.

⁽²⁾ Vehicles with pneumatic braking system are subject to the requirements of the first row.